

SPECIFICATIONS

WORKSHOP

MOULDED CASE
CIRCUIT BREAKERS

DPX³ 160 & 250

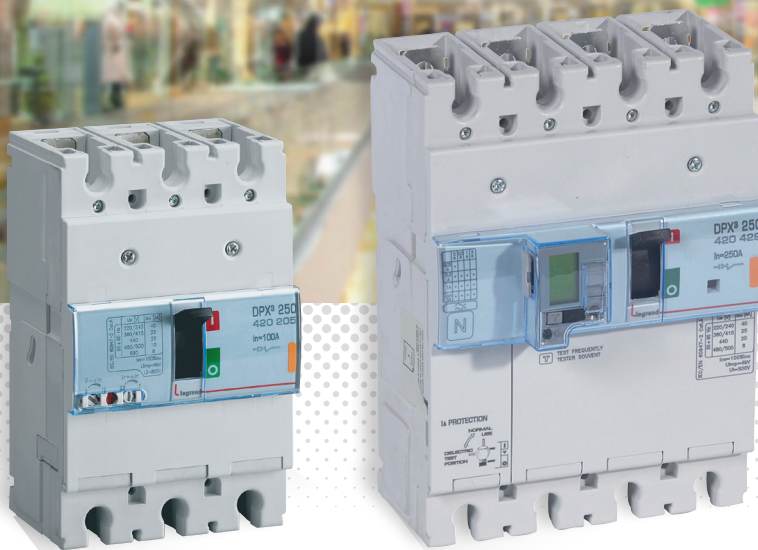

Not only do **DPX³ 160** and **DPX³ 250** MCCBs provide precise, reliable protection, they also offer numerous benefits for your low voltage distribution boards. The wide choice of characteristics and versions meets the most demanding requirements for electrical installations in commercial, service sector and industrial applications.

The integrated measurement function allows you to monitor your installation's parameters and consumption levels without the need for a current transformer or any additional voltage measurement input.

The different **selectivity** techniques available ensure optimum **continuity of service**.

Operation and **maintenance** is made easy by the comprehensive range of electrical and mechanical auxiliaries.

Total compatibility with Legrand enclosures simplifies panel design using XLPRO³ and installation by panel builders.

Numerous accessories are available to enable adaptation to any panel configuration.

Read on to discover all you need to know about DPX³ 160/250 MCCBs and their benefits.

LEGAL INFORMATION

Presentation pictures do not always include Personal Protective Equipment (PPE), but this is a legal and regulatory obligation that must be scrupulously respected.

In accordance with its continuous improvement policy, Legrand reserves the right to change the specifications and illustrations without notice. All illustrations, descriptions and technical information included in this document are provided as indications and cannot be held against Legrand.

TABLE OF CONTENTS

Safety instructions	2-3
The DPX³ range	
Presentation of the offer	4-5
DPX ³ 160 - DPX ³ -I 160 - DPX ³ 160 MS	6-7
DPX ³ 250 - DPX ³ -I 250 - DPX ³ 250 AB - DPX ³ 250 MS	8-9
DPX³ 160	
Product description	10 to 12
DPX ³ 160 electrical accessories	13 to 17
DPX ³ 160 mechanical accessories	18 to 31
DPX ³ 160 connections	32 to 37
DPX³ 250	
Product description	38 to 41
DPX ³ 250 electrical accessories	42 to 45
DPX ³ 250 mechanical accessories	46-47
Connections	48-49
Installing the devices	50-51
PCS software	52-55
Dedicated functions	
Integrated measurement	56-57
Coordination	58-59
Common accessories	
Auxiliary contact function - Cat.no 4 210 11	60
Shunt trip function	61
Undervoltage release function	62
Time lag (800 ms) undervoltage release Cat.no 4 210 98	63
Motor operator function	64-65
Supply inverter	66
Integrated residual current protection function	67-68
Residual current relay function - Cat.no 0 260 88	69-70
Spare parts & accessories	72-73

SAFETY

INSTRUCTIONS

General information

- Use only the products and accessories recommended by the Legrand Group in the catalogue, instructions, technical data sheets and all other documents provided by Legrand (hereinafter referred to as «the Documentation») in compliance with the installation rules.
- Improper installation and/or use may result in the risk of arcing in the enclosure, overheating or fire. The enclosures must be used under normal conditions, they must not be subjected to Voltage / Current / Temperature values other than those specified in the Documentation.
- Legrand declines all responsibility for any modification or repair of the equipment making up the enclosure that is not authorized by the Legrand Group, as well as any failure to comply with the rules and recommendations specified by Legrand in the Documentation. In addition, in the cases mentioned above, the warranty granted by Legrand will not be applicable.
- It is necessary to check that the characteristics of the products are appropriate for their environment and use during maintenance operations, and to refer to the Documentation. If you have any questions or require clarification, please contact Legrand Group.
- The installation, use and maintenance of the enclosures and their components must be carried out by qualified, trained and authorized personnel, in accordance with the regulations in force in each country.



RISK OF ELECTRIC SHOCK, BURNS AND EXPLOSION.

- People working on the installation must have the appropriate electrical authorizations for the work to be carried out.
- Wear the PPE (Personal Protective Equipment) necessary to work on live products.
- Respect the safety rules related to electrical work.
- Improper electrical and mechanical use of equipment can be dangerous and may result in personal injury or damage to property.
- Depending on the maintenance operations to be carried out, partial or total power cuts of the enclosure concerned should be planned before any work.
- When performing operations that involve access to the inside of the enclosure, be aware of the risk of burns before touching any products or metal parts.
- Before turning the power back on, make sure that there are no foreign bodies and that all physical protections have been put back in place (e.g.: screens, covers, shields).

Any failure to strictly apply the procedures and to respect these recommendations, could lead to serious risk of accident, endangering people and property (in particular, without limitation, risk of burns, electric shocks, etc.).



! The rules and recommendations in this document are based on our knowledge of the typical conditions of use of our products in the fields of application usually encountered. However, it is always the customer's responsibility to verify and validate that Legrand products are suitable for its installation and use.

The customer must ensure proper installation, maintenance and operation of the equipment to avoid any risk of injury to personnel or damage to property in the event of product failure, especially for applications that require a very high level of safety (e.g., those in which the failure of a component may endanger human life or health).

The rules for storage, handling, installation and maintenance and the appropriate precautions and warnings must be strictly observed and applied.

THE DPX³ RANGE

Presentation of the offer

The key strengths of DPX³ 160 and DPX³ 250 MCCBs lie in their compact dimensions, ease of installation and use, comprehensive range of accessories and their reliability.

DPX³ 160 and DPX³ 250 MCCBs are available in thermal-magnetic and electronic versions with nominal currents ranging from 16 A to 250 A and breaking capacities ranging from 16 kA to 70 kA.

They can be installed on a plate or DIN rail using the fixing plates cat.nos 4 210 68/69/61/71/72/73/74. Their design allows them to be combined with modular faceplates.

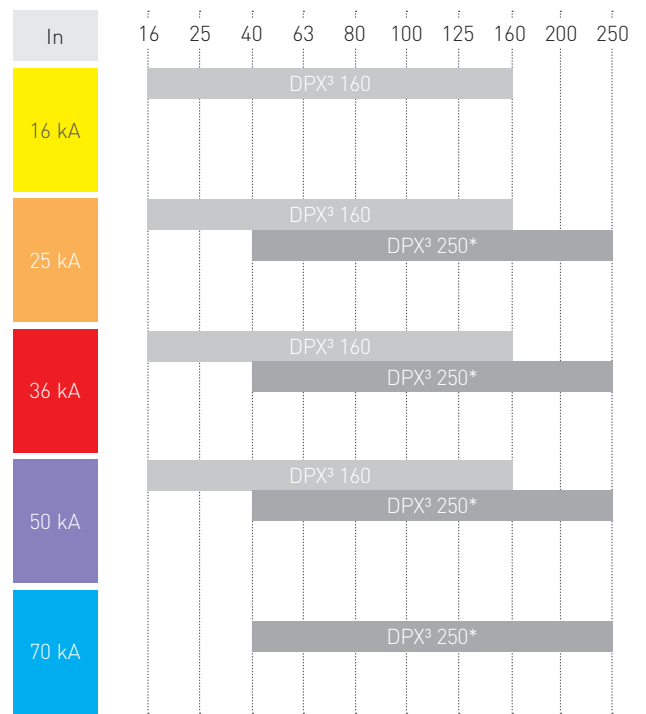

* 40 A: electronic version only, MT starts at 100 A



DPX³ 160
DIN rail or panel
mounted



DPX³ 250
DIN rail or panel
mounted

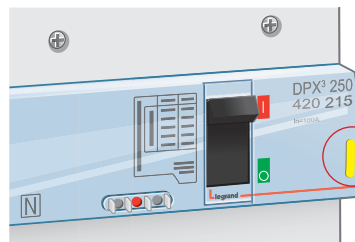

Easy identification of breaking capacity by coloured tab:





The DPX³ 160 and 250 range offers a wide choice of versions to meet all requirements:

- Thermal-magnetic and electronic releases depending on the level of protection required.
- Fixed or plug-in versions depending on the level of maintenance required.
- MCCBs with electronic earth leakage module for protection of people.

DPX³-I 160 and 250 trip-free switches are available in 3P, 4P and 4P with earth leakage module (e.l.c.b.) versions.

MCCB		DPX ³ 160	DPX ³ 250
Number of poles	3 P	●	●
	4 P	●	●
Version	Fixed	●	●
	Plug-in	●	●
Release	Thermal-magnetic	●	●
	Electronic	●	●
	Magnetic only	●	●
Options	Integrated residual current protection	●	●
	Earth fault protection	●	● ⁽¹⁾
	Integrated measurement	●	● ⁽¹⁾

1 : Electronic only

TRIP-FREE SWITCHES		DPX ³ -I 160	DPX ³ -I 250
Number of poles	3 P	●	●
	4 P	●	●
	4 P with earth leakage module	●	●
Version	Fixed	●	●
	Plug-in	●	●

THE DPX³ RANGE

DPX³ 160 - DPX³-I 160 - DPX³ 160 MS

PRESENTATION

The overall design and compact dimensions of DPX³ 160 MCCBs means they can be:

- On rail
- With a faceplate with a modular window
- On plate in vertical or horizontal position.

DPX³ 160 MCCBs provide protection, disconnection, control and isolation for power lines.

Only available with a thermal-magnetic release, DPX³ 160 MCCBs offer:

- 8 ratings: 16 A, 25 A, 40 A, 63 A, 80 A, 100 A, 125 A, 160 A
- 4 breaking capacities: 16 kA, 25 kA, 36 kA, 50 kA
- 3P, 3P+N/2, 4P and 4P with earth leakage module versions.

DPX³ 160 MS (magnetic only) MCCBs provide protection (against short circuits), disconnection, control and isolation of motors. They offer:

- 2 breaking capacities: 16 kA, 25 kA
- 4 ratings: 16 A, 25 A, 50 A, 63 A
- 3P version only.

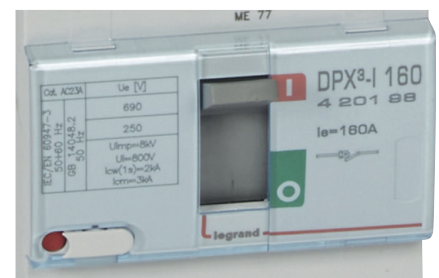

i DPX³-I trip-free switches can be easily identified by their grey switch handle.

DPX³-I 160 trip-free switches provide on-load breaking and isolation of electrical circuits.

They offer:

- a single rating: 160 A
- 3P, 4P and 4P with earth leakage module versions.

LIST OF CATALOGUE NUMBERS

DPX ³ 160 - THERMAL-MAGNETIC																				
Rating	16 kA					25 kA					36 kA					50 kA				
	3P	3P+N/2	4P	3P+N e.l.c.b.	4P e.l.c.b.	3P	3P+N/2	4P	3P+N e.l.c.b.	4P e.l.c.b.	3P	3P+N/2	4P	3P+N e.l.c.b.	4P e.l.c.b.	3P	3P+N/2	4P	3P+N e.l.c.b.	4P e.l.c.b.
16 A	4 200 00	-	4 200 10	-	4 200 30	4 200 40	-	4 200 50	-	4 200 70	4 200 80	-	4 200 90	-	4 201 10	4 201 20	-	4 201 30	-	4 201 50
25 A	4 200 01	-	4 200 11	-	4 200 31	4 200 41	-	4 200 51	-	4 200 71	4 200 81	-	4 200 91	-	4 201 11	4 201 21	-	4 201 31	-	4 201 51
40 A	4 200 00	-	4 200 12	-	4 200 32	4 200 42	-	4 200 52	-	4 200 72	4 200 82	-	4 200 92	-	4 201 12	4 201 22	-	4 201 32	-	4 201 52
63 A	4 200 03	-	4 200 13	-	4 200 33	4 200 43	-	4 200 53	-	4 200 73	4 200 83	-	4 200 93	-	4 201 13	4 201 23	-	4 201 33	-	4 201 53
80 A	4 200 04	-	4 200 14	-	4 200 34	4 200 44	-	4 200 54	-	4 200 74	4 200 84	-	4 200 94	-	4 201 14	4 201 24	-	4 201 34	-	4 201 54
100 A	4 200 05	-	4 200 15	-	4 200 35	4 200 45	-	4 200 55	-	4 200 75	4 200 85	-	4 200 95	-	4 201 15	4 201 25	-	4 201 35	-	4 201 55
125 A	4 200 06	4 207 34	4 200 16	4 207 35	4 200 36	4 200 46	4 207 38	4 200 56	4 207 39	4 200 76	4 200 86	4 207 42	4 200 96	4 207 43	4 201 16	4 201 26	4 207 46	4 201 36	4 207 47	4 201 56
160 A	4 200 07	4 207 36	4 200 17	4 207 37	4 200 37	4 200 47	4 207 40	4 200 57	4 207 41	4 200 77	4 200 87	4 207 44	4 200 97	4 207 45	4 201 17	4 201 27	4 207 48	4 201 37	4 207 49	4 201 57

DPX ³ 160 MS - MAGNETIC ONLY		
Rating	16 kA	25 kA
	3P	3P
16 A	4 207 10	4 207 14
25 A	4 207 11	4 207 15
50 A	4 207 12	4 207 16
63 A	4 207 13	4 207 17

DPX ³ -I 160			
Rating	3P	4P	4P e.l.c.b.
160 A	4 201 98	4 201 99	4 201 97

DPX³ 250 - DPX³-I 250 - DPX³ 250 AB DPX³ 250 MS

PRESENTATION

The overall design and compact dimensions of DPX³ 250 MCCBs means they can be:

- rail mounted with a faceplate with a modular window
- panel mounted.

DPX³ 250 thermal-magnetic MCCBs provide protection, disconnection, control and isolation for power circuits. DPX³ 250 thermal-magnetic MCCBs offer:

- 4 breaking capacities: 25 kA, 36 kA, 50 kA, 70 kA
- 4 ratings: 100 A, 160 A, 200 A, 250 A
- 3P, 4P and 4P with earth leakage module versions.

DPX³ 250 electronic MCCBs (with and without integrated measurement/earth fault protection/earth leakage module) provide protection, disconnection, control and isolation of power lines. DPX³ 250 electronic MCCBs offer:

- 4 breaking capacities: 25 kA, 36 kA, 50 kA, 70 kA
- 4 ratings: 40 A, 100 A, 160 A, 250 A
- 3P, 3P+N/2, 4P and 4P earth leakage module versions (except with earth fault protection).

DPX³ 250 MS (magnetic only) MCCBs provide protection (against short circuits), disconnection, control and isolation of motors. They offer:

- 2 breaking capacities: 36 kA, 70 kA
- 4 ratings: 100 A, 160 A, 200 A, 250 A
- 3P version only.

DPX³-I 250 trip-free switches provide on-load breaking and isolation of electrical circuits. They offer:

- a single rating: 250 A
- 3P, 4P and 4P earth leakage module versions.

DPX³ 250 AB incomer MCCBs provide protection, disconnection, control and isolation of an electric utility's monitored power system. They offer:

- 2 ratings: 130 A, 240 A
- 4P and 4P with earth leakage module versions.



DPX³-I trip-free switches can be easily identified by their grey switch handle.



LIST OF CATALOGUE NUMBERS

DPX ³ 250 - THERMAL-MAGNETIC																				
Rating	25 kA					36 kA					50 kA					70 kA				
	3P	3P+N/2	4P	3P+N/2 e.l.c.b.	4P e.l.c.b.	3P	3P+N/2	4P	3P+N/2 e.l.c.b.	4P e.l.c.b.	3P	3P+N/2	4P	3P+N/2 e.l.c.b.	4P e.l.c.b.	3P	3P+N/2	4P	3P+N/2 e.l.c.b.	4P e.l.c.b.
100 A	4 202 05	-	4 202 15	-	4 202 25	4 202 35	-	4 202 45	-	4 202 55	4 202 65	-	4 202 75	-	4 202 85	4 206 05	-	4 206 15	-	4 206 25
160 A	4 202 07	-	4 202 17	-	4 202 27	4 202 37	-	4 202 47	-	4 202 57	4 202 67	-	4 202 77	-	4 202 87	4 206 07	-	4 206 15	-	4 206 27
200 A	4 202 08	-	4 202 18	-	4 202 28	4 202 38	-	4 202 48	-	4 202 58	4 202 68	-	4 202 78	-	4 202 88	4 206 08	-	4 206 18	-	4 206 28
250 A	4 202 09	4 207 50	4 202 19	4 207 51	4 202 29	4 202 39	4 207 52	4 202 49	4 207 53	4 202 59	4 202 69	4 207 54	4 202 79	4 207 55	4 202 89	4 206 09	4 207 56	4 206 19	4 207 57	4 206 29

DPX ³ -I 250			
Rating	3P	4P	4P e.l.c.b.
250 A	4 202 99	4 203 00	4 202 98

DPX ³ 250 - ELECTRONIC												
Rating	25 kA			36 kA			50 kA			70 kA		
	3P	4P	4P e.l.c.b.	3P	4P	4P e.l.c.b.	3P	4P	4P e.l.c.b.	3P	4P	4P e.l.c.b.
40 A	4 203 02	4 203 12	4 203 22	4 203 32	4 203 42	4 203 52	4 203 62	4 203 72	4 203 82	4 206 35	4 206 45	4 206 55
100 A	4 203 05	4 203 15	4 203 25	4 203 35	4 203 45	4 203 55	4 203 65	4 203 75	4 203 85	4 206 37	4 206 47	4 206 57
160 A	4 203 07	4 203 17	4 203 27	4 203 37	4 203 47	4 203 57	4 203 67	4 203 77	4 203 87	4 206 38	4 206 48	4 206 58
250 A	4 203 09	4 203 19	4 203 29	4 203 39	4 203 49	4 203 59	4 203 69	4 203 79	4 203 89	4 206 39	4 206 49	4 206 59

DPX ³ 250 - ELECTRONIC - MEASUREMENT												
Rating	25 kA			36 kA			50 kA			70 kA		
	3P	4P	4P e.l.c.b.	3P	4P	4P e.l.c.b.	3P	4P	4P e.l.c.b.	3P	4P	4P e.l.c.b.
40 A	4 204 02	4 204 12	4 204 22	4 204 32	4 204 42	4 204 52	4 204 62	4 204 72	4 204 82	4 206 65	4 206 75	4 206 85
100 A	4 204 05	4 204 15	4 204 25	4 204 35	4 204 45	4 204 55	4 204 65	4 204 75	4 204 85	4 206 67	4 206 77	4 206 87
160 A	4 204 07	4 204 17	4 204 27	4 204 37	4 204 47	4 204 57	4 204 67	4 204 77	4 204 87	4 206 68	4 206 78	4 208 88
250 A	4 204 09	4 204 19	4 204 29	4 204 39	4 204 49	4 204 59	4 204 69	4 204 79	4 204 89	4 206 69	4 206 79	4 206 89

DPX ³ 250 SG - ELECTRONIC + EARTH FAULT PROTECTION									DPX ³ 250 MS - MAGNETIC ONLY			
Rating	25 kA			36 kA		50 kA		70 kA		Rating	3P	
	3P	4P	4P e.l.c.b.	3P	4P	3P	4P	3P	4P		36 kA	70 kA
40 A	4 205 02	4 205 12	4 205 22	4 205 32	4 205 42	4 205 52	4 206 92	4 207 02	100 A	4 207 18	4 207 22	
100 A	4 205 05	4 205 15	4 205 25	4 205 35	4 205 45	4 205 55	4 206 95	4 207 05	160 A	4 207 19	4 207 23	
160 A	4 205 07	4 205 17	4 205 27	4 205 37	4 205 47	4 205 57	4 206 97	4 207 07	200 A	4 207 20	4 207 24	
250 A	4 205 09	4 205 19	4 205 29	4 205 39	4 205 49	4 205 59	4 206 99	4 207 09	250 A	4 207 21	4 207 25	

Rating	DPX ³ 250 AB	
	4P	4P e.l.c.b.
130 A	4 207 30	4 207 31
240 A	4 207 32	4 207 33

DPX³ 160

Product description

1 CIRCUIT BREAKER FRONT PANEL

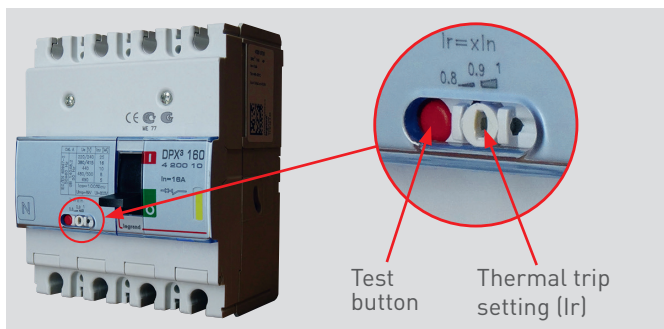

DPX³ 160 thermal-magnetic MCCB.

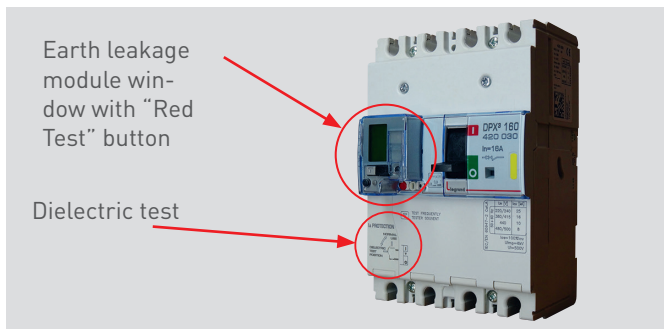

DPX³ 160 thermal-magnetic MCCB with earth leakage module.

2 TRIP-FREE SWITCH FRONT PANEL

The switch handles on the trip-free switches are grey to differentiate them from the circuit breakers, which have black handles.



The settings can be sealed using the kit Cat.No 4 210 95.

3 POSITION OF SWITCH HANDLE (ON - TRIPPED - OFF)

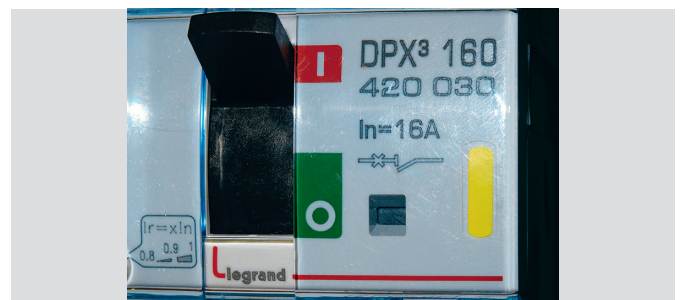

CLOSED (ON).

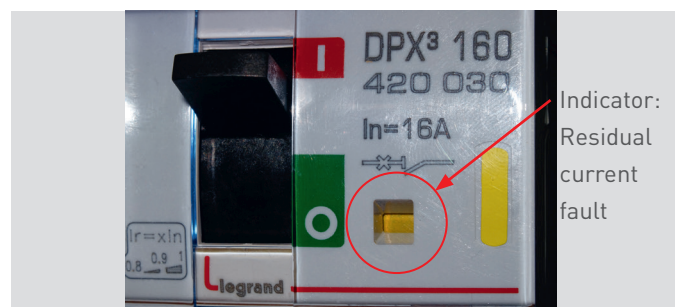

Tripped.

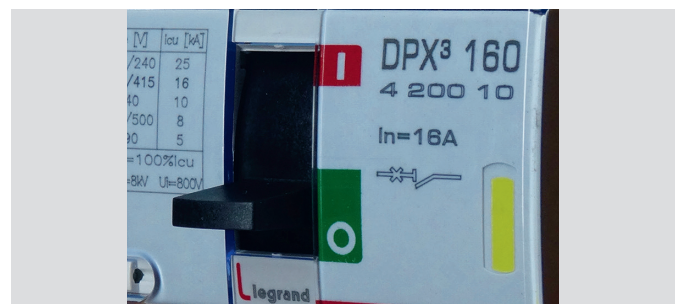

OPEN (OFF).

4 SETTINGS (THE DEVICE MUST BE TRIPPED)

For DPX³ 160 thermal-magnetic MCCBs.

Thermal : I _r		Rating							
I _n multiplication factor	Marking	16	25	40	63	80	100	125	160
0,8	0,8	12,8	20	32	50,4	64	80	100	128
0,9	0,9	14,4	22,5	36	56,7	72	90	112,5	144
1	1	16	25	40	63	80	100	125	160
Neutral*		16	25	40	63	63	63	80	100

*Only international version

I_r values at ± 20% in amps at 40°C / 50°C.

Magnetic : I _i	16	25	40	63	80	100	125	160
Fixed	400		630	800	1000	1250	1600	

I_i values at ± 20% in amps at 40°C / 50°C.

Only those settings corresponding to positions with an engraved marking are tested. The other values are given for information purposes only.

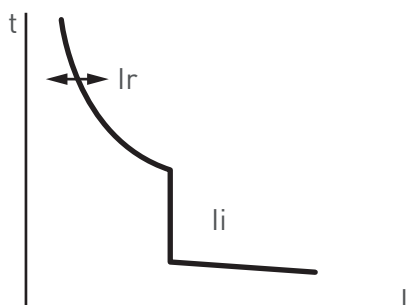

DPX ³ 160				
	THERMAL PROTECTION AGAINST OVERLOADS	MAGNETIC PROTECTION AGAINST SHORT CIRCUITS	RESIDUAL CURRENT PROTECTION	
	I _r	I _i	IΔn	TΔn
Thermal-magnetic	Setting 0,8 or 0,9 or 1 x I _n	Fixed	-	-
Magnetic only	-	Fixed	-	-
Thermal-magnetic with e.l.c.b.	Setting 0,8 or 0,9 or 1 x I _n	Fixed	Setting 0,03 or 0,3 ou 1 or 3 A	Setting 0 or 0,3 or 1 or 3 sec ⁽¹⁾

(1) : The 0.03 A setting must have an undelayed trigger.

■ For DPX³ 160 MCCBs with electronic earth leakage module

	Δt (s)	IΔn (A)			
		0,03	0,3	1	3
	0	✓	✓	✓	✓
	0,3	✗	✓	✓	✓
	1	✗	✓	✓	✓
	3	✗	✓	✓	✓

For a trip threshold setting of IΔn = 0.03 A, the tripping time is automatically set to Δt = 0 s. It is not possible to modify this tripping time as long as the IΔn threshold value is set to 0.03 A. IΔn and Δt are adjustable by the buttons. It is necessary to declare the type of protective device (type A).

■ For DPX³ 160 MS (magnetic only) MCCBs

DPX³ magnetic only MCCBs are derived from the thermal-magnetic version where the thermal release element has been removed.

I _n	Setting the magnetic version
16A	400A
25A	500A
50A	630A
63A	1000A

5 RESET

After a DPX³ MCCB has tripped, the switch handle must be reset to the OFF (O) position before it can close again.

6 RESIDUAL CURRENT FAULT TRIP INDICATOR

A residual current fault is signalled by the visual indicator, which changes state from black to yellow.

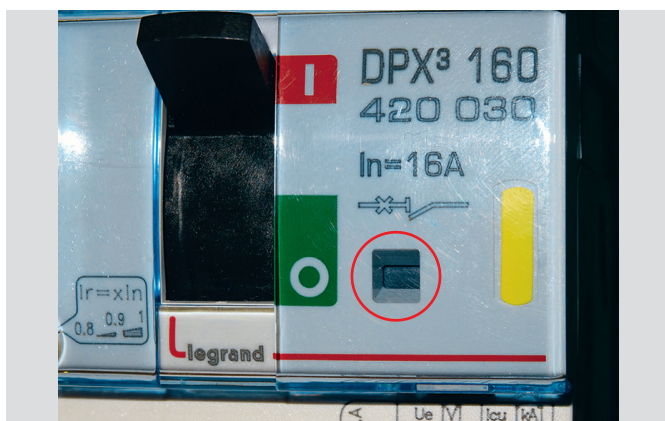

CLOSED (ON).

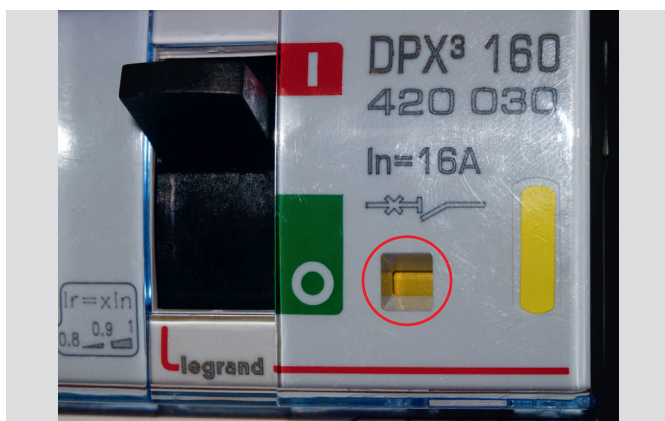

TRIPPED ON RESIDUAL CURRENT FAULT.



The trigger is also recorded in the intervention history accessible from the screen.

7 OPENING THE FRONT PANEL

To open the front panel, simply set the switch handle to the OFF position (O) or trip the DPX³, then unscrew the 2 screws at the top of the panel.

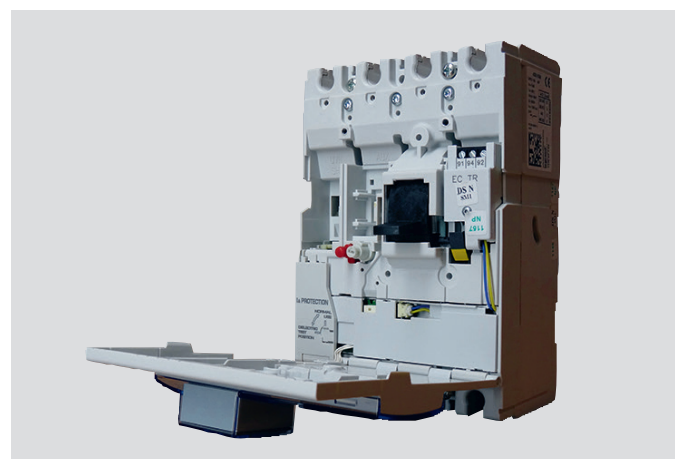
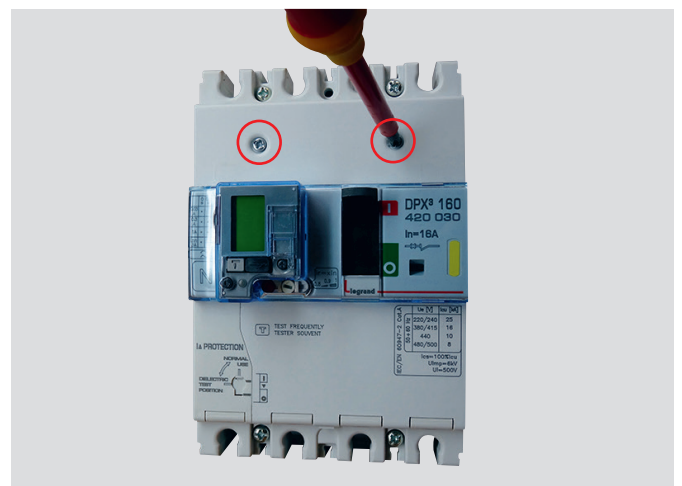

Accessoires électriques DPX³ 160

1 ELECTRICAL ACCESSORIES

CAT.NO	DESCRIPTION
4 210 10	Auxiliary contact for rotary handles
4 210 11	Auxiliary or fault signal contact
4 210 48	Signalling contact plugged-in for plug-in version
Shunt trips	
4 210 12	12 V \sim and =
4 210 13	24 V \sim and =
4 210 14	48 V \sim and =
4 210 15	100-130 V \sim
4 210 16	200-277 V \sim
4 210 17	380-480 V \sim
Undervoltage releases	
4 210 18	12 V \sim and =
4 210 19	24 V \sim and =
4 210 20	48 V \sim and =
4 210 21	110-130 V \sim and 110 V=
4 210 22	200-240 V \sim
4 210 23	277 V \sim
4 210 24	380-415 V \sim
4 210 25	440-480 V \sim
4 210 98	Release for time lag undervoltage release to be equipped with cat.no 0 261 90 (230VAC) or 0 261 91 (400VAC)
Batteries for DPX³	
4 210 82	Set of replacement batteries for circuit breaker
Motor operators	
Moteur 24 to 230 V\sim and =	
4 210 60	Side motor operator
4 210 61	Front motor operator

2 AUXILIARY CONTACT (OC)

■ Insertion

The auxiliary contacts (OC) cat.no 4 210 11 are common to the entire DPX³ range.

They have a dedicated mounting slot (⚠) The auxiliary and fault signal contacts are inserted on different sides of the slot

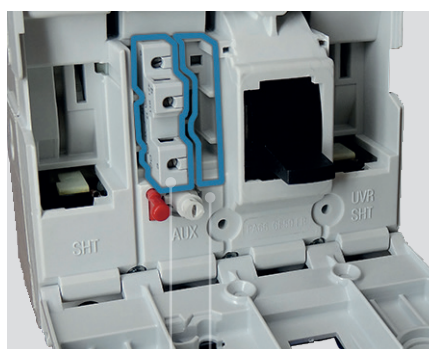
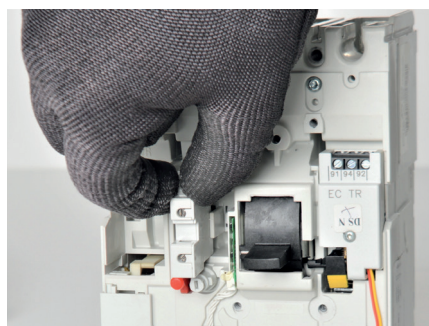

Slot for auxiliary contact

Slot for fault signal contact

■ Connection – Cable outlets

DPX³ MCCBs offer 3 different cable outlet connection options (rear, side or on the top of the device). Several wires can be fed through each outlet type, depending on the model.

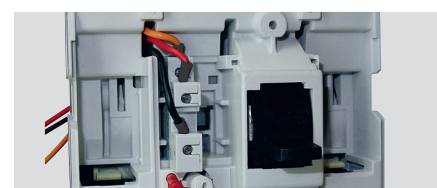

Rear outlet.



Top outlet.



Side outlet.

■ Contact behavior

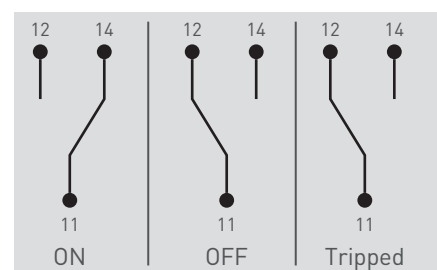

3 FAULT SIGNAL CONTACT (CTR)

■ Insertion

The fault signal contacts (CTR) Cat.no 4 210 11 are common to the entire DPX³ range.

They have a dedicated mounting slot (⚠️ The fault signal contact is inserted on a different side of the slot to the auxiliary contact).

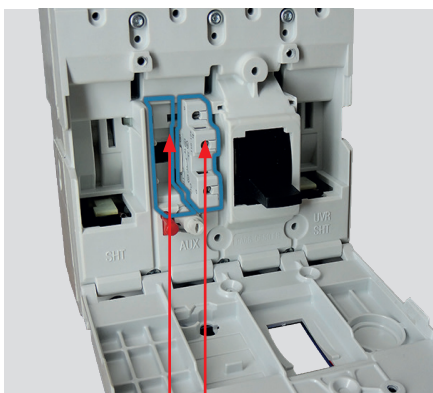
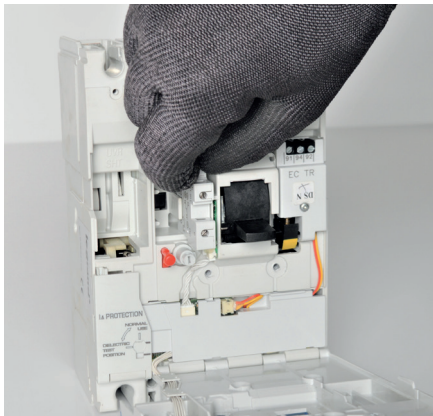

Slot for auxiliary contact

Slot for fault signal contact

■ Connection – Cable outlets

DPX³ MCCBs offer 3 different cable outlet connection options (rear, side or on the top of the device). Several wires can be fed through each outlet type, depending on the model.

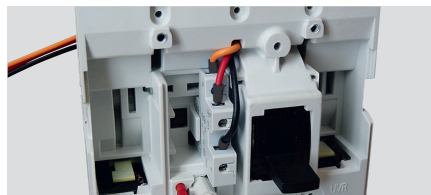

Rear outlet.



Top outlet.



Side outlet.

■ Contact behavior

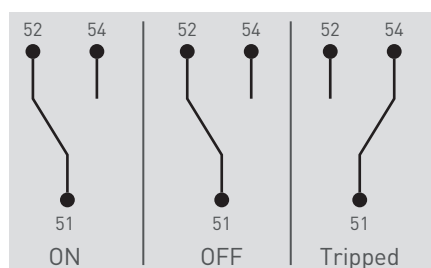

4 SHUNT TRIP (ST), UNDERVOLTAGE RELEASE (UVR)

The shunt trips and undervoltage releases are common to the entire DPX³ 160 and DPX³ 250 range.

There is a wide range of voltages (see page 67 and page 69).

■ Mounting

There is a single dedicated mounting slot on the 3P and 4P with earth leakage module versions. There are two slots on the 4P versions providing the option to use a shunt trip and an undervoltage release (see table opposite).

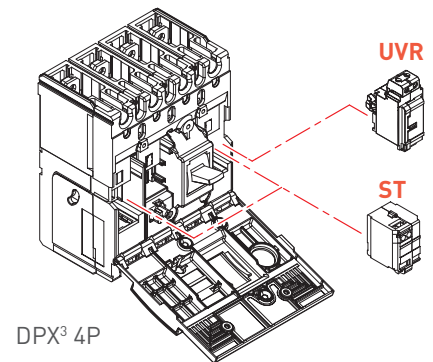

DPX³ 4P

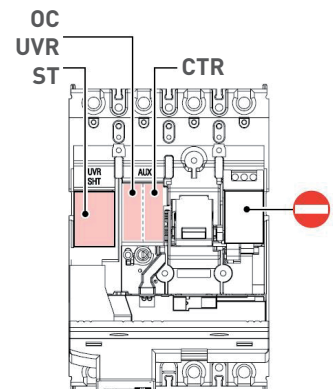

Shunt trip/undervoltage release slot on a DPX³ 4P with earth leakage module

Number of shunt trips/undervoltage releases per DPX³ device:

	DPX ³ 160/250				4P e.l. c.b.
	3P	4P			
Shunt trip (ST)	1	2	1	0	1
Undervoltage release (UVR)		0	1	1	

■ Connection - Cable outlets

DPX³ MCCBs offer 3 cable outlet connection options (rear, side or on the top of the device) just like for the auxiliary contacts.

■ Connection - Terminals

The terminals are connected using a flexible cable with a cross-sectional area of 1.5 mm² (see diagram below).

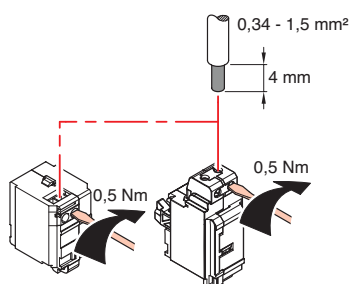

Undervoltage release:

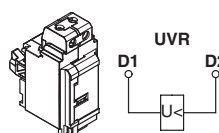

Shunt trip:

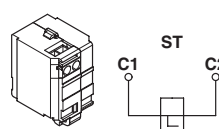

5 FRONT MOTOR OPERATOR (CAT.NO 4 210 61)

A single catalogue number (4 210 61) supports the entire voltage range from 24 V to 230 V DC and AC.

This operator provides access to the connections and settings.

■ Installing the motor



Open and drill 3 x 4 mm holes in the front panel of the circuit breaker as indicated in the installation instructions.



Align the motor operator base unit with the drill holes and fix it in position.

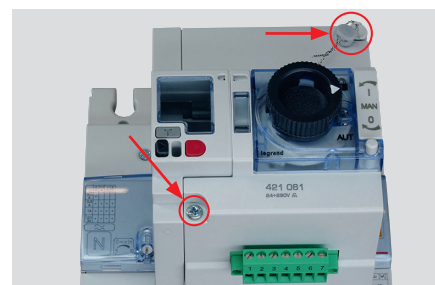

Attach the motor to its base using 2 screws at diagonally opposite corners. A sealable screw cover can be placed over one of these screws.

The wiring terminal block is attached under the motor operator (2 integral screws on the terminal block).

The left-hand side of the motor operator (solid or transparent) is interchangeable depending on the type of circuit breaker.

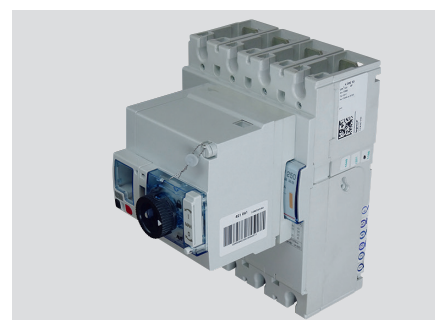

5 FRONT MOTOR OPERATOR (CAT.NO 4 210 61) (CONTINUED)

■ Installing padlocks

Padlocking :

There are 2 ways of padlocking the front motor operator:

- Directly on the motor operator (maximum of 3 x 5 mm diameter padlocks).

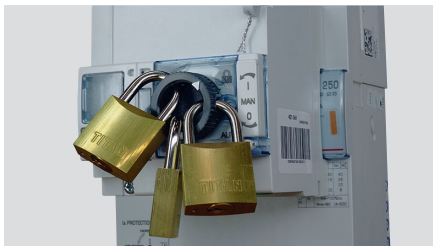

- Using Cat.no 4 210 64 which supports a maximum of 3 x 8 mm diameter padlocks.

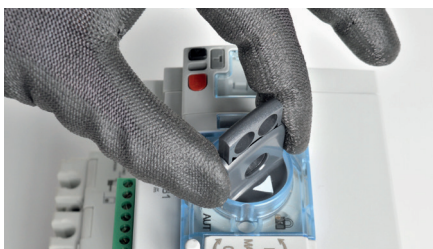

Pull the motor operator handle out to insert the padlocks.



■ Keylocks

Keylocks can be used instead of the motor operator rotary knob.

CAT.NO	DESCRIPTION
4 210 62	Barrel with flat key No. ABA90GEL6149 for front motor operators
4 210 63	Barrel with star key No. HBA90GPS6149 for front motor operators

■ Mounting example (star key)



Remove the rotary knob by unscrewing the 2 screws under the motor operator key.



Attach the key lock in place using the same 2 screws.



Lock it using the key.

6 SIDE MOTOR OPERATOR (CAT.NO 4 210 60)

This is installed on the DPX³ using adaptor Cat.No 4 210 68.

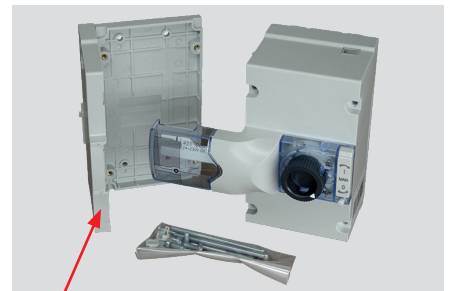

Width adaptor plate (included in cat.no 4 210 60) .

+

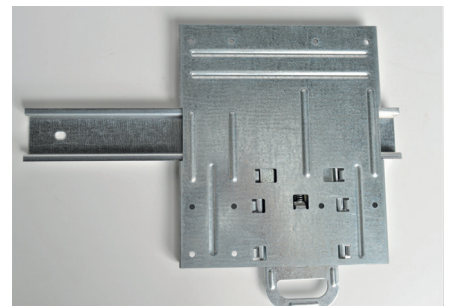

└ rail mounting adaptor Cat.No 4 210 68.

This motor operator (Cat.No 4 210 60) is the same for mounting a DPX³ 160 or a DPX³ 250 MCCB.

■ Installing the motor

This procedure is the same across the DPX³ 160 and 250 range, except for the width adaptor plate that needs to be installed on DPX³ 160 MCCBs.

See the mounting instructions in the DPX³ 250 section on page 44.

Interlocking is not possible with 2 DPX³ MCCBs equipped with side motor operators.

■ Installing padlocks

As with the front motor operator, there are 2 ways of padlocking the side motor operator:

- Directly on the motor operator (maximum of 3 x 5 mm diameter padlocks, see page 39).
- Using Cat.No 4 210 67 which supports a maximum of 3 x 8 mm diameter padlocks.



4 210 67



Pull the motor operator handle out.



Insert the padlocks.

■ Keylocks

Keylocks can be used instead of the motor operator rotary knob.

CAT.NO	DESCRIPTION
4 210 65	Barrel with flat key No. ABA90GEL6149 for side motor operators
4 210 66	Barrel with star key No. HBA90GPS6149 for side motor operators

See the mounting instructions on page 16 (identical for both motor operator types).

7 BATTERIES (CAT.NO 4 210 82)

■ Function

The internal batteries allow the protection unit on electronic DPX³ MCCBs and/or DPX³ MCCBs with earth leakage module to be set in the workshop before installation.

■ Insertion

- Remove the battery holder on the left side of the protection unit using a small flat screwdriver.

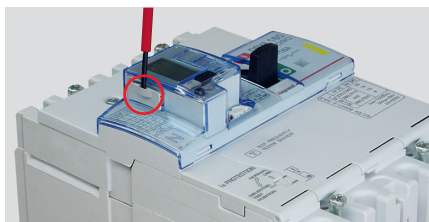

Battery holder

- Insert the 2 batteries into the holder with the «+» facing upwards.



- Replace the holder back in the device.



- Set the protection unit.

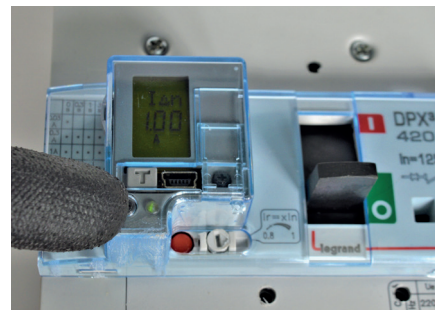

i The protection unit indicates when the batteries need replacing on the front panel. Protection is provided even if the batteries are discharged or removed.

DPX³ 160 mechanical accessories

1 CATALOGUE NUMBERS

CAT.NO	DESCRIPTION
Supply inverters	
	Plate for rail mounting and interlocking 2 DPX ³ MCCBs Used to build a supply inverter with 2 DPX ³ 160, 2 DPX ³ 250 or 1 DPX ³ 160 and 1 DPX ³ 250
4 210 58	DPX ³ supply inverter, fixed version
4 210 59	DPX ³ supply inverter, plug-in version
Rotary handles	
Direct rotary handles (fixed)	
4 210 00	Standard handle for thermal-magnetic DPX ³ without earth leakage module
4 210 01	Standard handle for electronic DPX ³ and DPX ³ with earth leakage module
4 210 02	Handle for emergency use for thermal-magnetic DPX ³ without earth leakage module
4 210 03	Handle for emergency use for electronic DPX ³ and DPX ³ with earth leakage module
4 201 60	Standard handle
4 201 73	Emergency handle
Remote rotary handles	
4 210 04	Standard handle
4 210 05	Emergency handle
4 201 61	Standard handle
4 201 74	Emergency handle
Accessories for locking rotary handles in the OFF position (Fixed)	
4 210 06	Barrel with flat key No. ABA90GEL6149 for direct handles
4 210 07	Barrel with star key No. HBA90GPS6149 for direct handles
4 210 08	Barrel with flat key No. ABA90GEL6149 for remote handles
4 210 09	Barrel with star key No. HBA90GPS6149 for remote handles
4 228 00	Key barrel and Ronis key EL43525 for direct handle
4 228 01	Key barrel and Ronis key EL43363 for direct handle
4 228 02	Key barrel and Ronis key EL43525 for vari-depth handle
4 228 03	Key barrel and Ronis key EL43363 for vari-depth handle
Accessories for locking rotary handles in the ON position	
4 201 64	Key barrel for direct handle
4 201 65	Key barrel and Ronis key EL43525 for direct handle
4 201 66	Key barrel and Ronis key EL43363 for direct handle
4 201 67	Key barrel and Ronis key for remote handle
4 201 68	Key barrel and Ronis key EL43525 for remote handle
4 201 69	Key barrel and Ronis key EL43363 for remote handle

CAT.NO	DESCRIPTION
Locking accessories	
4 210 49	Padlocking accessory for locking in the OFF position
4 210 45	Barrel with flat key No. ABA90GEL6149 for plug-in bases
4 210 46	Barrel with star key No. HBA90GPS6149 for plug-in bases
4 210 47	Padlocking accessory for plug-in bases

2 MOUNTING DPX³ 160 ON DIN RAIL



This allows DPX³ 160 and 250 MCCBs to be attached to the same rail as modular devices.



- Attach the DPX³ to its adaptor. (see cat.nos page 66).



- Clip the assembly onto the rail.

It is possible to align products of different sizes (moulded + modular boxes) on the same rail using height spacer (cat.no 4 052 26) to be positioned on the rail under the modular and to make the row usable:

Spacer Cat.no 4 052 26.



- Cut the spacer to the correct length (if necessary) and clip it onto the rail next to the DPX³.

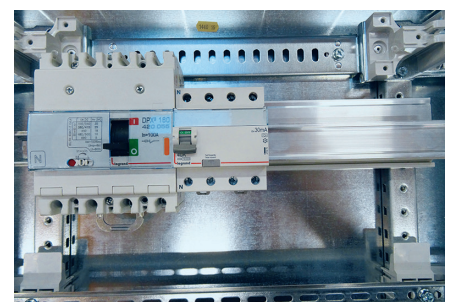

2 FIXING DPX³ 160 ON DIN RAIL (CONTINUED)

■ Fixing screw

- Screw for panel mounting DPX³ MCCBs, Cat.No 4 210 81, length 70 mm, supplied with washer and nut.
- Screw for mounting DPX³ MCCBs on adaptors for 2 rail mounting, Cat.No 4 210 84, length 65.5 mm.

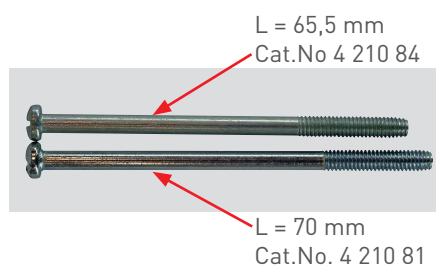

3 PLUG-IN BASE (CAT.NO 4 210 40/41)

■ Front/rear - connecting base

Base for mounting DPX³ 160, 4-pole MCCBs, Cat.No 4 210 41.



■ Preparing the DPX³ 160

Press the device test button.



There are 2 possible mounting solutions using this base: front-connecting or rear-connecting.

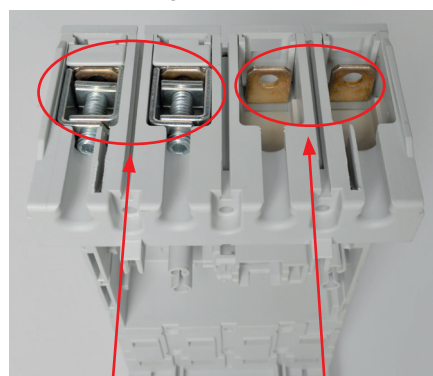

Mounting the terminals for front connection

Mounting the terminals for rear connection

■ Mounting the connections on the circuit breaker

- Position the square nut in the plastic housing then insert the assembly into the circuit breaker.

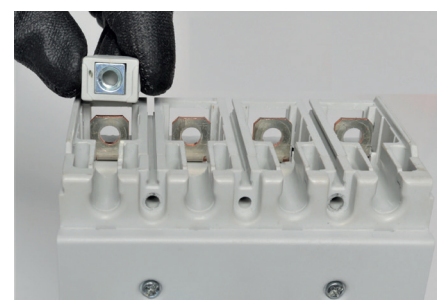

- Tighten using the terminal adaptors provided (angled at 90°), making sure the metal part (labelled D1 in the installation instructions) is positioned between the screw and the terminal adaptor.



**3 PLUG-IN BASE (CAT.NO 4 210 40/41)
(CONITNUED)**

Position the 2 inserts.

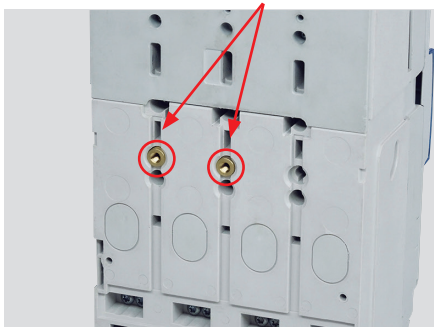

Insert the black U attachment (having prepared it as described in the installation instructions).

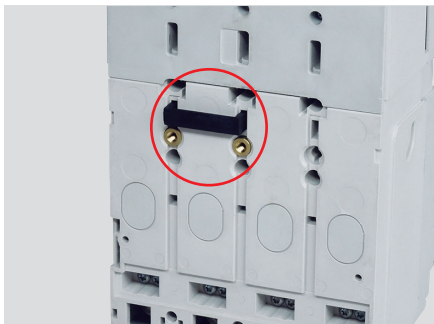

Insert the white plastic hook.

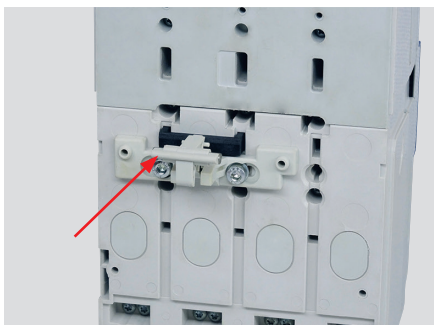

Attach the white plastic hook using the screws provided.

Insert the 4 plastic parts (grips) on the circuit breaker.

On the rear:

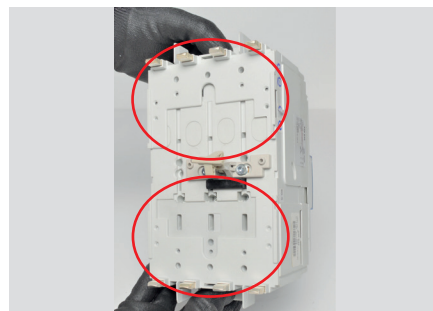

On the front:



- Position and tighten the countersunk head screws provided (2 screws for a 4-pole DPX³ 160, 3 for a 3-pole DPX³ 160 and 4 for a DPX³ 250).



- Position and tighten the metal pins (2 for a 3-pole DPX³, 3 for a DPX³ 160 with earth leakage module and 4 for other models) using washers.

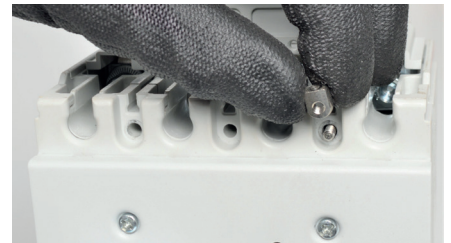

- Position the nut.

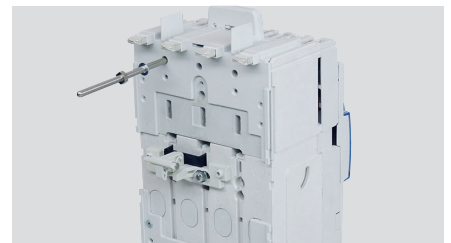

- Screw the metal pin in place.



- Repeat these operations (depending on the model).

i Refer to the installation instructions for mounting and safety guidelines.

3 PLUG-IN BASE (CAT.NO 4 210 40/41) (CONTINUED)

The circuit breaker can now be inserted into the base, with the circuit breaker switch handle in the OFF position. It is fixed in place using the 2 long screws provided.



Open the front panel on the circuit breaker. Press the test button then break off the 2 pre-cut side sections on the front panel.

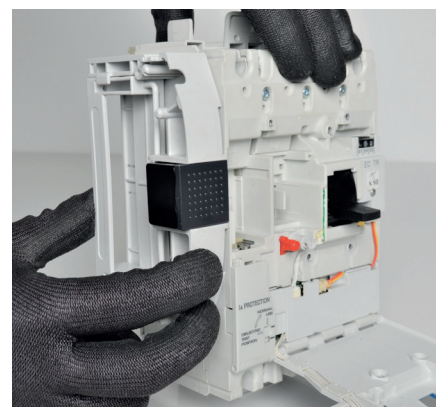
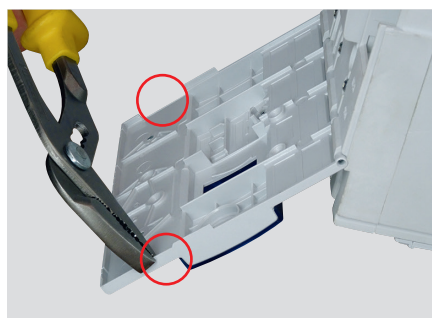

Connect the auxiliaries to the connector using the wires provided, making sure to feed them through the device correctly.



Attach the black plastic insert onto the mounting support using the screw provided and attach the assembly to the circuit breaker.

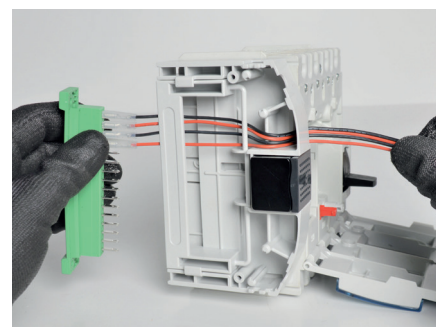
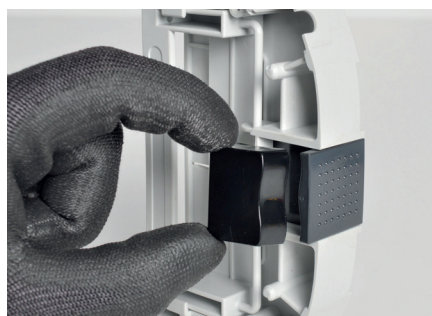

Set of connectors (Cat.No 4 210 44)

This set of connectors is used to connect auxiliary circuits. It can be used across the DPX³ 160/250 range.

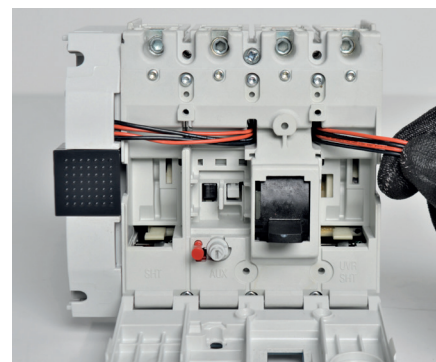
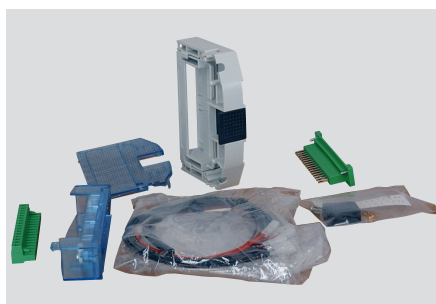

**3 PLUG-IN BASE (CAT.NOS 4 210 40/41)
(CONITNUED)**

■ **Set of connectors
(Cat.no 4 210 44) (continued)**

Attach the connectors using the 2 screws provided.

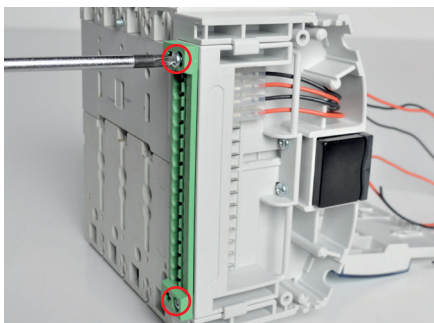

Attach the transparent protective cover using the 2 screws provided.

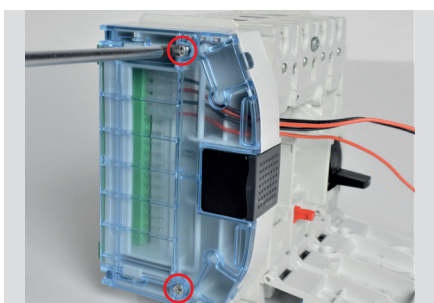

Attach the female connector support to the device using the screw provided.

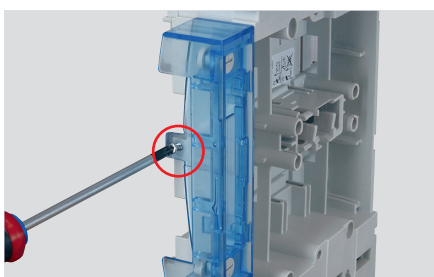

Insert the female connector at the rear of the support and lock it in position by turning each of the screws on the support (1 at the top and 1 at the bottom) a quarter turn.

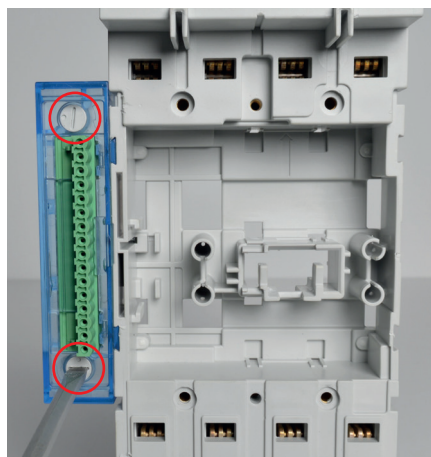

■ **Connecting the front terminals**

Screw terminals for lugs: supplied with the base.

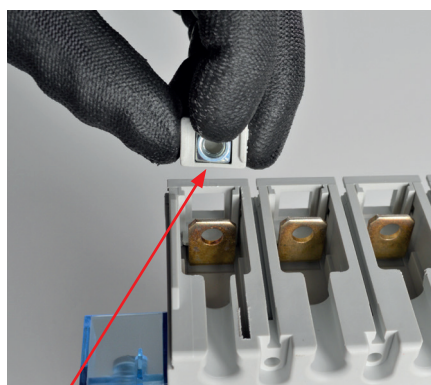

Mounting the terminals for front connection..

Cage terminals for flexible or rigid cables, lugs and bars: use the cage terminals supplied with the DPX³ 160 (to be associated with copper connectors only) or the high capacity cage terminals (to be combined with copper or aluminium connectors) Cat No. 4 210 26 (set of 3 terminals) or 4 210 27 (set of 4 terminals).



Cage terminal supplied with the DPX³

■ **Connecting rear terminals
(Cat.No 4 210 36 → jeu de 3
Cat.No 4 210 37 → jeu de 4)**

The mounting procedure is the same across the DPX³ 160/250 range. Installation kit Cat.No 4 210 76 (for DPX³ 160) or 4 210 77 (for DPX³ 250) is required for installation in a non-XL³ enclosure.

The rear terminals can face in 2 different directions by rotating them 90°.

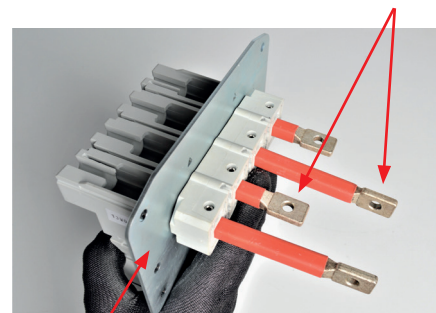

Cat.No 4 210 76

3 PLUG-IN BASE (CAT.NOS 4 210 40/41) (CONTINUED)

■ Keylocks

There are 2 catalogue numbers for keylocks which can be mounted on plug-in bases for both a DPX3 160 and a DPX3 250 MCCB:

- 4 210 45 → Barrel with flat key ;
- 4 210 46 → Barrel with star key ;

Attach the barrel using the screw provided.



Position non verrouillée : la clé ne peut pas être enlevée, le DPX³ peut être monté.



Unlocked position: the key cannot be removed and the DPX³ can be mounted on the base.



■ Padlocking accessory (Cat.No 4 210 47)

There is a single padlocking accessory which is compatible with all DPX³ 160 and 250 plug-in bases.

Insert the padlocking accessory into the base.



Attach the padlocking accessory using the screw provided.



A maximum of 3 padlocks (max. diameter 6 mm) can be used in the locked position.

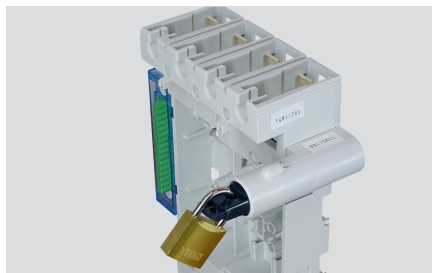

4 DIRECT ROTARY HANDLE

This can be mounted on DPX³ 160 and DPX³ 250 models.

■ Mounting

Example of mounting handle Cat.No 4 210 01 :

- Having drilled 3 holes (4 mm diameter) in the cover as shown in the installation instructions, attach the plastic mounting support using the 3 screws provided.



4 DIRECT ROTARY HANDLE (CONTINUED)

- Attach the handle using the 2 long screws.

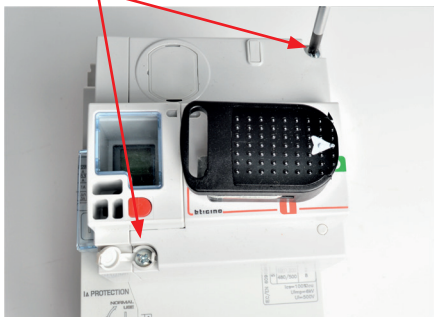

- If there is an electronic display unit-mount the (remote) test and play buttons on the plastic mounting support (with the transparent window).

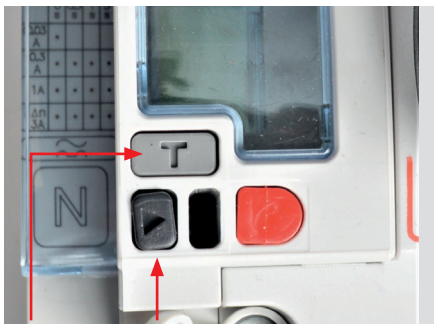

Test button Play button

- Clip the plastic mounting support onto the handle.



■ Keylocks in ON position

These can be mounted on DPX³ 160 and DPX³ 250 models.

Exemple de montage avec la réf. 4 210 06 (clé plate) :

- Example of mounting with Cat.No 4 210 06 (flat key):



- Insert the barrel into the free slot.



- Insert the spring and the black plastic, insert as shown in the installation instructions.

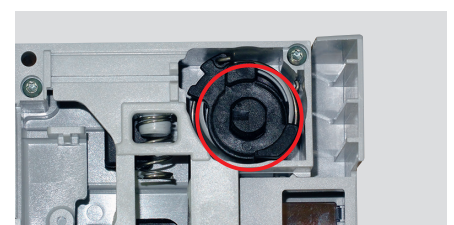

- Insert the slotted metal insert.



- Tighten the slotted metal insert using the key provided.

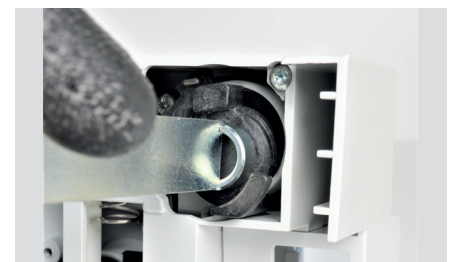

4 DIRECT ROTARY HANDLE (CONTINUED)

The key can only be removed only if the handle (and the DPX³) are in the OFF position.



Padlocking

No specific accessory is required; one or more padlocks (3 maximum) (5 mm diameter min. and 8 mm max.) can be attached directly to the handle by pulling out the metal tab.



■ Auxiliary contacts 2NF - 2NO for rotary handle



This accessory cannot be mounted on the controls Cat.Nos 4 201 60/73.

These are compatible with DPX³ 160 and DPX³ 250 models.



2 positions are possible:

Position 1: Green connector output on the side, top right :

- Break off the connector output slot (on the handle) using a pair of pliers.

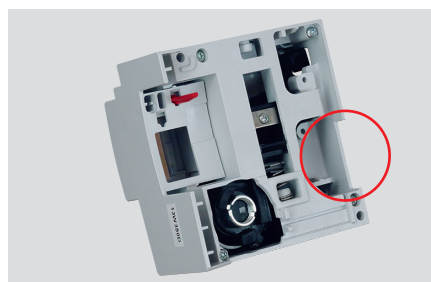

- Position and attach the 2 contacts (1 screw in each) and mount the green connector on the side.

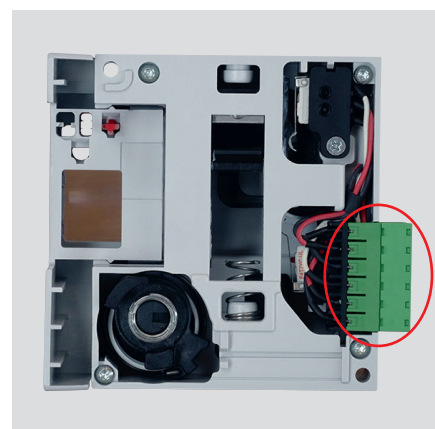
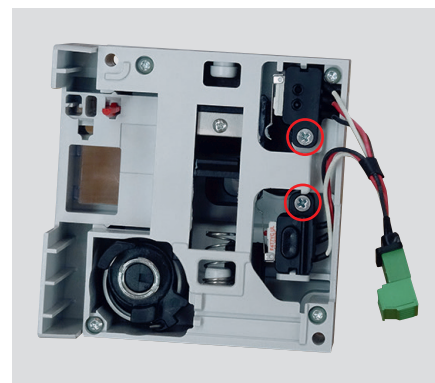

4 COMMANDE ROTATIVE DIRECTE (SUITE)

■ **Auxiliary contacts (continued)**

Position 2: Connector output at the bottom:

- Break off the connector output slot (on the handle plastic mounting support) using a pair of pliers.

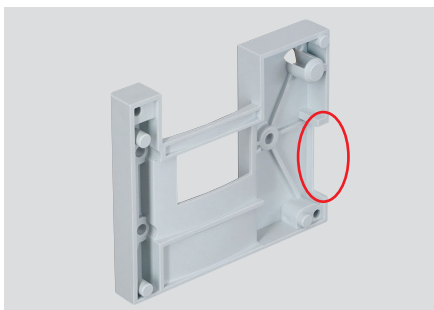

- Position and attach the 2 contacts, (1 screw in each) and mount the green connector at the bottom.

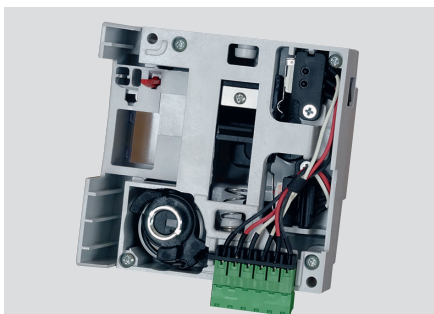

! Both 2 contacts have wires of different lengths. It is possible to place these contacts in a single slot in this position.

■ **Functions available**

! The 2 functions below are not possible on controls cat.nos 4 201 60/73.

1 - Circuit breaker inoperative without faceplate

Remove the plastic tab to enable this function.



It is then impossible to set the circuit breaker to the «ON» position without a faceplate.



2 - Faceplate removal disabled with circuit breaker in ON position

Remove the plastic tab to enable this function.



When the circuit breaker is in the «ON» position, the pin prevents removal of the faceplate.



5 REMOTE ROTARY HANDLE

2 catalogue numbers are compatible with DPX³ 160 and 250 models:

- Standard fixed handle Cat.No 4 210 04 (black operator)
- Fixed handle for emergency use Cat.No 4 210 05 (red operator)
- Standard handle Cat.No 4 201 61 (black operator) - IP 54
- Handle for emergency use Cat.No 4 201 74 (red operator) - IP 54

■ **Mounting**

The remote rotary handle is mounted on the DPX³ in much the same way as the direct rotary handle or the front motor operator (see previous sections).

The difference lies in the fact that the operator is installed on a faceplate or door. Example of mounting a remote rotary handle and its keylock:

! Correctly identify the IP degree and distance DPX³/plastron beforehand: different mounting.

Example of mounting a remote rotary handle and its keylock:

- Drill holes in the door or faceplate using the sticker provided.

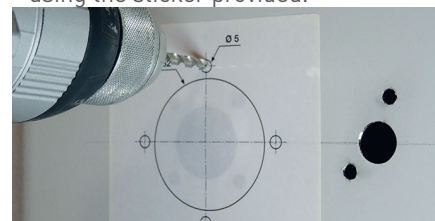

- Assemble the handle operator mounting support on the locking system.

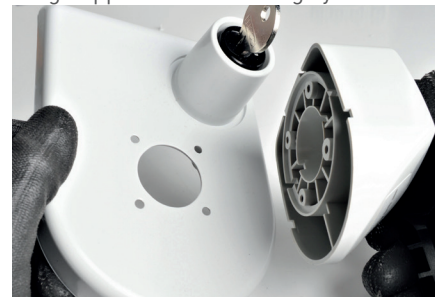

- Secure the assembly using the screws provided.

5 REMOTE ROTARY HANDLE (CONTINUED)



- Attach the locking system to the door/faceplate with the circuit breaker in the ON position.



Adapt the shaft length according to the distance between the door/faceplate and the circuit breaker (refer to the installation instructions for the remote rotary handle).

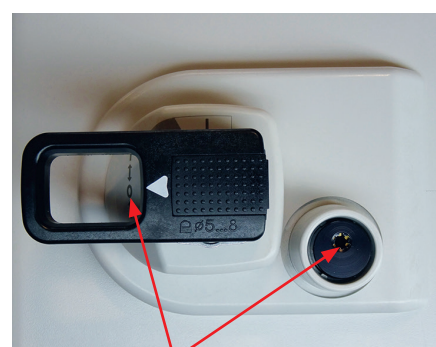

The key can only be removed if the handle (and the DPX³) are in the «OFF» position .

■ Padlocking

No specific accessory is required; one or more padlocks (3 maximum) (5 mm diameter min. and 8 mm max.) can be attached directly to the handle by pulling out the metal tab.



- Position the padlocking accessory.

■ Keylocks in OFF position

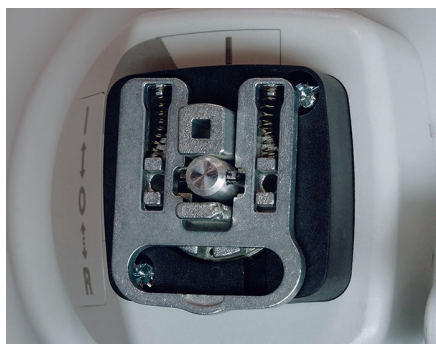

- Secure the handle operator using the 2 screws provided.

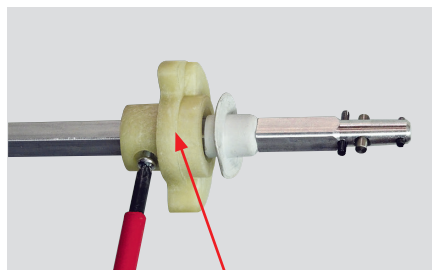

Insert the part shown in the photo above on the shaft to adapt it for locking purposes.

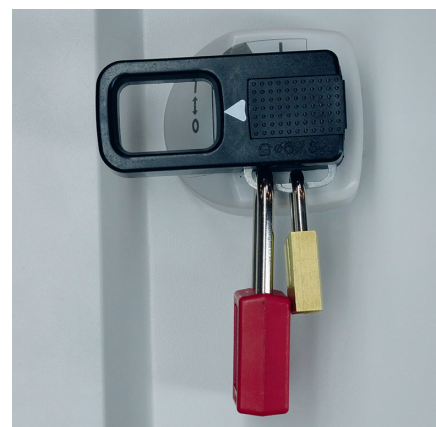

■ Auxiliary contacts

Same as for direct rotary handle (see page 23).

5 REMOTE ROTARY HANDLE (CONTINUED)

■ Vari-depth function

This function is only available on vari-depth remote rotary handles Cat.Nos 4 201 61/74.

! The use of this function is authorized only to previously authorized persons.

It allows the rotary handle to be unlocked without opening the DPX³ circuit. This allows the door to open without interrupting the circuit associated with the control. This makes maintenance and troubleshooting easier.

Inserting a Ø 2mm tool to open the door with the DPX³ in the "ON" position:

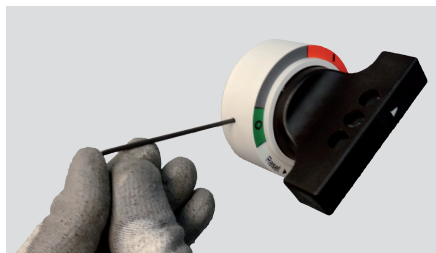

! In the XL³ range, the vari-depth remote rotary controls Cat.No 4 201 61/74 can only be mounted in an XL³ 4000 enclosure equipped with a curved metal door. For any other type of enclosure, mounting is possible if the distance between the plate (or rail) and the faceplate (or door) is ≥ 174 mm.

6 TERMINAL SHIELD CAT.NOS 4 210 50/51/54/55

■ Mounting

For rear connection terminals :

- Insert all the plastic covers on the terminal shields.

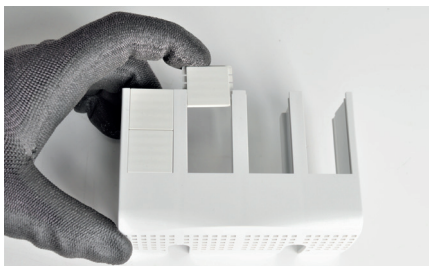

- Secure both terminal shields on the DPX³ using the retainer accessories (2 for each terminal shield).

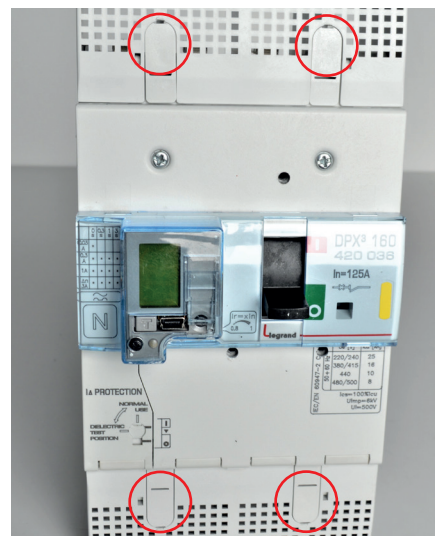

For front connection terminals :

These are installed in the same way as for the rear terminals. These terminal shields are larger than those for the rear terminals (for ease of connection).

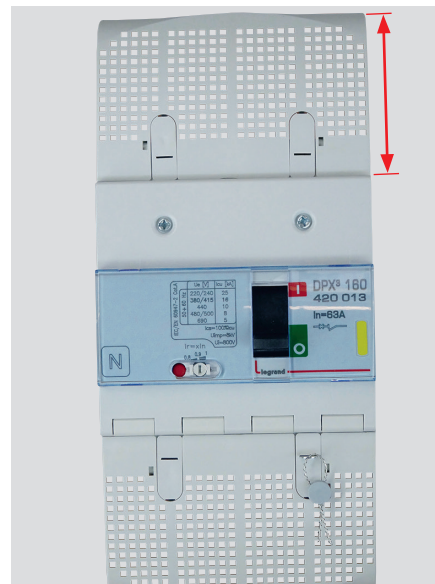

6 TERMINAL SHIELDS CAT.NOS 4 210 50/51/54/55 (CONTINUED)

■ Sealing

- Before inserting the retainer accessory, attach the metal tab (in the shape of a bracket) using the screw provided.

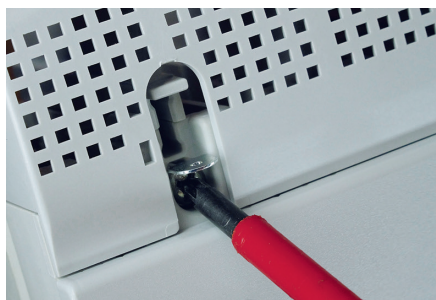

- Insert the retainer accessory, then feed the seal through the hole in the bracket.



The seal is available as a spare part Cat.No 4 210 95 (see page 67).

7 SWITCH HANDLE PADLOCKING ACCESSORY (CAT.NO 4 210 49)

■ Photo



■ Mounting

- Set the circuit breaker to the position → «OFF»



- Insert the padlocking accessory with the metal parts onto the circuit breaker switch handle.



- Clip the second part of the accessory onto the first.



Padlocking is then possible using a maximum of 3 padlocks (min. diameter 5 mm and max. diameter 8 mm).



8 SUPPLY INVERTER

■ Catalogue numbers

- 4 210 58 : DPX³ supply inverter, fixed version.
- 4 210 59 : DPX³, supply inverter, plug-in version.
- Fixed version.



- Plug-in version.



■ Principle

The purpose is to be able to use 2 DPX³ together and make sure that it is not possible for both devices to be in the ON position at the same time.

Advantages of the system :

- Easily implemented
- Compact
- No adjustment necessary
- Rail mounting enables installation in small cabinets.

■ Mounting

Fixed version with a DPX³ 160 and a DPX³ 250.

- Attach the inverter system (central part) to the plate provided using 4 long screws.

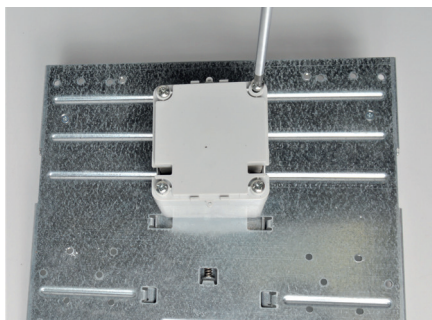
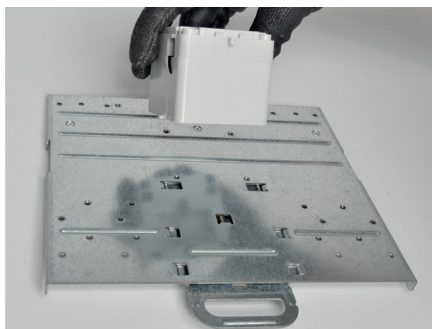

- Press the trip (test) button or set the circuit breaker to the OFF position (0) and insert the metal dowel pin into the hole on the side of the circuit breaker.



- Dowel pin without shoulder for a DPX³ 250.



- Dowel a pin with shoulder for a DPX³ 160.

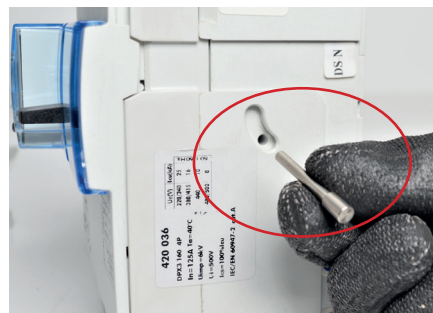

8 SUPPLY INVERTER (CONTINUED)

- Insert the circuit breaker equipped with dowel pin into the central part of the inverter⁽¹⁾.

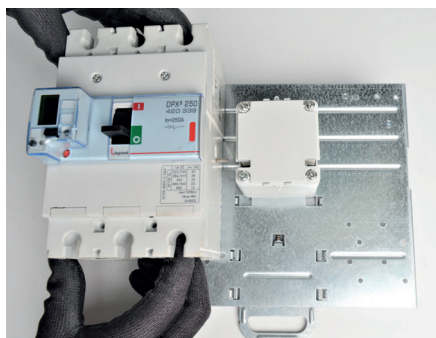

- Attach the circuit breaker to the panel (screw included with product)⁽¹⁾.

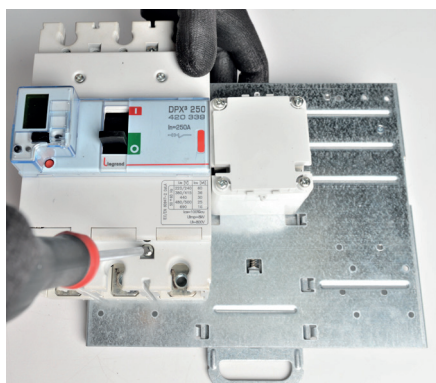

(1) Repeat these actions for the second circuit breaker.

- Place the plastic cover supplied with the inverter over the inverter.

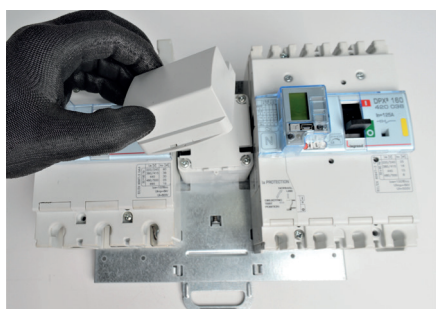

It is possible to place 2 seals on the inverter.



■ Plug-in version



This additional part is required to adapt to the height of plug-in bases; the rest of the mounting procedure is the same as for the fixed version.

■ Integration in XL³ enclosures

The installation of a transfer switch is possible in our XL³ 160/400/800/400/4000/6300 and XL³ S 160/630/4000 cabinets.

DPX³ 160 connections

1 HIGH CAPACITY CAGE TERMINALS CAT.NOS 4 210 26 (SET OF 3 TERMINALS) AND 4 210 27 (SET OF 4 TERMINALS)

■ Photo (4 210 27)

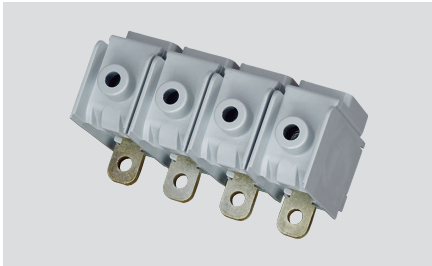

■ Connection capacity

- Flexible cable 35 mm² to 120 mm² (example below with 50 mm² cable).



- Rigid cable 35 mm² to 150 mm² (example below with 150 mm² cable).

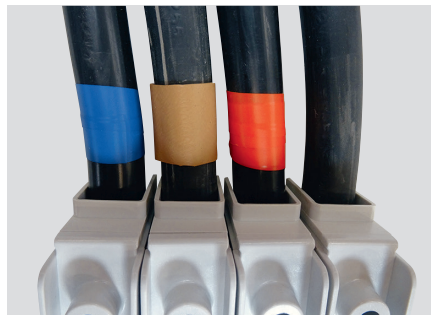

■ Mounting

- Place the square nut in the plastic housing and insert the assembly behind the connection terminals on the DPX³.

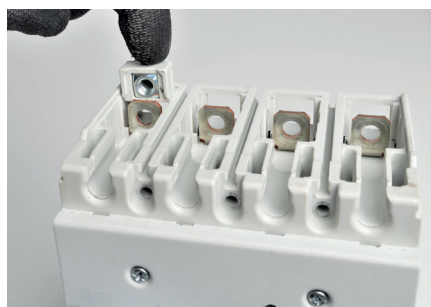

- Place the high capacity cage terminals in front of the DPX³ connection terminals and attach them using the screws provided (Tightening torque 10 N.m).



i High capacity cage terminals are suitable for use with copper and aluminium cables. They can be installed upstream and/or downstream.

2 CAGE TERMINALS CAT.NOS 4 210 93 (SET OF 3) & 4 210 94 (SET OF 4)



Accessories supplied with DPX³ 160.

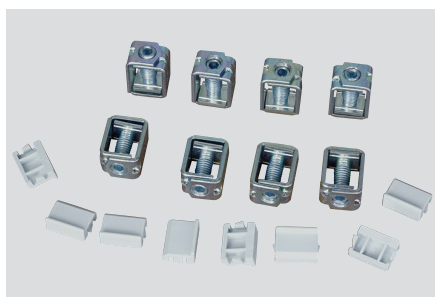

■ Connection capacity :

- Rigid cable 1,5 mm² to 95 mm²
- Flexible cable 1,5 mm² to 70 mm²
- Lug or bar width 14 mm max.

■ Mounting

Loosen the cage terminal slightly so as to be able to insert it into the DPX³ connection terminal.



Clip the plastic insert behind the connection terminal.



Cage terminals Cat.No 4 210 93 and 4 210 94 are suitable for use copper cables only (tightening torque of the conductor in the terminal: 8 Nm).

■ Terminal shield

Cat.Nos 4 210 54 (3-pole) or 4 210 55 (4-pole) are used for front connection terminals.



3 CAGE TERMINALS FOR LUGS CAT.NOS 4 210 28 (SET OF 3 TERMINALS) & 4 210 29 (SET OF 4 TERMINALS)

■ Photo Cat.No 4 210 29



■ **Connection capacity**

- Max. width : 19,5 mm
- Min. hole diameter : 6 mm
- Max. depth : 6,5 mm.

■ **Mounting**

- Place the square nut on the plastic housing.



- Insert the assembly behind the DPX³ connection terminals.



- Attach the lug using the screw provided (Tightening torque 7 N.m).



■ **Terminal shield**

Cat.Nos 4 210 54 (3-pole) or 4 210 55 (4-pole) are used for front connection terminals.

Photo Cat.No 4 210 55



4 CABLE SPREADERS CAT.NOS 4 210 32 (3-POLE) & 4 210 33 (4-POLE)

■ **Photo**
Cat.No 4 210 33



■ **Connection capacity**

- Max. width of bar or lug: 20 mm
- Hole diameter : 8 mm.



The spreaders can be installed upstream and/or downstream.

■ **Mounting**

Insert the spreader in the cage terminal making sure to comply with the mounting direction indicated in the installation instructions and tighten accordingly (Tightening torque 10 Nm).

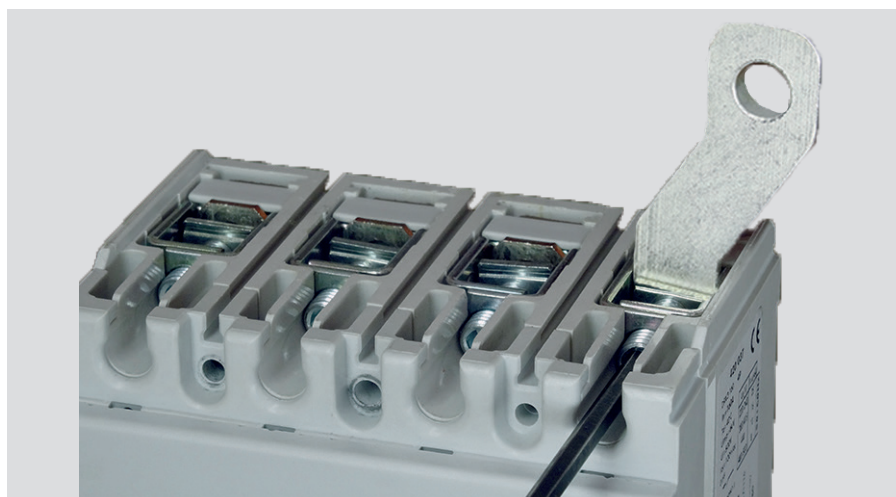

Terminal shields cannot be used with cable spreaders Cat.Nos 4 210 32 & 4 210 33.

DPX³ 160

DPX³ 160 connections

5 REAR TERMINALS CAT.NOS 4 210 36 (SET OF 3) & 4 210 37 (SET OF 4)

■ Photo Cat.No 4 210 37



■ Connection capacity

- Length : 21 mm
- Width : 14 mm
- Hole diameter : 6,3 mm
- Depth : 4,5 mm.

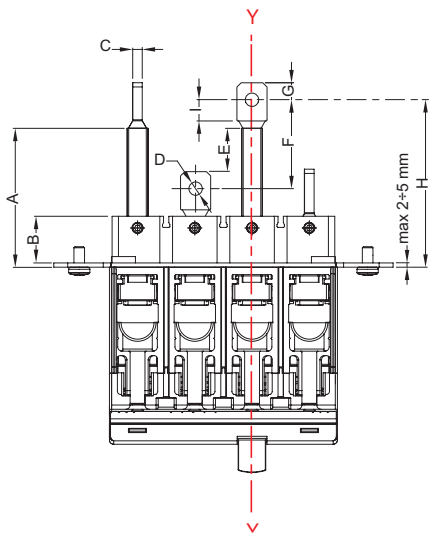

	A	B	C	D	E	F	G	H	I
DPX ³ 160	65,5	22	4,5	6,3	19,5	44	11	79	10
250	65,5	22	6	8,4	15,5	44	15	79	10

■ Mounting

- Insert the plastic inserts behind the DPX³ connection terminals making sure they are mounted in the correct direction.



i The rear terminals can be installed upstream and/or downstream.

- Attach the rear terminals using the screws provided making sure they are positioned according to their length (Tightening torque of the rear terminals on the DPX³ : 10 Nm).

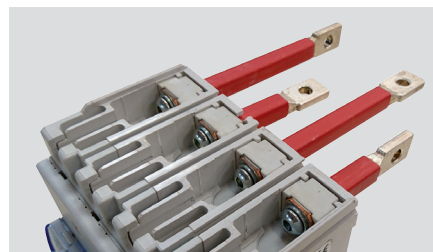

Rear terminals can be rotated 90° to face in 2 different directions.

5 REAR TERMINALS CAT.NOS 4 210 36 (SET OF 3) & 4 210 37 (SET OF 4) (CONTINUED)

■ Terminal shields

Cat.Nos 4 210 50 (3-pole) or 4 210 51 (4-pole) are used for rear connection terminals.

- Insert the blanking plates (supplied with the rear terminals).

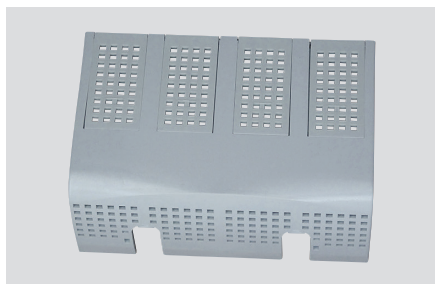
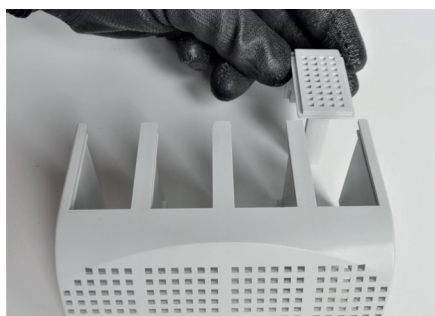

- Mount the terminal shield on the DPX³ then insert the retainer accessories.



Retainer accessories.

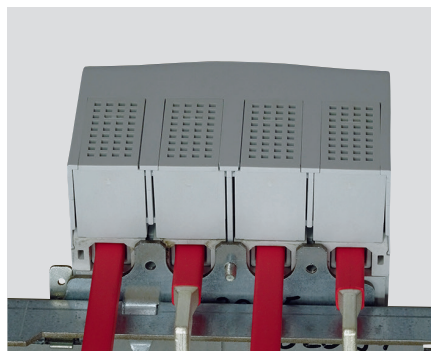

6 INSULATION SHIELD CAT.NO 4 210 70 (SET OF 36)

■ 2 insulation shields are required (for the upstream device) for a DPX³ 3-pole MCCB and 3 are required for a DPX³ 4-pole MCCB (for upstream or downstream)

Example of mounting on a DPX³ 160 4-pole device:

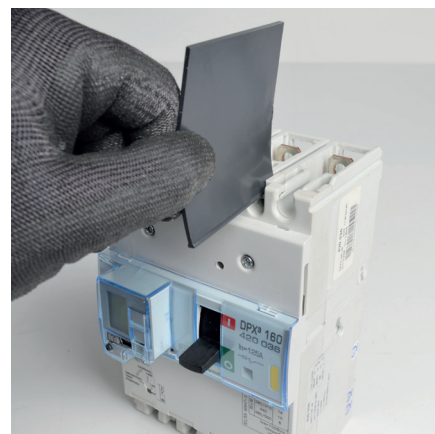

DPX³ 250

Product description

1 CIRCUIT BREAKER FRONT PANEL

■ TM (thermal-magnetic)

Ex. : Cat.No 4 202 15 (In = 100 A).

Test button

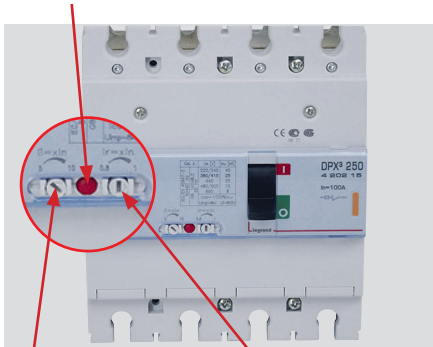

Magnetic setting (Ii) Thermal setting(Ir)

■ TM with electronic earth leakage module

Ex. : Cat No 4 202 28 (In = 200 A).

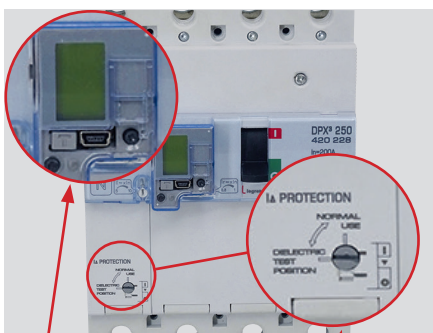

Earth leakage module window

Dielectric disconnection

■ Electronic and electronic with measurement

Ex. : Cat.No 4 203 05 (In = 100 A).



■ Electronic with earth leakage module and electronic with earth leakage module and measurement

Ex. : Cat.No 4 204 22 (In = 40 A).



■ MS (magnetic only)

Ex. : Cat.No 4 207 22 (In = 100 A).



2 TRIP-FREE SWITCH FRONT PANEL



The switch handles on the trip-free switches are grey to differentiate them from the circuit breakers, which have black handles.

3 POSITION OF SWITCH HANDLE (ON - TRIPPED - OFF)



Closed (ON).



Tripped.



Open (OFF).

4 RESIDUAL CURRENT TRIP INDICATOR

A residual current fault is signalled by the visual indicator, which changes state from black to yellow :



Closed (ON)



Tripped (Residual current fault)



The trigger is also recorded in the intervention history accessible from the screen.

5 RESET

After tripping, the circuit breaker must be reset by setting it to «OFF» position (O).

6 OUVERTURE FACE AVANT

The front panel is opened in the same way as for DPX³ 160 MCCBs. Simply remove the 2 screws at the top of the panel and tilt it forwards (after putting the product in the «OFF» or «Tripped» position).

This allows you to insert electrical accessories (auxiliary contact, fault contact and releases).



7 SETTINGS AT 40° C & 50° C

DPX ³ 250								
	THERMAL PROTECTION AGAINST OVERLOADS		MAGNETIC PROTECTION AGAINST SHORT-CIRCUITS		PROTECTION AGAINST EARTH FAULTS		RESIDUAL CURRENT PROTECTION	
Thermal magnetic	Ir Setting 0,8 or 1 xln	-	Ii Setting 5 or 10 xln	-	-	-	-	-
Thermal magnetic with e.l.c.b.	Ir Setting 0,8 or 1 xln	-	Ii Setting 5 or 10 xln	-	-	-	Setting 0,03 or 0,3 or 1 or 3 A	Setting 0 or 0,3 or 1 or 3 sec
Electronic	Ir Setting (by steps of 1 A) 0,4 to 1 xln	tr Setting (memory ON or memory OFF) 3 or 5 or 10 or 15 sec.	Isd Setting 1,5 or 2 or 2,5 or 3 or 4 or 5 or 6 or 7 or 8 or 9 or 10 xlr	tsd Setting (I ² t=k or not) 0 or 0,1 or 0,2 or 0,3 or 0,4 or 0,5 sec.	-	-	-	-
Electronic with e.l.c.b.	Ir Setting (by steps of 1 A) 0,4 to 1 xln	tr Setting (memory ON or memory OFF) 3 or 5 or 10 or 15 sec.	Isd Setting 1,5 or 2 or 2,5 or 3 or 4 or 5 or 6 or 7 or 8 or 9 or 10 xlr	tsd Setting (I ² t=k or not) 0 or 0,1 or 0,2 or 0,3 or 0,4 or 0,5 sec.	-	-	Setting 0,03 or 0,3 or 1 or 3 A	Setting 0 or 0,3 or 1 or 3 A sec
Electronique Sg	Ir Setting (by steps of 1 A) 0,4 to 1 xln	tr Setting (memory ON or memory OFF) 3 or 5 or 10 or 15 sec.	Isd Setting 1,5 or 2 or 2,5 or 3 or 4 or 5 or 6 or 7 or 8 or 9 or 10 xlr	tsd Setting (I ² t=k or not) 0 or 0,1 or 0,2 or 0,3 or 0,4 or 0,5 sec.	Ig Setting OFF or 0,2 or 0,3 or 0,4 or 0,5 or 0,6 or 0,7 or 0,8 or 1 xln	tg Setting 0,1 or 0,2 or 0,3 or 0,4 or 0,5 or 1 sec	-	-
Magnetic only	-	-	Isd Setting 800 A to 2500 A	-	-	-	-	-
AB	Ir Setting 60 or 70 or 80 or 90 or 100 or 110 or 120 or 130 A 140 or 150 or 160 or 170 or 180 or 190 or 200 or 220 or 240 A	tr Setting (memory ON or memory OFF) 3 or 5 or 10 or 15 sec.	Isd fixed 600 A	tsd fixed 0 sec.	-	-	-	-
AB with e.l.c.b.	Ir Setting 60 or 70 or 80 or 90 or 100 or 110 or 120 or 130 A 140 or 150 or 160 or 170 or 180 or 190 or 200 or 220 or 240 A	tr Setting (memory ON or memory OFF) 3 or 5 or 10 or 15 sec.	Isd fixed 600 A	tsd fixed 0 sec.	-	-	Setting 0,03 or 0,3 or 1 or 3 A	Setting 0 or 0,3 or 1 or 3 sec

8 LCD SCREEN DISPLAY

Several parameters can be accessed on the screen of each circuit breaker.
The parameters available for each type of circuit breaker are shown in the table below.

	THERMAL MAGNETIC (TM)	TM WITH E.L.C.B.	ELECTRONIC	ELECTRONIC WITH E.L.C.B.	ELECTRONIC + MEASUREMENT	ELECTRONIC E.L.C.B. + MEASUREMENT
Ir	-	-	✓	✓	✓	✓
IΔn	-	✓	-	✓	-	✓
tr	-	-	✓	✓	✓	✓
I _{sd}	-	-	✓	✓	✓	✓
t _{sd}	-	-	✓	✓	✓	✓
N	-	-	✓	✓	✓	✓
Δt	-	✓	-	✓	-	✓
sel	-	-	✓	✓	✓	✓
I1	-	-	✓	✓	✓	✓
I2	-	-	✓	✓	✓	✓
I3	-	-	✓	✓	✓	✓
In	-	-	✓	✓	✓	✓
I _g	-	-	✓			
t _g	-	-	✓			
IΔ	-	✓	-	✓	-	✓
V1N/V2N/V3N	-	-	-	-	✓	✓
Fréquence (Hz)	-	-	-	-	✓	✓
P _{tot}	-	-	-	-	✓	✓
Q _{tot}	-	-	-	-	✓	✓
PF	-	-	-	-	✓	✓
Ep↓	-	-	-	-	✓	✓
Ep↑	-	-	-	-	✓	✓
Eq↓	-	-	-	-	✓	✓
Eq↑	-	-	-	-	✓	✓
THDV1/V2/V3	-	-	-	-	✓	✓
THDI1/2/3/N	-	-	-	-	✓	✓
MEM	-	✓	✓	✓	✓	✓

LEXIQUE

Ir : Current setting (A)
IΔn : Earth leakage module threshold (mA)
tr : Time delay on current setting (s)
I_{sd} : Short delay current (magnetic) (A)
t_{sd} : Short delay time delay (magnetic) (s)
N : Neutral value (Off / 50 % / 100 % / 200%)
Δt : Time variation (s)
Sel : Sélectivity (High/Low)
I1 : Instantaneous value of phase 1 (A)
I2 : Instantaneous value of phase 2 (A)
I3 : Instantaneous value of phase 3 (A)
In : Instantaneous value of Neutral (A)
I_g : Ground fault intensity
t_g : Ground fault time
IΔ : Inter-phase current threshold (A)

V1N/V2N/V3N : Phase-to-neutral voltages (V)
Fréquence (Hz)
P_{tot} : Active power (KW)
Q_{tot} : Reactive power (KVar)
PF : Power factor
Ep↓ : Active energy consumed meter (KWh)
Ep↑ : Active energy restored meter (KWh)
Eq↓ : Reactive energy consumed meter (KVARh)
Eq↑ : Reactive energy restored meter (KVARh)
THDV1/V2/V3 : Total harmonic distortion (phase-to-phase voltages) as a %
THDI1/2/3/N : Total harmonic distortion (current) as a %
MEM : Measured trip value

9 QUELQUES EXEMPLES DE LECTURE



Thermal current setting.



Current setting and earth leakage module threshold.



Time delay on current setting.



Short delay current (magnetic).



See details of the Power Control Station (PCS) software pages 52/53/54.

DPX³ 250 electrical accessories

1 LIST OF CATALOGUE NUMBERS

CAT.NOS	DESCRIPTION
4 210 10	Auxiliary contact for rotary handles
4 210 11	Contact auxiliaire ou signal défaut
4 210 48	Contact disjoncteur inséré pour version extractible
Shunt trip	
4 210 12	12 V \sim and =
4 210 13	24 V \sim and =
4 210 14	48 V \sim and =
4 210 15	100-130 V \sim
4 210 16	200-277 V \sim
4 210 17	380-480 V \sim
Undervoltage releases	
4 210 18	12 V \sim and =
4 210 19	24 V \sim and =
4 210 20	48 V \sim and =
4 210 21	110-130 V \sim and 110 V=
4 210 22	200-240 V \sim
4 210 23	277 V \sim
4 210 24	380-415 V \sim
4 210 25	440-480 V \sim
4 210 98	Release for time lag undervoltage release to be equipped with cat. no 0 261 90 (230VAC) or 0 261 91 (400VAC)
Batteries for DPX³	
4 210 82	Set of replacement batteries for a circuit breaker
Motor operators	
Motor 24 to 230 V\sim and =	
4 210 60	Side motor operator
4 210 61	Front motor operator

2 AUXILIARY CONTACT (OC)

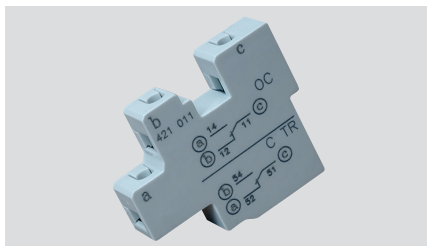

■ Mise en place

The auxiliary contacts (OC) Cat.no 4 210 11 are common to the entire DPX³ range. They have dedicated mounting slot ⚠ The auxiliary and fault signal contacts are inserted on different sides of the slot.

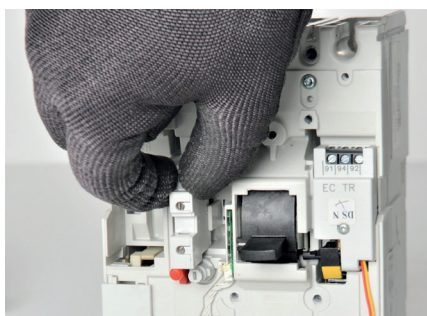

The auxiliary contact block can only be inserted in the left hand side of the dedicated contacts slot.

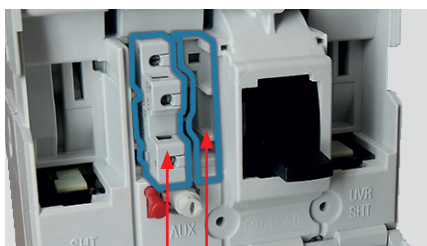

Slot for auxiliary contact | Slot for fault signal contact

Connection -Cable outlets

DPX³ MCCBs offer 3 different cable outlet connection options (rear, side or on the top of the device). Several wires can be fed through each outlet type, depending on the model (3P or 4P).

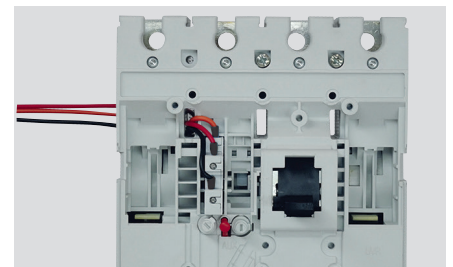

Rear outlet



Side outlet

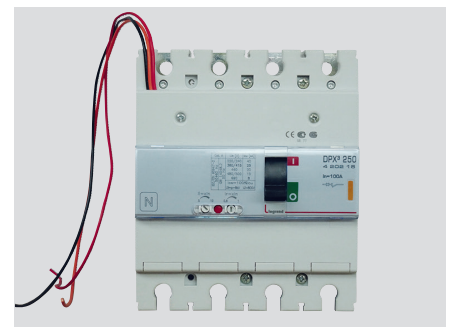

Top outlet

■ Contact behavior

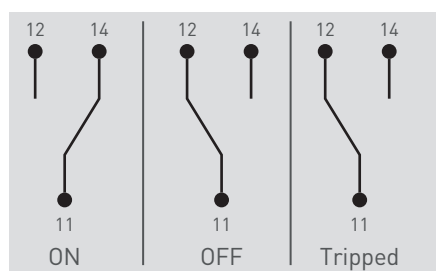

3 FAULT SIGNAL CONTACT (CTR)

The catalogue number for the fault signal contact is the same as for the auxiliary contact (4 210 11).

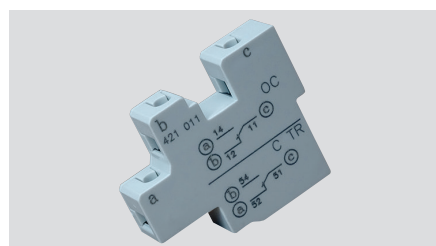

■ Insertion :

The fault signal contact is inserted to the right of the auxiliary contact (⚠). Different side of the slot to the auxiliary contact → OC).

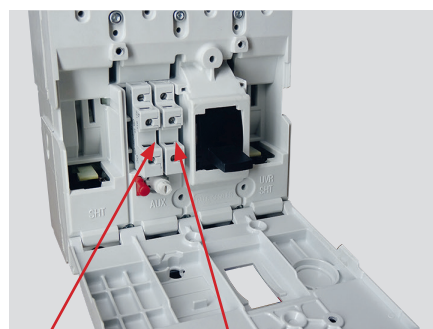
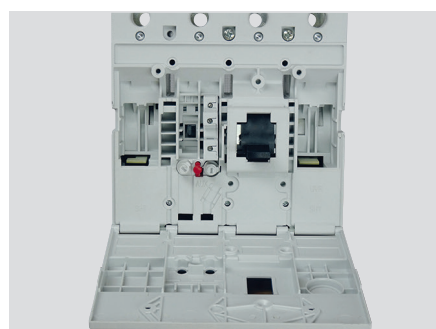

OC CTR

■ Connection - Cable outlets :

The cable outlet connections are the same as for the auxiliary contact (rear, side and top outlets).

■ Contact behavior

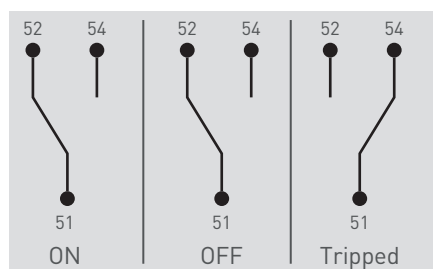

4 SHUNT TRIPS AND UNDERVOLTAGE RELEASES

■ Insertion, connection

Identical to the DPX³ 160 (see page 14).

5 FRONT MOTOR OPERATORS (CAT.NO 4 210 61)

As indicated for DPX³ 160 MCCBs, there is only one catalogue number for the front motor operator. This operator supports a range of voltages from 24 to 230 volts AC and DC.



■ Installing the motor

The front motor operator is installed in exactly the same way as for the DPX³ 160. (See the installation procedure described in the DPX³ 160 section on page 15).

■ Installing keylocks/padlocks :

- Padlocking and keylocking are the same as for DPX³ 160 models.
- See the DPX³ 160 section for the mounting procedure (page 16).

6 SIDE MOTOR OPERATORS (CAT.NO 4 210 60)

As for the front motor operator, there is only one catalogue number for the side motor operator for the entire DPX³ 160/250 range (Cat.No 4 210 60).

It is installed on the right-hand side of the circuit breaker but only using the Omega rail adaptor, Cat.No 4 210 69. Interlocking is not possible with 2 DPX³ 250 MCCBs equipped with side motor operators.

■ Installing the motor



Before installing the motor, you must first position the motor mounting support.

The mounting position is indicated on the support by an arrow.

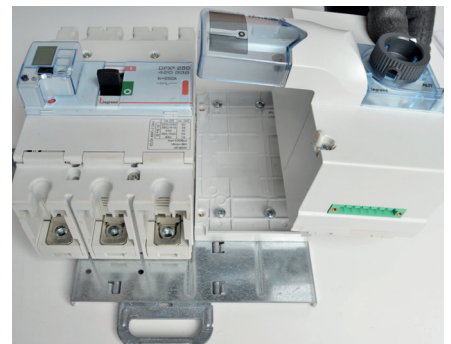

Then place the motor on its support (taking care to insert the motor attachment correctly onto the circuit breaker switch handle).

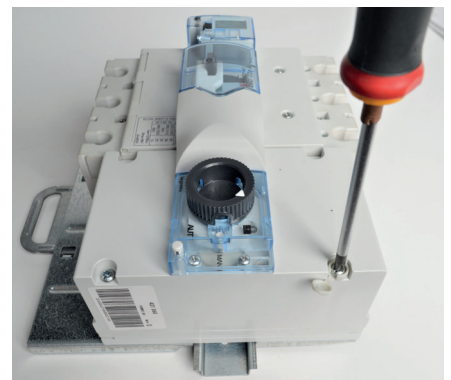

It is possible to seal one of the motor mounting screws.



Cat.no 4 210 60



Cat.no 4 210 69



Attach the motor mounting support to the adaptor (here, for a DPX³ 250, the width adaptor plate is not required).



Install the circuit breaker.

6 SIDE MOTOR OPERATORS (CAT.NO 4 210 60) (CONTINUED)

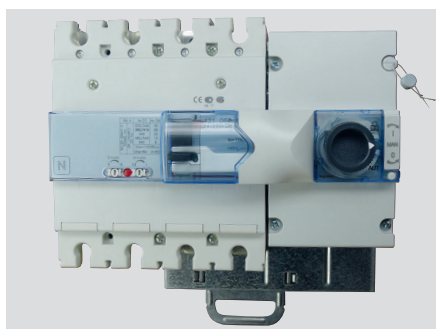

As with the front motor operator, it is possible to operate the circuit breaker manually using a key in the side motor operator. Simply turn the rotary knob to the manual position, insert the key in the hole and turn it to open or close the circuit breaker.



Installing keylocks/padlocks

The padlocking and keylocking accessories are the same across the entire range. See the DPX³ 160 section for the mounting procedure (page 16).

7 BATTERIES - CAT.NO 4 210 82

Function

The internal batteries allow the protection unit on electronic DPX³ MCCBs and/or DPX³ MCCBs with earth leakage module to be set in the workshop before installation.

Insertion

The batteries are installed in exactly the same way as for a DPX³ 160 (see the DPX³ 160 section - page 17).



The protection unit indicates when the batteries need replacing on the front panel. Protection is provided even if the batteries are discharged or removed.

8 EXTERNAL POWER SUPPLY CAT.NO 4 210 83



Function

This is used to power the DPX³ electronic protection units when the circuit breaker is open (in the OFF position) and or when there is not enough current flowing through it. It can be used to power several circuit breakers (maximum output 250 mA up to 5 electronic DPX³ 250 or up to 4 DPX³ 250 electronic with integrated measurement). Wires are supplied ready-equipped with a specific connector and are connected on the side of the circuit breaker.

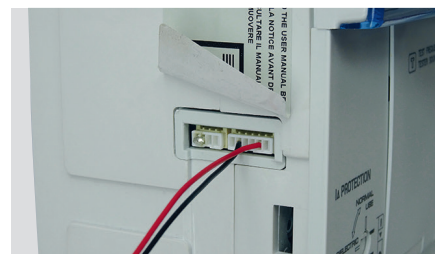

Diagram

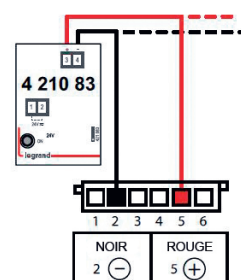

DPX³ 250 mechanical accessories

1 LIST OF CATALOGUE NUMBERS

CAT.NO	DESCRIPTION
Supply inverters	
	Plate for rail mounting and interlocking 2 DPX ³ MCCBs Used to build a supply inverter with 2 DPX ³ 160, 2 DPX ³ 250 or 1 DPX ³ 160 and 1 DPX ³ 250
4 210 58	DPX ³ supply inverter, fixed version
4 210 59	DPX ³ supply inverter, plug-in version
Rotary handles	
Direct rotary handles (fixed)	
4 210 00	Standard handle for thermal-magnetic DPX ³ without earth leakage module
4 210 01	Standard handle for electronic DPX ³ and DPX ³ with earth leakage module
4 210 02	Handle for emergency use for thermal-magnetic DPX ³ without earth leakage module
4 210 03	Handle for emergency use for electronic DPX ³ and DPX ³ with earth leakage module
4 201 60	Standard handle
4 201 73	Emergency handle
Remote rotary handles	
4 210 04	Standard handle
4 210 05	Emergency handle
4 201 61	Standard handle
4 201 74	Emergency handle
Accessories for locking rotary handles in the OFF position (Fixed)	
4 210 06	Barrel with flat key No. ABA90GEL6149 for direct handles
4 210 07	Barrel with star key No. HBA90GPS6149 for direct handles
4 210 08	Barrel with flat key No. ABA90GEL6149 for remote handles
4 210 09	Barrel with star key No. HBA90GPS6149 for remote handles
4 228 00	Key barrel and Ronis key EL43525 for direct handle
4 228 01	Key barrel and Ronis key EL43363 for direct handle
4 228 02	Key barrel and Ronis key EL43525 for vari-depth handle
4 228 03	Key barrel and Ronis key EL43363 for vari-depth handle
Accessories for locking rotary handles in the ON position	
4 201 64	Key barrel for direct handle
4 201 65	Key barrel and Ronis key EL43525 for direct handle
4 201 66	Key barrel and Ronis key EL43363 for direct handle
4 201 67	Key barrel and Ronis key for remote handle
4 201 68	Key barrel and Ronis key EL43525 for remote handle
4 201 69	Key barrel and Ronis key EL43363 for remote handle

CAT.NO	DESCRIPTION
Locking accessories	
4 210 49	Padlocking accessory for locking in the OFF position
4 210 45	Barrel with flat key No. ABA90GEL6149 for plug-in bases
4 210 46	Barrel with star key No. HBA90GPS6149 for plug-in bases
4 210 47	Padlocking accessory for plug-in bases

2 MOUNTING DPX³ 250 ON RAIL DIN

■ **Height spacer (Cat.No 4 052 26)**
The description and mounting procedure are the same as for the DPX³ 160 (see page 18).

■ **Fixing screw**
- Screw for panel mounting DPX³ MCCBs, Cat.No 4 210 81, length 70 mm, supplied with washer and nut.
- Screw for mounting DPX³ MCCBs on adaptors for \perp : rail mounting, Cat.No 4 210 84, length 65.5 mm.

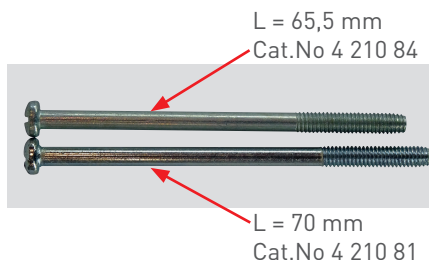

3 PLUG-IN BASE (CAT.NO 4 210 42/43)

■ **Front/rear-connecting base**
- Preparing the DPX³ 250
- Set of connectors

See the mounting procedures in the DPX³ 160 section (pages 19 to 23).

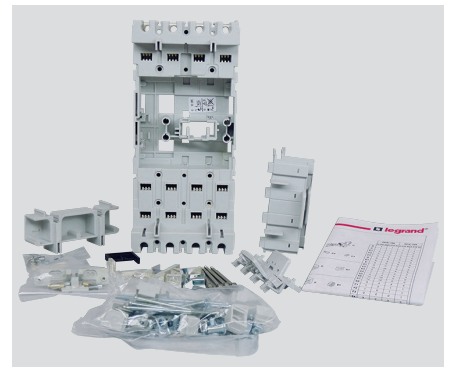

■ **Connection**
- Front terminals

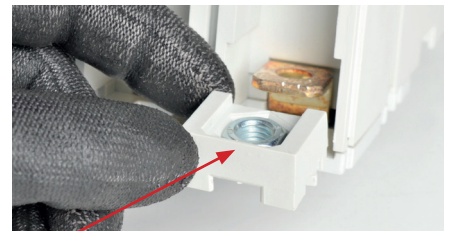

Screw terminals for lugs: supplied with the base.

Cage terminals for flexible or rigid cables, lugs and bars: use the high capacity cage terminals Cat.No 4 210 30 (set of 3 terminals) or 4 210 31 (set of 4 terminals).



3 PLUG-IN BASE (CAT.NO 4 210 42/43) (CONTINUED)

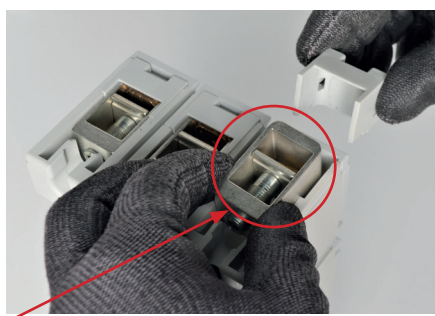

Cage terminal supplied with the DPX³



- Rear terminals Cat.No 4 210 38
(set of 3), 4 210 39 (set of 4).



The mounting procedure is the same as for the DPX³ 160 (see page 22).

■ Keylocks (Cat.No 4 210 45/46)

- See the mounting procedure in the DPX³ 160 section (page 23).

■ Padlocking accessory (4 210 47)

- See the mounting procedure in the DPX³ 160 section (page 23).

4 DIRECT ROTARY HANDLE

■ Mounting - Locking in the OFF position - Padlocking - Auxiliary contacts - Functions available with rotary handle

Identical to the DPX³ 160 (see pages 23 to 26).

5 REMOTE ROTARY HANDLE

■ Mounting - Keylocks - Padlocking - Auxiliary contact - Remote rotary handle option

Identical to the DPX³ 160 (see page 26).

6 TERMINAL SHIELDS CAT.NOS 4 210 52/53/56/57

■ Mounting :

Identical to the DPX³ 160 (see page 28).



Cat.No 4 210 57

for front terminals

Cat.No 4 210 53

for rear terminals

■ Sealing

Identical procedure to the DPX³ 160 (see page 28).

7 SWITCH HANDLE PADLOCKING ACCESSORY (CAT.NO 4 210 49)

Identical procedure to the DPX³ 160 (page 29).

8 SUPPLY INVERTER

■ List of catalogue numbers

- 4 210 58 : DPX³ supply inverter, fixed version

- 4 210 59 : DPX³ supply inverter, plug-in version

■ Principle - Mounting

Identical to the DPX³ 160 (see pages 30 and 31)

■ Integration XL³ enclosures

It is possible to mount a supply inverter in XL³ 800 and XL³ 4000/6300 enclosures.

DPX³ 250 connections

1 HIGH CAPACITY CAGE TERMINALS CAT.NOS 4 210 30 (SET OF 3) & 4 210 31 (SET OF 4)

■ Photo Cat.No 4 210 31

In contrast to the high capacity cage terminals for DPX³ 160 models, these are not joined together.



■ Connection capacity

These terminals can be used for flexible 1 x 120 mm² or rigid 1 x 150 mm² copper and aluminium cables, 18 mm maximum bars, or 18 mm diameter lugs.

■ Mounting

They are mounted by simply inserting the terminals and the plastic protective cover on the circuit breaker poles.

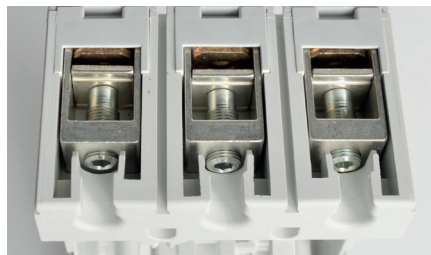

The photos below show the difference between screw terminal and cage terminal connections.

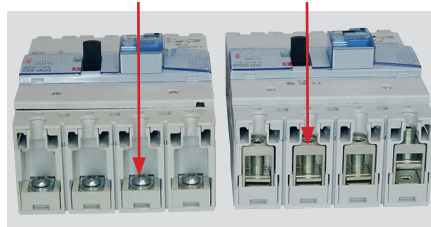

■ Tightening torque : 10 Nm

■ Terminal shields - 4 210 52/53/56/57

There are 4 catalogue numbers for the terminal shields which are the same as for the plug-in base: 2 for front terminals (3P and 4P) and 2 for rear terminals (3P and 4P).



Terminal shield for front terminals
Cat.No 4 210 57

Terminal shield for rear terminals
Cat.No 4 210 53

2 SCREW TERMINALS FOR LUGS : CAT.NO 4 210 79 (SET OF 3) CAT.NO 4 210 80 (SET OF 4)

■ Photo Cat.No 4 210 80



■ Connection capacity

- Maximum width : 28,5 mm
- Minimum hole diameter : 8 mm
- Maximum depth : 8,5 mm.

■ Mounting

- Insert the plastic insert into the slot with the square end facing outwards.



- Position the hexagonal nut in the slot on the larger of the 2 plastic inserts provided.



2 SCREW TERMINALS FOR LUGS :
CAT.NO 4 210 79 (SET OF 3)
CAT.NO 4 210 80
(SET OF 4) (CONTINUED)

- Insert the assembly behind the connection terminals on the circuit breaker.



- Attach the lug using the screw provided (tightening torque: 10 Nm).

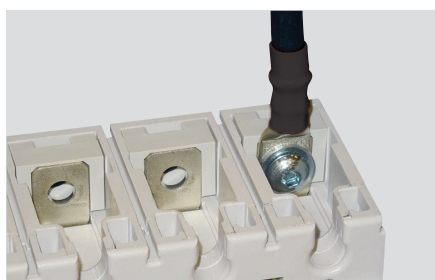

■ **Terminal shield**

Cat.Nos 4 210 5 (3-pole) or 4 210 57 (4-pole) are used for front connection terminals.

■ **Photo Cat.No 4 210 57**



3 CABLE SPREADERS
CAT.NO 4 210 34 (3 POLES)
CAT.NO 4 210 35 (4 POLES)

■ **Photo Cat.No 4 210 35**



■ **Connection capacity - Plan**

- Length : 25 mm
- Width : 17 mm
- Hole diameter : 8,4 mm
- Depth : 6 mm.

■ **Mounting**

Mounting on terminals for lugs Cat.No 4 210 79 (3P) or 4 210 80 (4P). Tightening torque 10 Nm. (see paragraph 2).

4 REAR TERMINALS -CAT.NOS 4 210 36 (SET OF 3) & 4 210 37 (SET OF 4)

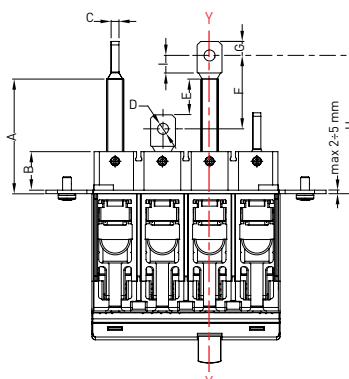

	A	B	C	D	E	F	G	H	I
DPX ³ 160	65,5	22	4,5	6,3	19,5	44	11	79	10
250	65,5	22	6	8,4	15,5	44	15	79	10

■ **Mounting**

- Identical procedure to the DPX³ 160.

■ **Terminal shield**

Cat.Nos 4 210 52 (3-pole) or 4 210 53 (4-pole) are used for rear terminals. Identical mounting procedure to the DPX³ 160 (see page 37).

5 INSULATION SHIELD
CAT.NO 4 210 70 (SET OF 36)

- **2 insulation shields are required (for the upstream device) for a DPX³ 3-pole MCCB and 3 are required for a DPX³ 4-pole MCCB.**

Example of mounting on a DPX³ 250 4-pole MCCB:

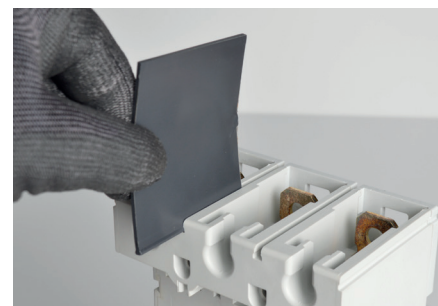

i It is mandatory to install the insulation shields supplied with the DPX³ on the upstream part.

INSTALLING THE DEVICES

In addition to ensuring installations and equipment are «made safe», the plug-in capability of DPX³ 160 and 250 MCCBs and trip-free switches represents a significant development in the functionality of these types of device.

FIXED VERSION

Fixed devices can be rail mounted or panel mounted.

Rail mounting :

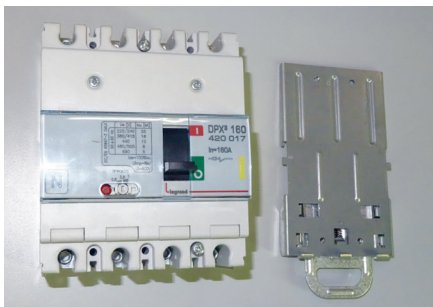

Panel mouting :



MINIMUM INSTALLATION DISTANCE

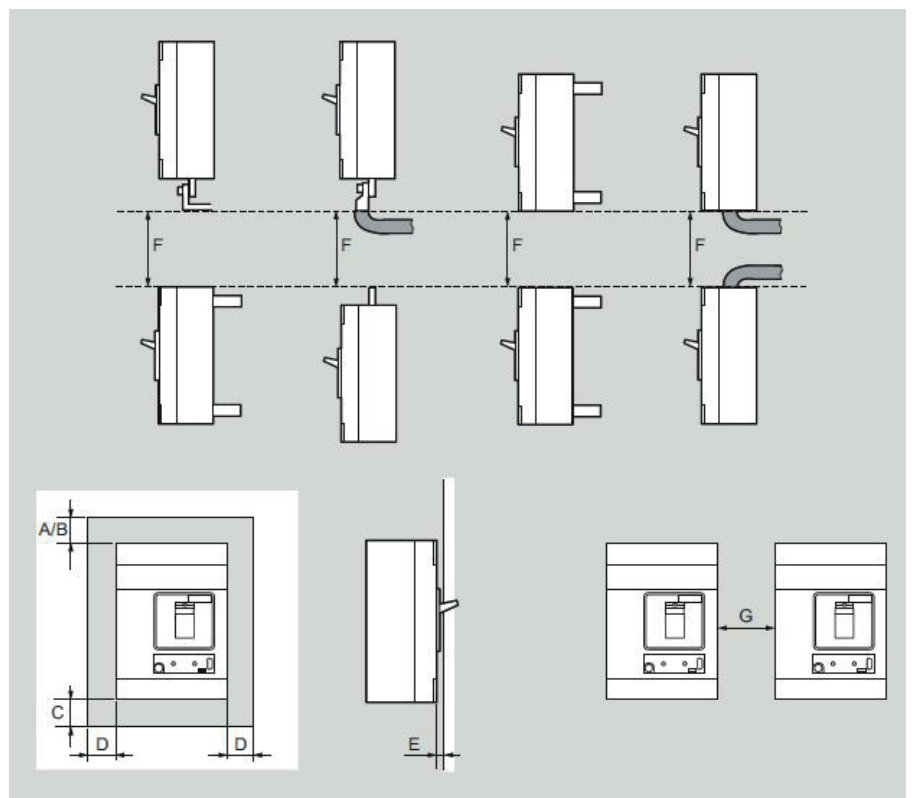

MINIMUM INSTALLATION DISTANCE							
	EARTHED PANEL	INSULATED PANEL	EARTHED PANEL	METAL PANEL	FACEPLATE	DISTANCE BETWEEN 2 CIRCUIT BREAKERS	
	A (mm)	B (mm)	C (mm)	D (mm)	E (mm)	F (mm)	G (mm)
DPX ³ 160	60	30	20	20	0	100	0
DPX ³ 250	60	30	20	20	0	100	0

PLUG-IN VERSION

Plug-in (or disconnectable) devices can be inserted or removed without powering down the relevant circuit. Connection and disconnection are only possible when the device is open (switch handle in the OFF position).

Plug-in devices can, in simple situations, be used for isolation and making safe, but their interchangeability makes them especially useful, particularly in terms of

simplifying maintenance.

They are sometimes designated by the letter D for "Disconnectable parts".

Before removing DPX³ MCCBs from their base, they must first be set to the OFF position. The fixing screws can then be loosened and removed using a screwdriver. To replace a DPX³ in its base, it must be set to the OFF position. It is also necessary to check that certain operating

precautions are met in terms of ratings, settings and types (trip-free switch or circuit breaker).

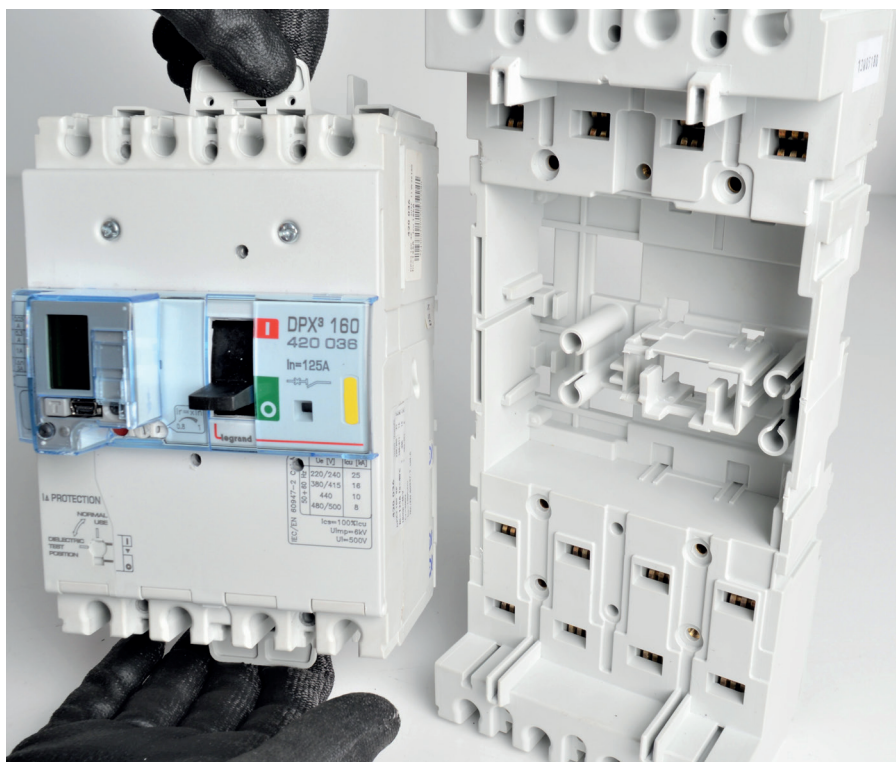

LOGICIEL PCS

Legrand power control station is intuitive and easy to use. It is a tool for consulting and testing the proper functioning of the electronic card that equips our electronic devices of the DMX³ range (except DMX³ 1600)-all electronic and thermal magnetic with integrated fault current protection DX³ add-on modules with integrated measurement-CX³ EMS. It is very useful for the maintenance service, to check the shape of the adjustment curve, to visualize the fault history and to check the different parameters directly on the device without touching the device. The software is available in 13 languages.

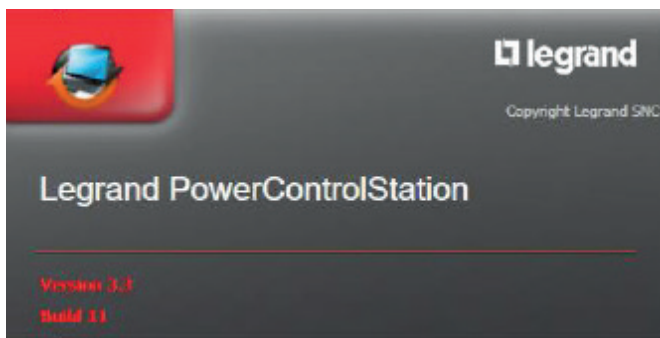

THE MINIMUM REQUIREMENTS OF THE COMPUTER TO RUN THE SOFTWARE :

- PC with Pentium III class processor
- Minimum RAM memory required 1GB, recommended 2GB
- Resolution 1024 x 768
- Colors 32 bit
- Pre-requisite mouse software
- Windows 7 or higher
- Microsoft.NET 4.0 or upgrade

■ Mini USB cable type B



The different access levels are available for each user category:

- Standard user → no password
- Business user → password 0000
- Legrand technical support → confidential
- Reserved area → confidential

COMPATIBILITY TABLE WITH VERSION 3.3 PCS :

Product	Version	Range	Minimum compatible version
DMX ³	MP4	2500-4000-6300	Screen software 2.5.5.X
	MP6	2500-4000-6300	Screen software 3.2.X

Product	Version	Range	Minimum compatible version
DPX ³	160	Thermal magnetic with earth fault protection	rev. 5 (*half 2016)
		Only earth fault protection	rev. 5 (*half 2016)
	250	Thermal magnetic with earth fault protection	rev. 5 (*half 2016)
		Only earth fault protection	rev. 5 (*half 2016)
		Electronic	rev. 4
	630	Electronic with earth fault protection	rev. 4
		Electronic	rev. 4
1600	Electronic	rev. 2	

The installation procedure and connection to the software, please refer to the instructions LE08866AB.

The different functions of the software :

- Firmware update: run the device firmware update feature. This operation is reserved exclusively for Legrand qualified personnel.

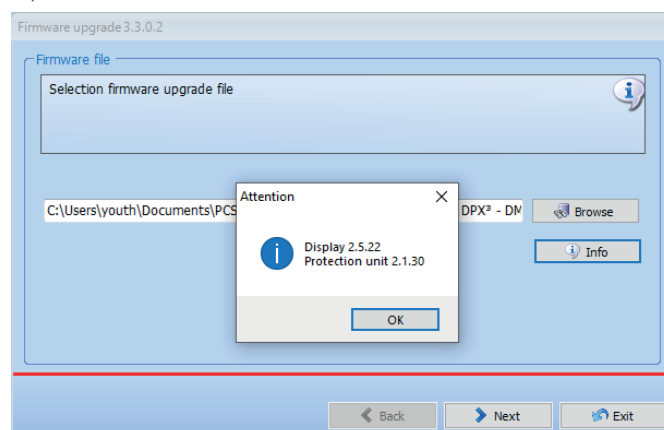

- Print on the file: create a complete file containing all the data read by the software and present on the device. ("..\Documents\legrand\legrand_powercontrolstation_03xx \ log").

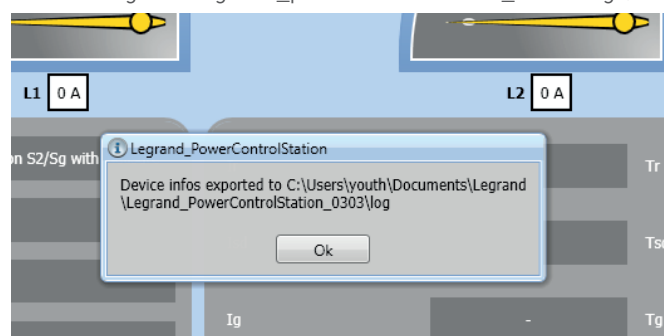

- Start monitoring: read the device information (versions – parameters – fault histories, etc.). The different pages of readings :

The yellow/white bar at the bottom of the page on the right is activated.

■ Home page

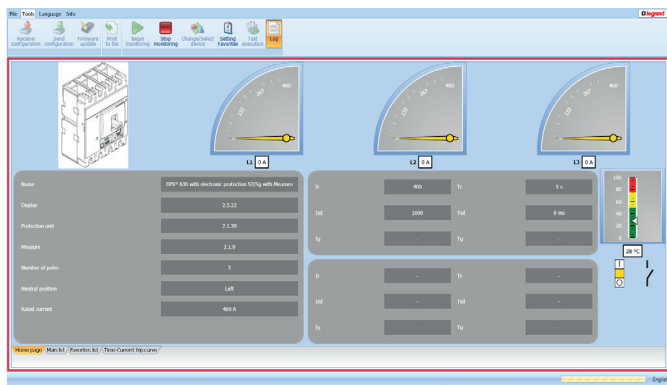

■ General list

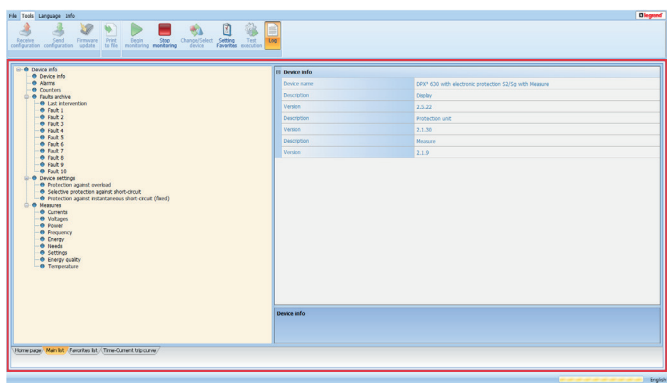

■ Favorites list

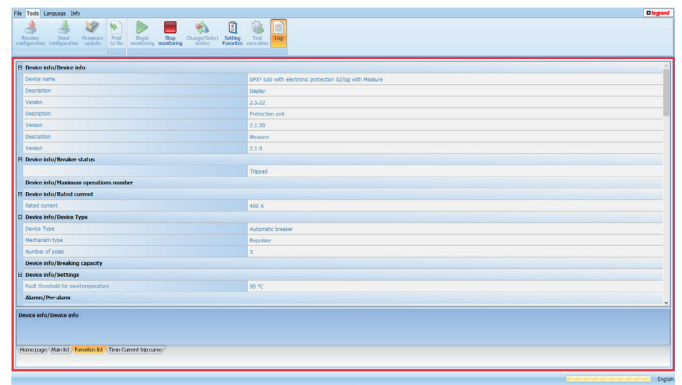

■ Tripping curves

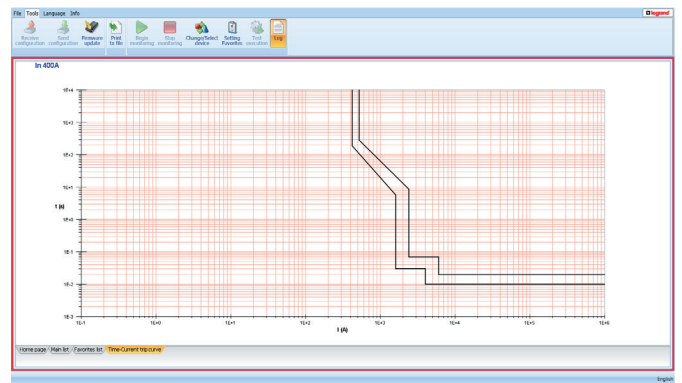

• Stop monitoring: stop playback of the device (the yellow/white bar at the bottom of the page on the right is no longer active).

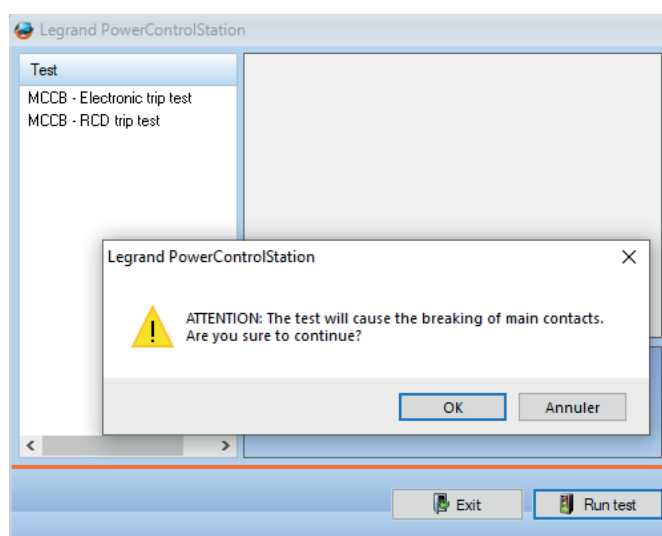
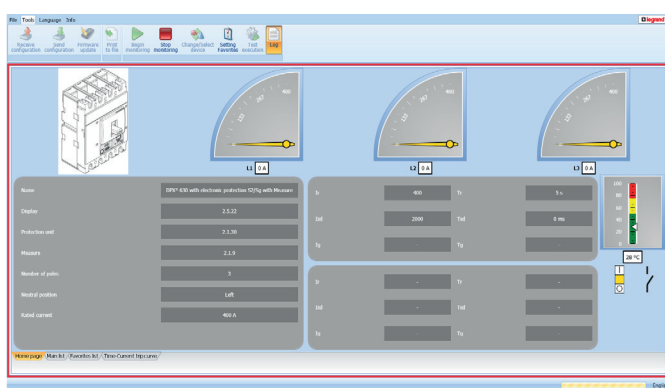

- Change/select device: in case of a prolonged shutdown, click on this tab to refresh the connection with the connected device.
- Favorite setting: in this tab, you can find all the information gathered on a single tab, version of the device, its settings, defect histories, etc...
- Test run: allow the device to be checked for proper operation. Attention, to ensure proper operation of this test, it is imperative to check that the device is properly powered (external power supply for electronic circuit breaker and mains supply for differential circuit breaker).

- Log: create and save the different steps of communication with the device (for all operations of the firmware update, think about clicking "Log").

DEDICATED FUNCTIONS

Integrated measurement

The new DPX³ 250 electronic MCCBs with integrated measurement make it very easy to monitor the parameters of different circuits in an installation without the need for any external device, current transformer or additional voltage measurement input.

The measurement data can also be displayed remotely on a PC equipped with control & management software, via the communication interface Cat.No 0 046 89.

The integrated measurement function is available on the DPX³ 250, provided that the DPX³ electronic module is powered by the external power supply Cat.No 4 210 83 or via the MODBUS module Cat.No 4 210 75.

The measured values are displayed directly on the LCD screen on the front of the circuit breaker, or they can be made available remotely via the MODBUS network.

The measurement functionality of the electronic module is independent of the correct operation of the DPX³ protection function.

The internal batteries, inserted in the front panel of the device, allow the various protection parameters to be set and viewed without needing a mains power supply.

The integrated measurement function is available on the DMX³, DPX³ and DX³ ranges.

The touch screen Cat.No 0 261 56 installed on the enclosure door is an innovative solution for displaying data from up to 8 devices: DX³, DPX³, DMX³ or EMDX³ measurement control units.

Legrand also offers a comprehensive range of meters, measurement control units and current transformers for installations equipped with devices without integrated measurement functionality.



Refer to the technical guide: Energy Management in Electrical Panels, available to download from our website <http://https://www.export.legrand.com/>

THE MEASUREMENT INTEGRATED IN THE DPX³ 630-1600 ALLOWS A READING OF THE FOLLOWING VALUES, IN THE ORDER OF DISPLAY:

- I1 : Phase 1 current - A⁽¹⁾.
- I2 : Phase 2 current - A⁽¹⁾.
- I3 : Phase 3 current - A⁽¹⁾.
- In : Neutral current (for DPX3 4P) - A⁽¹⁾.
- IG : Earth current (for SG version) - A⁽¹⁾.
- U12 : Phase-to-phase voltage between phases 1 and 2 (for DPX3 3P/4P) - V.
- U23 : Phase-to-phase voltage between phases 2 and 3 (for DPX3 3P/4P) - V.
- U31 : Phase-to-phase voltage between phases 1 and 3 (for DPX3 3P/4P) - V.
- V1N : Phase-to-neutral voltage between neutral and phase 1 (for DPX3 4P) - V.
- V2N : Phase-to-neutral voltage between neutral and phase 2 (for DPX3 4P) - V.
- V3N : Phase-to-neutral voltage between neutral and phase 3 (for DPX3 4P) - V.
- Freq : Frequency - Hz.
- Ptot : Active power - kW.
- Qtot : Reactive power - kvar.
- PF : Power factor.
- Ep ↓ : Active energy consumed or restored meter, with energy flowing from upper terminals to lower terminals - kWh.
- Ep ↑ : Active energy consumed or restored meter, with energy flowing from lower terminals to upper terminals - kWh.
- Eq ↓ : Reactive energy consumed or restored meter, with energy flowing from upper terminals to lower terminals - kVarh.
- Eq ↑ : Reactive energy consumed or restored meter, with energy flowing from lower terminals to upper terminals - kVarh.
- THDU12 : Total harmonic distortion of phase-to-phase voltage between phases 1 and 2 (for DPX3 3P/4P) - %.
- THDU23 : Total harmonic distortion of phase-to-phase voltage between phases 2 and 3 (for DPX3 3P/4P) - %.
- THDU31 : Total harmonic distortion of phase-to-phase voltage between phases 1 and 3 (for DPX3 3P/4P) - %.
- THDU1N : Total harmonic distortion of phase-to-neutral voltage between neutral and phase 1 (for DPX3 4P) - %.
- THDU2N : Total harmonic distortion of phase-to-neutral voltage between neutral and phase 2 (for DPX3 4P) - %.
- THDU3N : Total harmonic distortion of phase-to-neutral voltage between neutral and phase 3 (for DPX3 4P) - %.
- THDI1 : Total harmonic distortion of phase 1 current - %.
- THDI2 : Total harmonic distortion of phase 2 current - %.
- THDI3 : Total harmonic distortion of phase 3 current - %.

⁽¹⁾Also accessible on electronic DPX3 models without a measurement unit..

 Press the Play button «▶» to scroll between values. It is not possible to go backwards; you have to scroll through a complete set of values to return to an earlier one.

Coordination

SELECTIVITY

There are a number of techniques for implementing selectivity:

- Current selectivity, used for terminal circuits which have low short-circuit levels
- Time selectivity, provided by a delay on the tripping of the upstream circuit breaker
- Energy selectivity, making optimum use of the characteristics of the Legrand devices
- Logic selectivity, making use of the communication possibilities between devices.

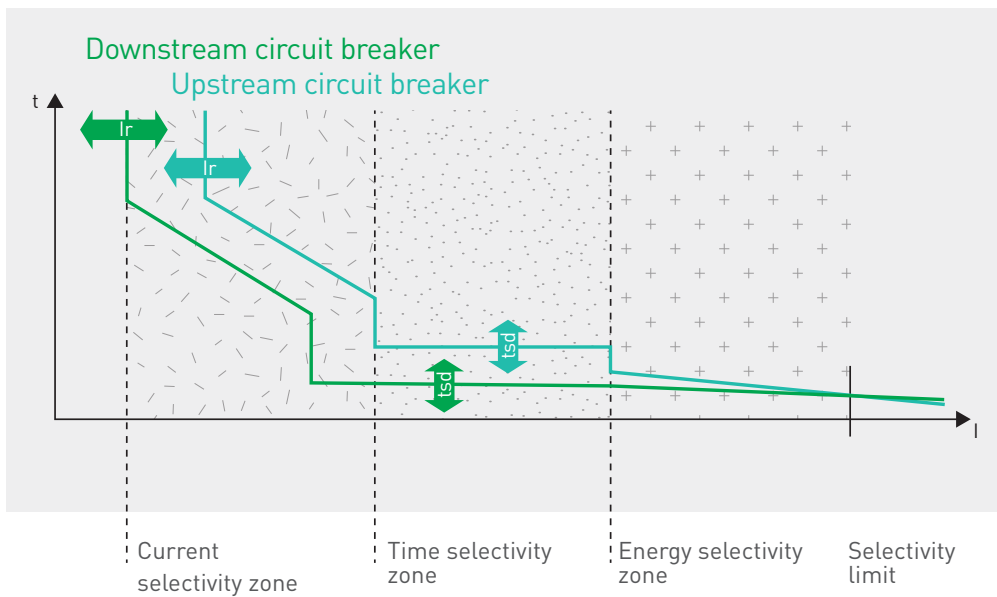

Refer to the technical guide: Coordination between Protection Devices, available to download from our website <http://https://www.export.legrand.com/>.

CASCADING

Cascading is a technique whereby the breaking capacity of a circuit breaker is increased by coordinating it with another protection device, placed upstream. This coordination makes it possible to use a protection device with a breaking capacity which is lower than the maximum prospective short-circuit current at its point of installation.

The breaking capacity of a protection device must be at least equal to the maximum short-circuit which may occur at the point at which this device is installed. In exceptional cases (NF C 15-100, Article 434.5), the breaking capacity of a device may be lower than the maximum prospective short-circuit, as long as:

- It is combined with a device upstream that has the necessary breaking capacity at its own point of installation.
- The downstream device and the protected trunking can withstand the energy limited by coordination between the devices.

Cascading can therefore offer the potential to make substantial savings.

The cascading values given in the tables on the catalogue pages are based on laboratory tests carried out in accordance with IEC 947-2.

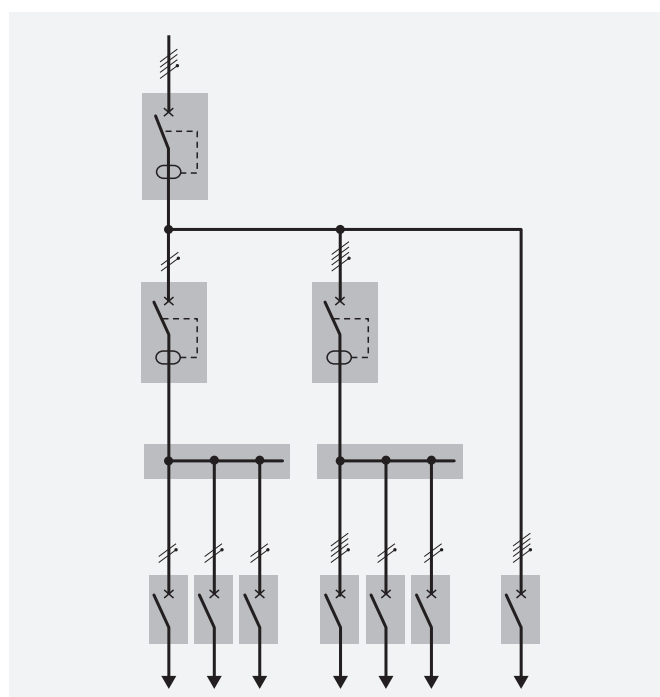

 For single phase circuits (protected by 1P+N or 2P circuit breakers) in a 380/415 V network, supplied upstream by a 3-phase circuit, it is advisable to use the coordination tables for 230 V.

COMMON ACCESSORIES

Fault signalling contact Cat.No 4 210 11

All DPX³ MCCBs and trip-free switches can be equipped with electrical auxiliaries to provide control and monitoring functions.

PRINCIPLE

The auxiliary/fault contact Cat.No 4 210 11 is common to the entire DPX³ range.

Depending on which location the changeover contact occupies in the slot on the DPX³, it acts as either an auxiliary contact or a fault signal contact.

The auxiliary contact (OC) is used to indicate the position of the main contacts on the circuit breaker or trip-free switch (open or closed) when it is operated via its switch handle.

It is neither an early make or a late break contact.

The fault contact (CTR) is used to provide remote feedback on circuit breaker opening following actuation of the release (thermal-magnetic, electronic or earth leakage module), test button, or the shunt trip or undervoltage release.

These are volt-free changeover contacts (NO-NC).

DIAGRAM

Representing a DPX³ in the open (OFF) position

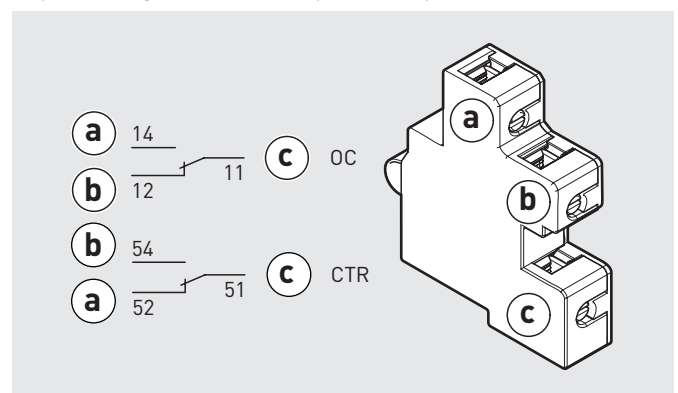

ELECTRICAL CHARACTERISTICS

TENSION	CURRENT RATING (A)
	RESISTIVE & INDUCTIVE LOAD
24 Vdc	10 / 5
48 Vdc	1,3 / 0,7
110 Vdc	0,4 / 0,3
230 Vdc	0,3 / 0,2
110 Vac	10 / 4
230 Vac	6 / 2

Shunt trip function

PRINCIPLE

Shunt trips are used to open a circuit breaker instantaneously (≤ 50 ms) by energising the coil: negative safety (controlled by external NO contact).

The contact incorporated in the shunt trip cuts the power to the coil on an open command.

DPX³ 160/250 :



DIAGRAM

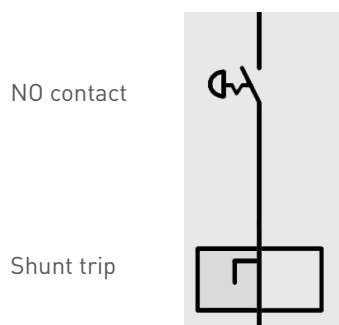

ELECTRICAL CHARACTERISTICS

	DPX ³ 160 - DPX ³ 250
Operating range	70 à 110 % Un
Response time	≤ 50 ms
Inrush power	400 VA/W
Inrush duration	> 50 ms
Insulation voltage	1,8 kV

CAT.NO	DESCRIPTION
4 210 12	12 V \sim and =
4 210 13	24 V \sim and =
4 210 14	48 V \sim and =
4 210 15	100-130 V \sim
4 210 16	200-277 V \sim
4 210 17	380-480 V \sim

Undervoltage release function

PRINCIPLE

Undervoltage releases are used to open a circuit breaker instantaneously (≤ 50 ms) by cutting power ($< 85\% U_n$) to the coil: positive safety (e.g. emergency stop by external NC contact).



DIAGRAM

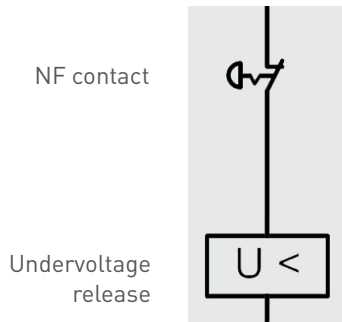

ELECTRICAL CHARACTERISTICS

	DPX ³ 160 - DPX ³ 250
Operating range	85 to 110 %
Response time	< 50 ms
Inrush power	1,6 W/5 VA
Holding power	1,6 W/5 VA
Insulation voltage	1,8 kV

CAT.NO	DESCRIPTION
4 210 18	12 V \sim and =
4 210 19	24 V \sim and =
4 210 20	48 V \sim and =
4 210 21	110-130 V \sim and 110 V =
4 210 22	200-240 V \sim
4 210 23	277 V \sim
4 210 24	380-415 V \sim
4 210 25	440-480 V \sim

Release for time lag undervoltage release (800 ms) Cat.No 4 210 98

PRINCIPLE

To be equipped with a time-lag module Cat.No 0 261 90 (230 V \sim) or 0 261 91 (400 V \sim) (400 V \sim), it prevents false tripping in the event of power supply microbreaks.

CAT.NOS

Release :
4 210 98

Time-lag module :
0 261 90



Motor operator function

PRINCIPLE

In automatic mode, the motor operator is used to open, close or reset a DPX³ 160 or 250 remotely.

In manual mode, the electrical commands are not taken into account; an Allen key is used to open and close the DPX³ manually. This key has its own slot on the front panel of the motor which can still be accessed even with the faceplate mounted.

In locked mode, it is impossible to control the motor electrically or manually. This mode is only possible if the DPX³ is in the OFF position, when it is then possible to padlock it (see page 16).

The motors are mounted on the front panel or on the side of the DPX³ 160 and DPX³ 250 MCCBs.

It is possible to use keylocking and padlocking accessories (Cat.Nos 4 210 62/.../67) to prevent the DPX³ from closing and cancel all electrical commands.

When the motor is removed from its base, a safety contact prevents motor operation to help ensure the safety of people and equipment.

SCHEMATIC DIAGRAM

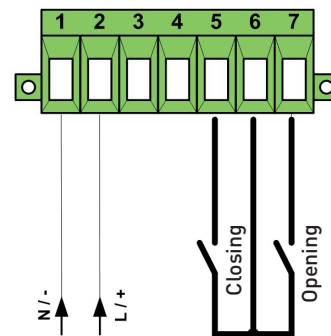

CAT.NOS

Side motor operator :
4 210 60

Front motor :
4 210 61

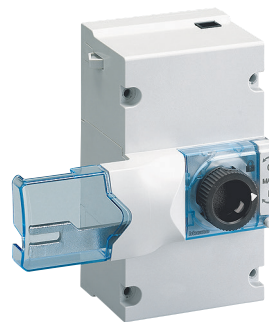

OPERATING

DPX³ 160 and 250 MCCB motors are equipped with an electronic module for opening and closing the associated DPX³. For this function to operate, the electronic module simply needs a power supply ranging from 24 to 230 V \sim or \equiv .

With the rotary knob in the AUTO position, the open and close commands must be volt-free, and the pulse duration must be at least 100 ms to be taken into account.

These commands are possible after a certain time delay (TC) which is applied after the motor has been powered up or after the rising edge of a command.

Between 2 separate commands, i.e. between the rising edge of the first command and the rising edge of the second, a delay (Ti) is necessary before the motor can take the second command into account.

ELECTRICAL CHARACTERISTICS

DPX³ 160/250 :

OPERATING VOLTAGE V _n (V)	Peak (W)	POWER (W)	CHARGING TIME READY FOR ACTION TC (s)		COMMAND RESPONSE TIME Ti (ms)	OPERATION Tf (ms)
			AC	DC		
24	40	4	2,3	1,6	3	80
48	40	4	0,9	0,85	3	80
110	40	4	0,6	0,6	3	80
230	40	4	0,5	0,5	3	80



If several motors are present in the same enclosure, it is necessary to always use the same phase.

Supply inverter

PRINCIPLE

The supply inversion device ensures continuity of operation by switching over to a standby power source if there is a fault on the main supply. This supply inversion is carried out totally safely by means of mechanical and electrical interlocking devices via the automation control unit.

Depending on the degree of automation of the function, it can be classified into three categories:

- **Manual** : The simultaneous closing of both devices is prevented by a mechanical interlock device integrated in the devices' mounting support plate. It is only possible to close one device if the other device is open.
- **Remote control** : The devices are equipped with motor operators. The closing and opening operations are therefore carried out remotely. The electrical layout and the control system must be designed on a case by case basis depending on requirements.
- **Automatic** : An automation control unit manages the inversion. The switchover to the standby power source is carried out automatically if there is a fault on the main supply, and vice versa after restoration of this supply. The automation control unit can manage the secondary (generator) power source.

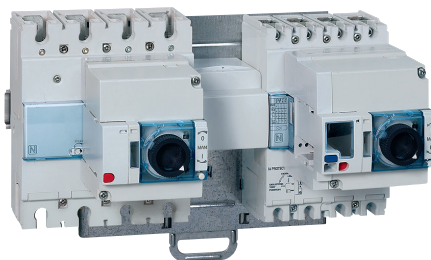

 It is possible to mix DPX³ 160 and DPX³ 250 devices to build supply inverters.

 The new ATS range includes 3 types of automatic transfer switch control units. They can be used to set the operation in case of source inversion, by switching a product to «ON» or «OFF».

The choice of this control unit depends on the desired level of service and the complexity of the installation.

Integrated residual current protection function

PRINCIPLE

DPX³ MCCBs and trip-free switches offer an integrated residual current protection option. This function provides protection against indirect contact. In the DPX³ models equipped with this protection device, the trip solenoid must not be removed.

DIELECTRIC TEST SWITCH

In order to provide an actual insulation impedance measurement, a mechanical selector switch on the DPX³ front panel allows the circuit breaker to be insulated during the dielectric tests.

Before this mechanism is activated, the DPX³ must first be set to the OFF position. To reactivate the DPX³ once the dielectric tests are complete, it is necessary to reset the mechanism back to its normal position, reclose the valve, then reset the DPX³ by setting its switch handle to the OFF position.

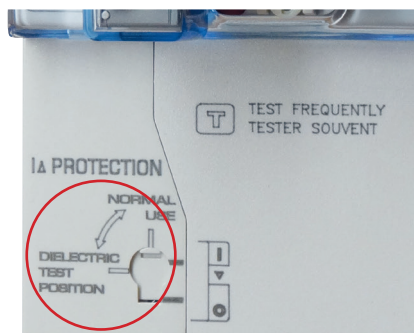

VIEWING AND SETTING PARAMETERS

The residual current protection parameters can be viewed and configured on the LCD screen on the front of the DPX³.

Press the « ► » button to view the parameters.

Press “+” to modify a parameter setting.

The « ► » button is used to scroll to the next menu.

It is possible to view and set the different residual current parameters in the following conditions:

- When the operating status batteries are used.
- When there is voltage at the lower power terminals (DPX³ open with power supplied via the lower terminals, or DPX³ in the closed (ON) position and energised).
- With external power supply Cat.No 4 210 83 (for electronic DPX³ 250).
- With the MODBUS communication module Cat.No 4 210 75 (for electronic DPX³ 250).

The access panel to the “+” settings button can be sealed to prevent any modification.

The different residual current protection settings are summarised in the tables on pages 11 and 40. Note that the I Δ n setting 0.03 A cannot be delayed, and is thus automatically set to instantaneous. This time delay cannot be modified subsequently as long as I Δ n is set to 0.03 A.

COMMON ACCESSORIES

OPERATION TEST

The residual current protection function can be tested by pressing the "T" button. This test is only possible if the DPX³ is in the closed (ON) position and energised, or if the DPX³ is open with its power supplied via the lower terminals. It is not possible to run this test with just the batteries.

This test does not take account of the set time delay; the DPX³ therefore trips instantaneously, causing the indicator on the front panel, the fault contact and the "ECTR/RCD" contact to change state.

DIAGRAM

ECTR / RCD contact

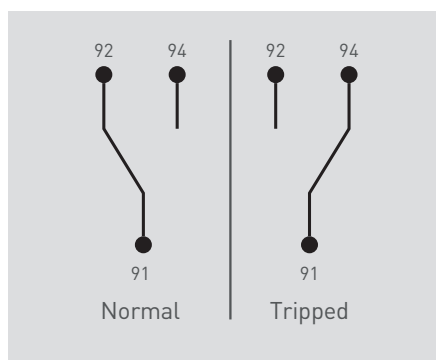

ELECTRICAL CHARACTERISTICS

3 A/230 Vac

INDICATOR



Yellow : Tripped on residual current fault

CONTACT TERMINALS

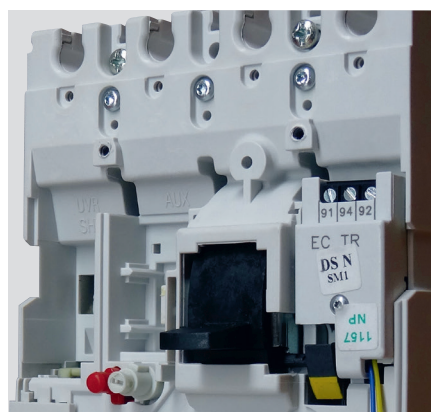

CURVES

The tripping curves illustrated in the installation instructions represent the maximum response times.

Example of a curve with a delay time set to «instantaneous».

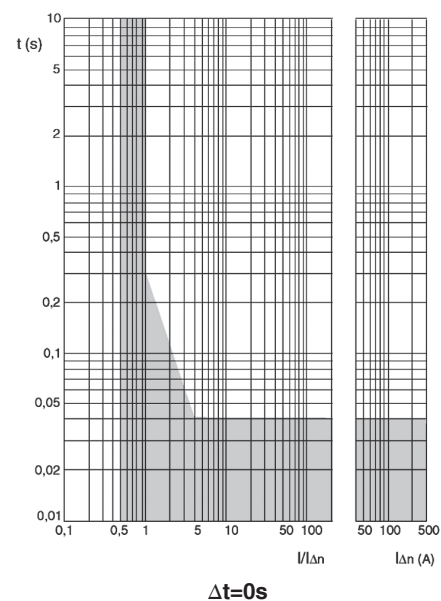

Residual current relay function

Cat.No 0 260 88

PRINCIPLE

Residual current relays provide a residual current protection function for DPX³ MCCBs and trip-free switches which are not equipped with an earth leakage module as standard, but which must be equipped with a release.

DIAGRAMS

When using an undervoltage release, it is necessary to reset the DPX³.

■ Positive safety, switch set to Nd

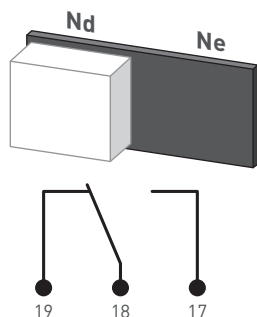

Position of contacts according to the powered device.

Caution: In the event of a current transformer-relay connection fault, the contact closes between terminals 17 and 18 independently of the position set on the selector switch.

The contact also closes between 17 and 18 if there is no voltage (the associated circuit breaker opens).

With shunt trip:

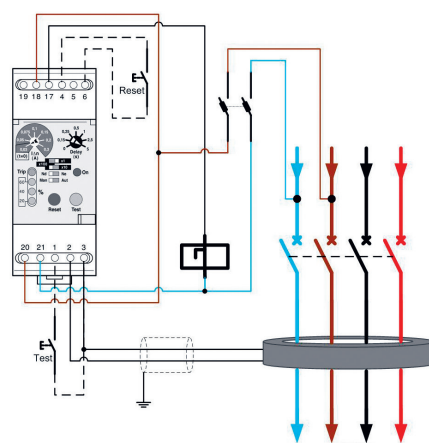

With undervoltage release:

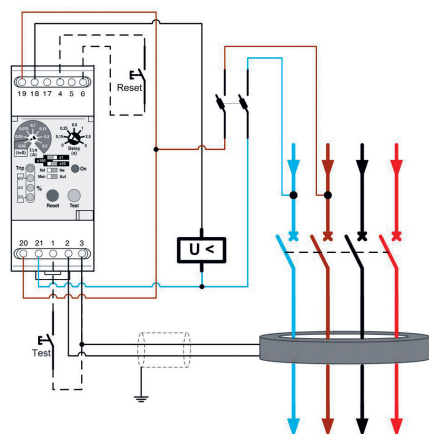

■ Standard safety, switch set to Ne

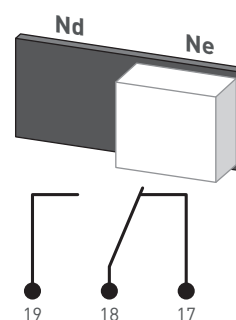

Position of contacts according to the powered device.

Caution: In the event of a current transformer-relay connection fault, the contact closes between terminals 18 and 19 independently of the position set on the selector switch.

i All active conductors must feed through the current transformer for the relay to function correctly.

FRONT PANEL

- 1 - $I_{\Delta n}$ setting.
- 2 - Test button.
- 3 - Reset button.
- 4 - Device power on indicator (green).
- 5 - Residual current relay trip indicator (red)/relay-current transformer connection fault (red flashing).
- 6 - Time delay setting.
- 7 - Selection of the $I_{\Delta n}$ rating multiple.
- 8 - Selection of the reset mode.
- 9 - Selection of the output relay status.
- 10 - Indication of the fault current as a % $I_{\Delta n}$.

SETTINGS

■ Sensitivity setting $I_{\Delta n}$

The sensitivity of the residual current relay is obtained by an initial combination on switch ⑦ which determines the multiple to be applied to the rotary knob ① which selects the $I_{\Delta n}$ setting.

The minimum sensitivity level can vary depending on the current transformer used. If the $I_{\Delta n}$ value set is less than its minimum value, it is the current transformer's minimum value which is taken into account.

Time delay

The time delay is used to delay tripping of the associated DPX3 if the fault persists during this period.

With a $I_{\Delta n}$ setting of 0.03 A, tripping will be instantaneous, regardless of the time delay set.

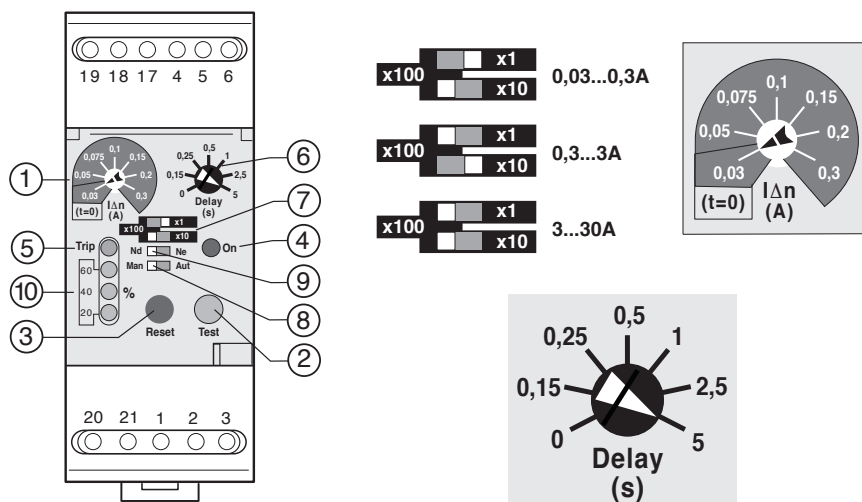

The residual current relay must be set according to the time and sensitivity selectivity requirement between residual current devices.

CURRENT TRANSFORMER CHARACTERISTICS

CT	0 260 92	0 260 93	0 260 94	0 260 95	0 260 96	0 260 97	0 260 98
Diame- ter (mm)	35	80	110	140	210	150	310
I Δ n - mini (mA)	30	50	100	300	300	500	1000
I _n (A)	70	170	250	250	400	250	630
I _{max} = (6×I _n)	420	1020	1500	1500	2400	1500	3780

■ Choice & Recommendation :

This depends on the minimum value of the residual current to be detected and the inner diameter of the coil to pass all active conductors.

For a high transient current application, the standard requires the manufacturer to have a maximum test threshold of 6 x I_n (Immunity against false zero sequence currents according to EN / IEC 60947-2 appendix M).

Example 1 : An installation composed of ventilation systems with a rated current I_n of 150 A.

According to EN / IEC 60947-2 Appendix M, the coil to be chosen is Cat.No 0 260 93:

$$I_n = 170 \text{ A}$$

$$6 \times I_n = 1020 \text{ A}$$

For an application with a low transient current of less than 6 x I_n, this formula below can be applied 6 x I_n (see table above)
I_n (nominal current of the device)

Example 2 : For coil Cat.No 0 260 93 with one device I_n 150

$$= 6,8$$

$$1020$$

$$150$$

The maximum permissible overload is 6.8 x I_n

I Δ n mini : minimum threshold to be set on the earth fault relay according to the size of the coil to avoid unintentional tripping.

I_n : nominal current of the device.

I_{max} : see Choice & Recommendation.

To ensure proper operation of the earth fault relay, please follow the recommendations below :

- Minimize the distance between the coil and the earth fault relay.
- Use shielded or twisted cables.
- Do not run the connection cables of the coil and the earth fault relay in parallel with the power conductors or near electromagnetic fields (e. g. high voltage transformer).
- For optimal accuracy, the conductors must be centered in the coil.
- Different implementation possibilities:

Case 1 - Flexible or conductive bars, it is necessary to ensure that the 4 active conductors are inside the coil and centered

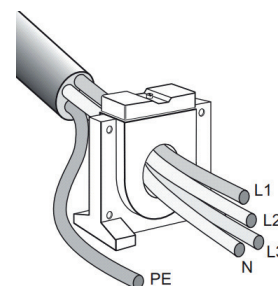

Case 2 - By 5G cable for example, in case the PE passes through the coil, then this conductor must be replaced in the opposite direction to regularize the field as shown in the image below.

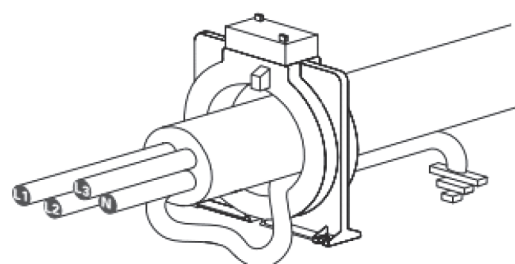

SPARE PARTS & ACCESSORIES

There is a wide range of spare parts available for DPX³ MCCBs and their accessories.

CAT.NO	DESCRIPTION	CONTENTS		DEVICE
4 210 93	High capacity cage terminals		Components for 1 x 3P MCCBs, set of 3 terminals	DPX ³ 160
4 210 94	High capacity cage terminals		Components for a 4P MCCB, set of 4 terminals	
4 210 28	Screw terminals for lugs		Components for 1 x 3P MCCBs, set of 3 terminals	
4 210 29	Screw terminals for lugs		Components for 1 x 4P MCCBs, set of 4 terminals	
4 210 96	Terminal shield, 4P (height 36 mm)		Components for 1 x 4P MCCBs (2 sides)	
4 210 90	Screw - Insert - Washer		Components for 1 x 3P or 1 x 4P MCCBs	
9 802 53	Screw terminals for lugs kit		Components for 1 x 3P and 1 x 4P MCCBs	
4 210 71	Fixing plate - for DPX ³ 160 3P/4P without earth leakage modules		x 1	
4 210 73	Fixing plate - for DPX ³ 160 4P with earth leakage modules		x 1	
4 210 68	Fixing plate - for DPX ³ 160 3P/4P with side mounting motor operator		x 1	

CAT.NO	DESCRIPTION	CONTENTS		DEVICE
4 210 79	Screw terminals for lugs		Components for 1 x 3P MCCBs, set of 3 terminals	DPX ³ 250
4 210 80	Screw terminals for lugs		Components for 1 x 4P MCCBs, set of 4 terminals	
4 210 97	Terminal shield 4P (height 55 mm)		Components for 1 x 4P MCCBs (2 sides)	
4 210 69	Fixing plate - for DPX ³ 250 3P/4P with side mounting motor operator		x 1	
4 210 72	Fixing plate - for DPX ³ 250 3P/4P without earth leakage modules		x 1	
4 210 74	Fixing plate - for DPX ³ 250 4P with earth leakage modules		x 1	
9 812 43	equipment RS485 module		x 1	
4 210 91	Screw - Insert - Washer		Components for 1 x 3P or 1 x 4P MCCBs	DPX ³ 250
9 802 54	Screw terminals for lugs kit		Components for 1 x 3P and 1 x 4P MCCBs	
4 210 82	Set of spare batteries		MCCB components	DPX ³ 160/250
4 210 70	Insulation shields		x 36	
4 210 81	Screw-nut-washer for panel mounting (70 mm screw + nut)		Components for 2 x 3P or 1 x 4P MCCBs (the set also contains a set of metric screws for mounting on generic panel)	
4 210 84	Screw for attaching to adaptor for rail mounting		Components for 6 x 3P or 6 x 4P MCCBs	
4 210 89	Mini USB cap		Components for 20 MCCBs	
4 210 92	Connector for external power supply		Components for 20 MCCBs	
4 210 95	Sealing kit		Components for 4 MCCBs	
4 210 48	Signalling contact plugged-in / drawn-out - for DPX ³ plug-in version		x1	

To know more,

check export.legrand.com



All technical data of the products inside this workshop specifications book are available on : www.export.legrand.com/en/documentations/

>Click on >DOCUMENTATIONS AND SOFTWARE

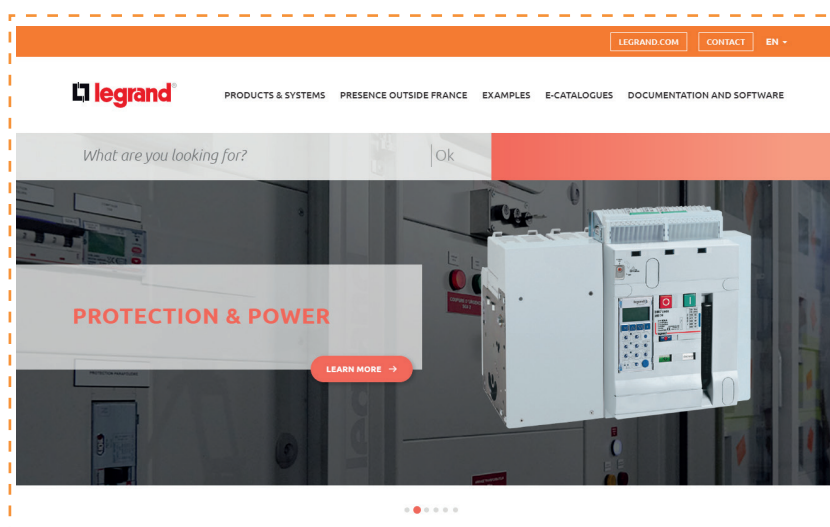

>Documentation

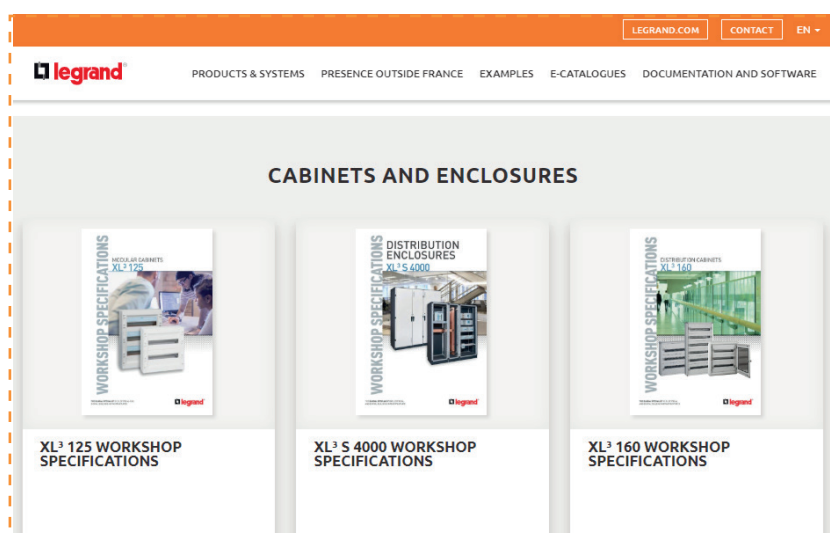



FOLLOW US
ALSO ON

- @ legrand.com
-  youtube.com/user/legrand
-  facebook.com/Legrand
-  twitter.com/Legrand
-  pinterest.com/legrandgroup
-  instagram.com/legrandnews



Head office
and International Department
87045 Limoges Cedex - France
Tel: + 33 (0) 5 55 06 87 87
Fax: + 33 (0) 5 55 06 74 55