

MyHOME_Up

HOME AUTOMATION EVOLUTION

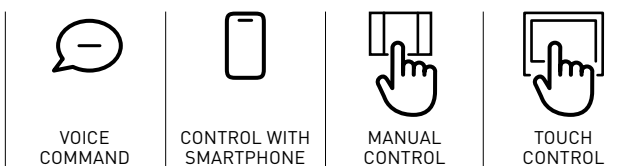
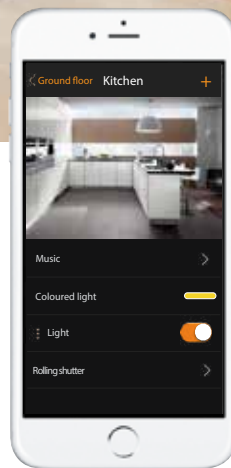

GUIDE
FOR INSTALLATION
AND CATALOGUE

MyHOME_Up

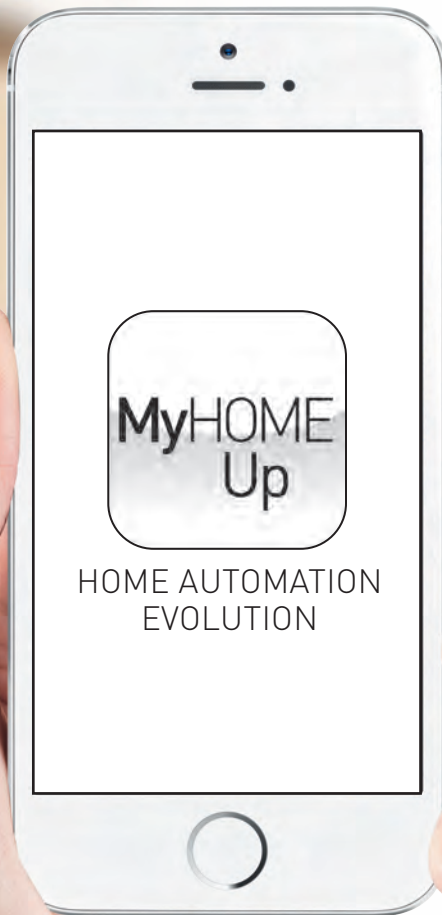

INTRODUCTION – PROJECT GUIDELINES

LIGHTS AND AUTOMATION

ENERGY MANAGEMENT

- Temperature control
- Load control and consumption display

SYSTEM INTEGRATION

SOFTWARE AND SERVICES – CATALOGUE – APPENDIX

CONTENTS

INTRODUCTION

General features 2

PROJECT GUIDELINES

General features 22
 Functional diagram of a **MyHOME_Up** system 22

Preliminary project and system layout 24
 The installation of a BUS system 24
 Light and automation system 28
 Temperature control system 29
 Consumption display and load control system 32
 Burglar-alarm system 34
 NUVO Multiroom audio system 35
 Selection and positioning of the electric panel 36
 Positioning of the junction boxes 44

LIGHTS AND AUTOMATION

General features	46
Light and shutter automation system	46
Wiring diagrams	64
Diagram 1 - Switching on and off of 2 lamps with 4 light points with general ON/OFF control	64
Diagram 2 - Automatic switching on of the light with passive infrared ceiling sensor.	64
Diagram 3 - Alternate current motor control for shutters, curtains, or motorised shutters	65
Diagram 4 - Switching on and off of one lamp and shutter control using an actuator control	65
Diagram 5 - Switching on, off and adjustment of the light level of fluorescent lamps through "ballast"	66
Diagram 6 - Switching on, off and adjustment of the light level of LED lamps.	66
Diagram 7 - Lighting system with presence and lighting sensors - large meeting room	67
Diagram 8 - Lighting system with presence and lighting sensors - hall and reception	68

ENERGY MANAGEMENT - TEMPERATURE CONTROL

General features	70
Temperature control.	70
General rules for installation	76
Sizing of the system	76
System physical expansion	76
Association of the devices.	77
Wiring diagrams	78
4-zone villa	78
3-zone villa	82

ENERGY MANAGEMENT - LOAD CONTROL AND CONSUMPTION DISPLAY

General features	84
Management and load control system	84
Consumption display and energy production.	85
Load control and consumption display	86
Wiring diagrams	89
Management and load control system	89
Three-phase load control management and single phase load with Bus SCS in common	90

FUNCTION INTEGRATION

General features	92
Function integration	92
Integration of light automation, load management, consumption display and temperature control systems.	94
Integration of MyHOME_Up systems with BTicino and/or third party systems	96

SOFTWARE AND SERVICES

General features	103
Home configurator Web App	103
YouDiagram software	104
MyHOME_SUITE	105
Services and digital tools	106

CATALOGUES

MyHOME_Up catalogue	108
MyHOME_Up FLATWALL catalogue	130
Appendix	142

GENERAL FEATURES

MyHOME_Up: home automation evolution

MyHOME_Up is the integrated modular home automation system based on the BUS technology with 2 wires pair that offers smart solutions in terms of:

- **comfort**, thanks to the custom setting of lights, shutters, temperature and music in every room.
- **safety** to prevent unwanted intrusions.
- **control of consumption and power levels** for energy and cost savings and to avoid overload black-outs.

MyHOME_Up is also an open system, able to integrate with **systems and devices of other brands** to perform advanced functions.

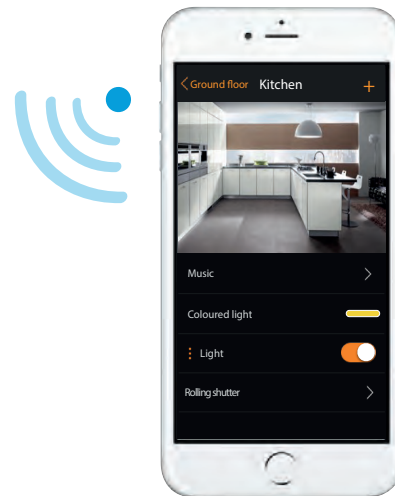

MyHOME_Up App

HOMETOUCH 7" Touch Screen Control

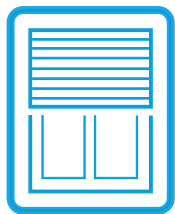
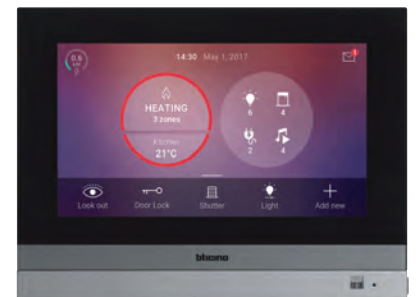

MyHOME_Up system

BUS



Digital controls

CONTROL MyHOME_UP AS YOU WISH

- All the functions may be managed:
- with voice commands using the Google Home and Amazon Alexa voice assistants.
 - using the Smartphone and dedicated app;
 - with flush-mounted manual controls;
 - with HOMETOUCH Touch Screen devices.

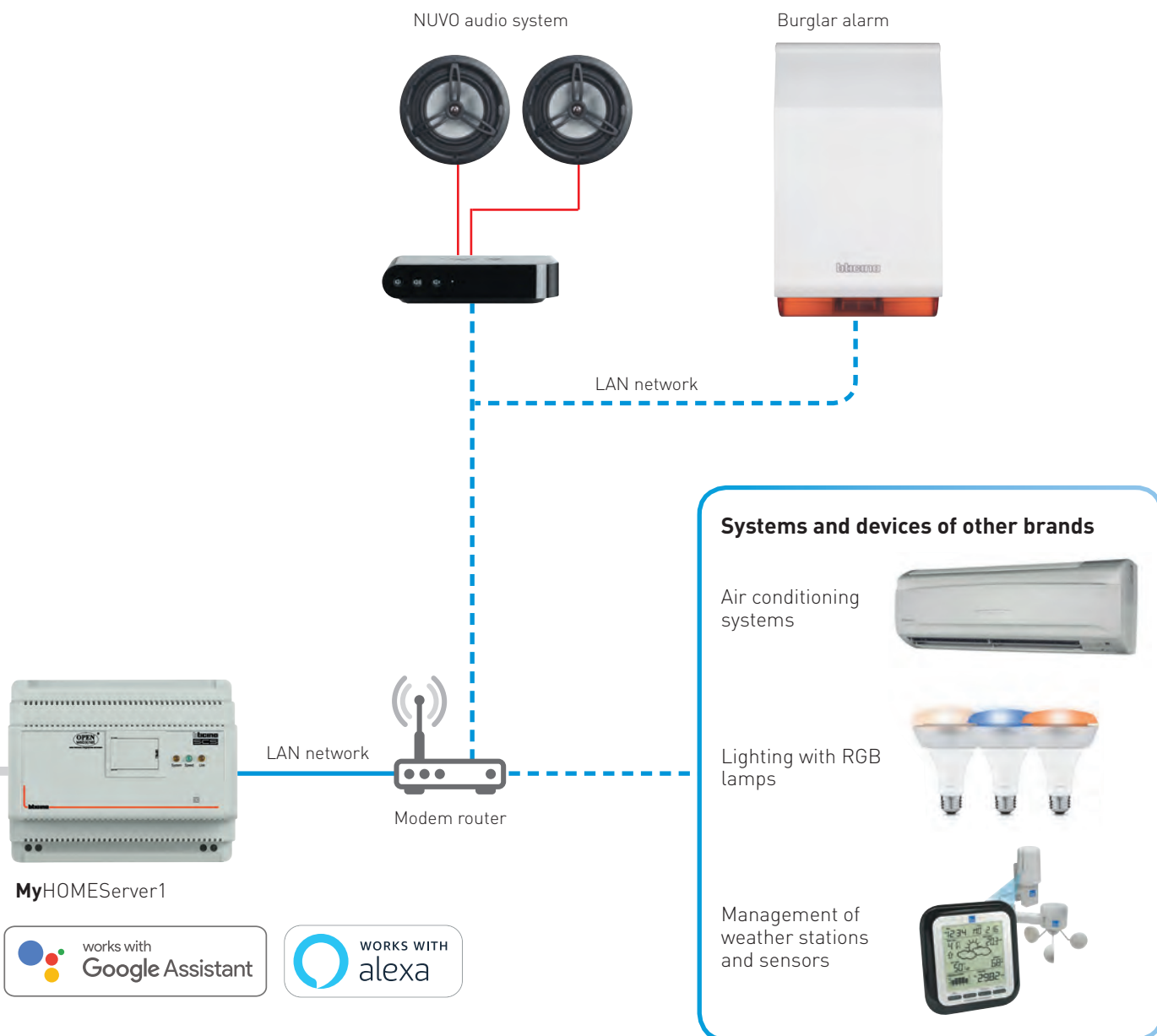
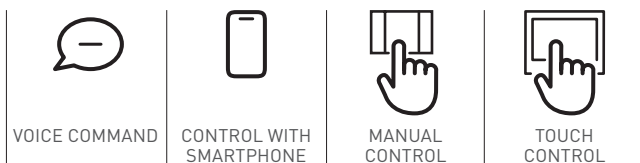

The system functions

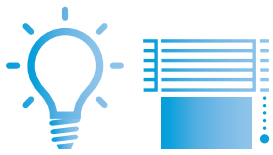

LIGHT AND AUTOMATION SYSTEM

System which can manage up to **175 channels (*)** (lamps, shutters, controlled sockets etc.).

MyHOME_Up application allows start up of the light and automation system and the check of the operation of the individual devices.

In particular it is possible to associate the devices found in the system and create single and general commands and groups of lights and shutters.

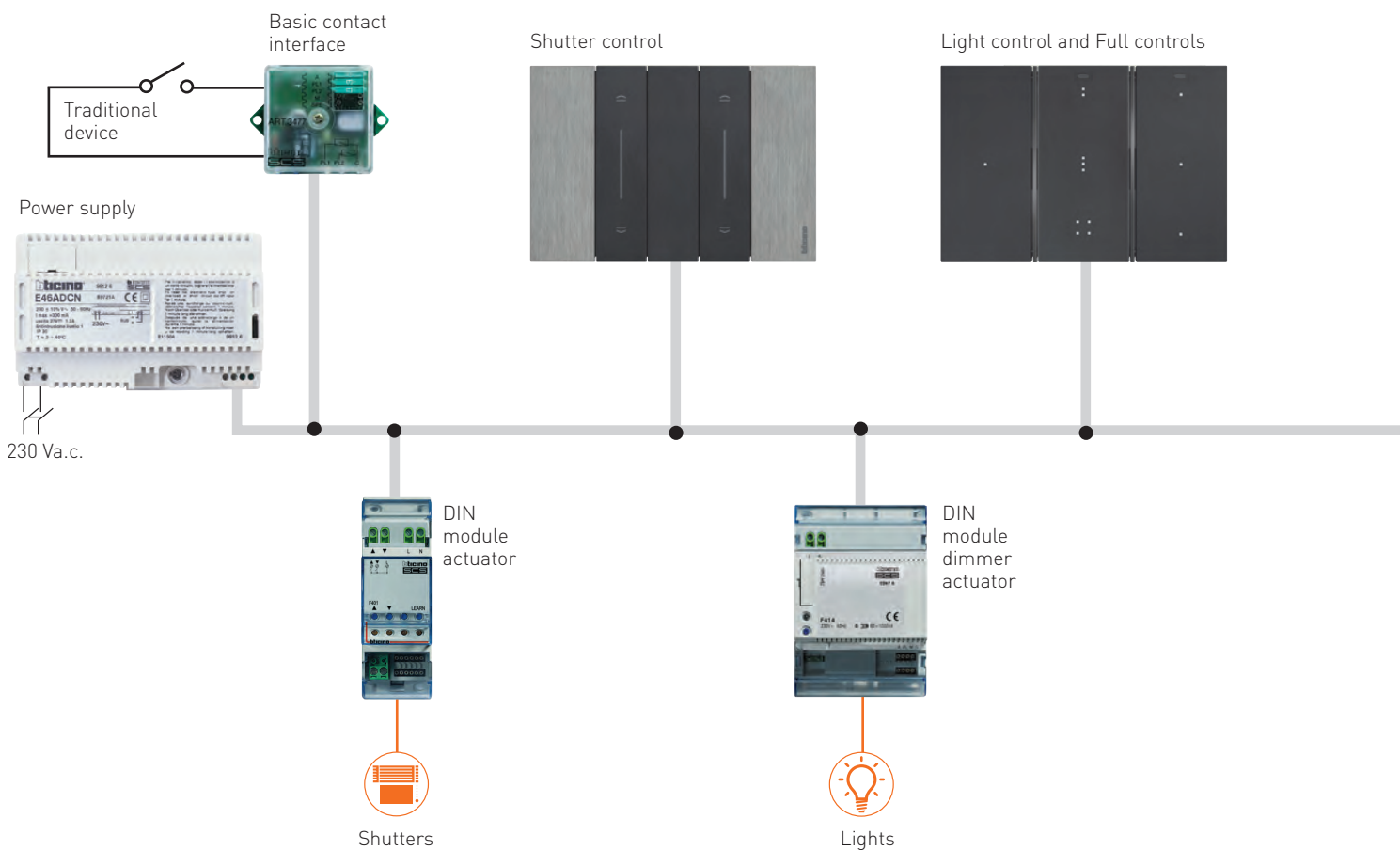

Note (*): Channel means the individual relay or output of the actuator for the management of the load. The count includes any preset or unused outputs. For example, actuator F411/4 with 4 independent relays is identified in the **MyHOME_Up** as a 4-channel device.

Manageable functions

- different lights and loads with ON/OFF and dimmed control;
- rolling shutters with UP/DOWN control and management of the preferred position;
- automatic switching on of loads as a function of presence (using sensors) or the closing of a contact (using contact interfaces).

Full controls



Voice control



HOMETOUCH 7"

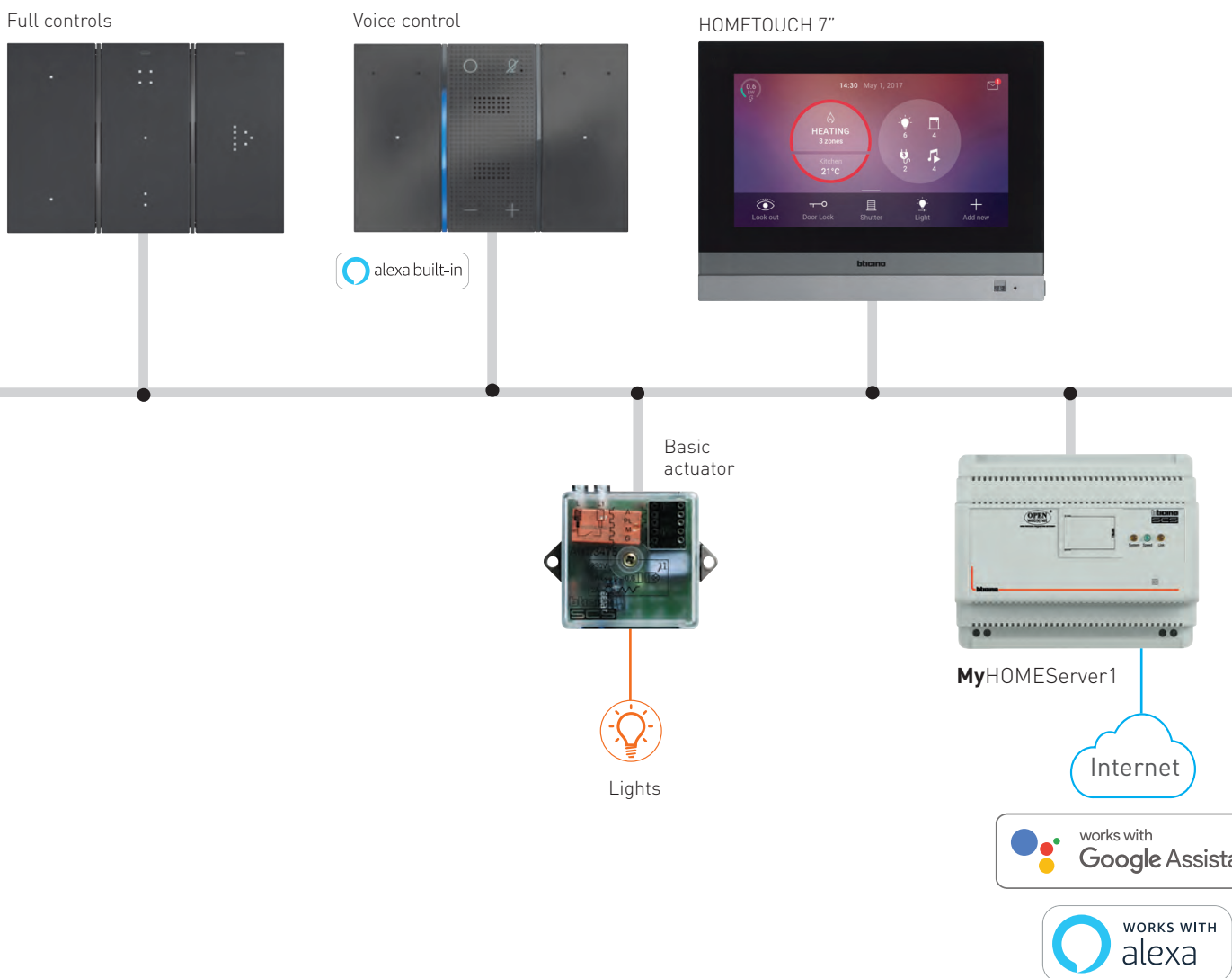
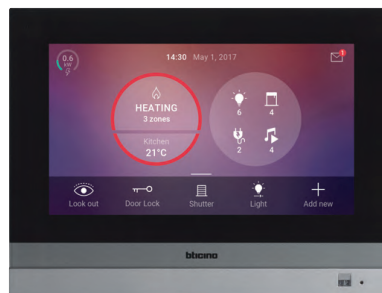

The system functions



TEMPERATURE CONTROL SYSTEM

System for the control of a temperature control system with probes with display, item H/LN4691, used as zone thermostats, and probes item 3454 for the management of up to 99 zones.

MyHOME_Up application allows start up of the system and the check of the operation of the individual devices.

Manageable functions

- temperature display and control using sensor with display, Smartphone with APP and HOMETOUCH touch;
- temperature management in the scenarios created with **MyHOME_UP** APP.

Moreover, if the system is managed using “scenario” type commands, it will be possible to also manage the functions using Amazon Alexa and Google Home voice commands.

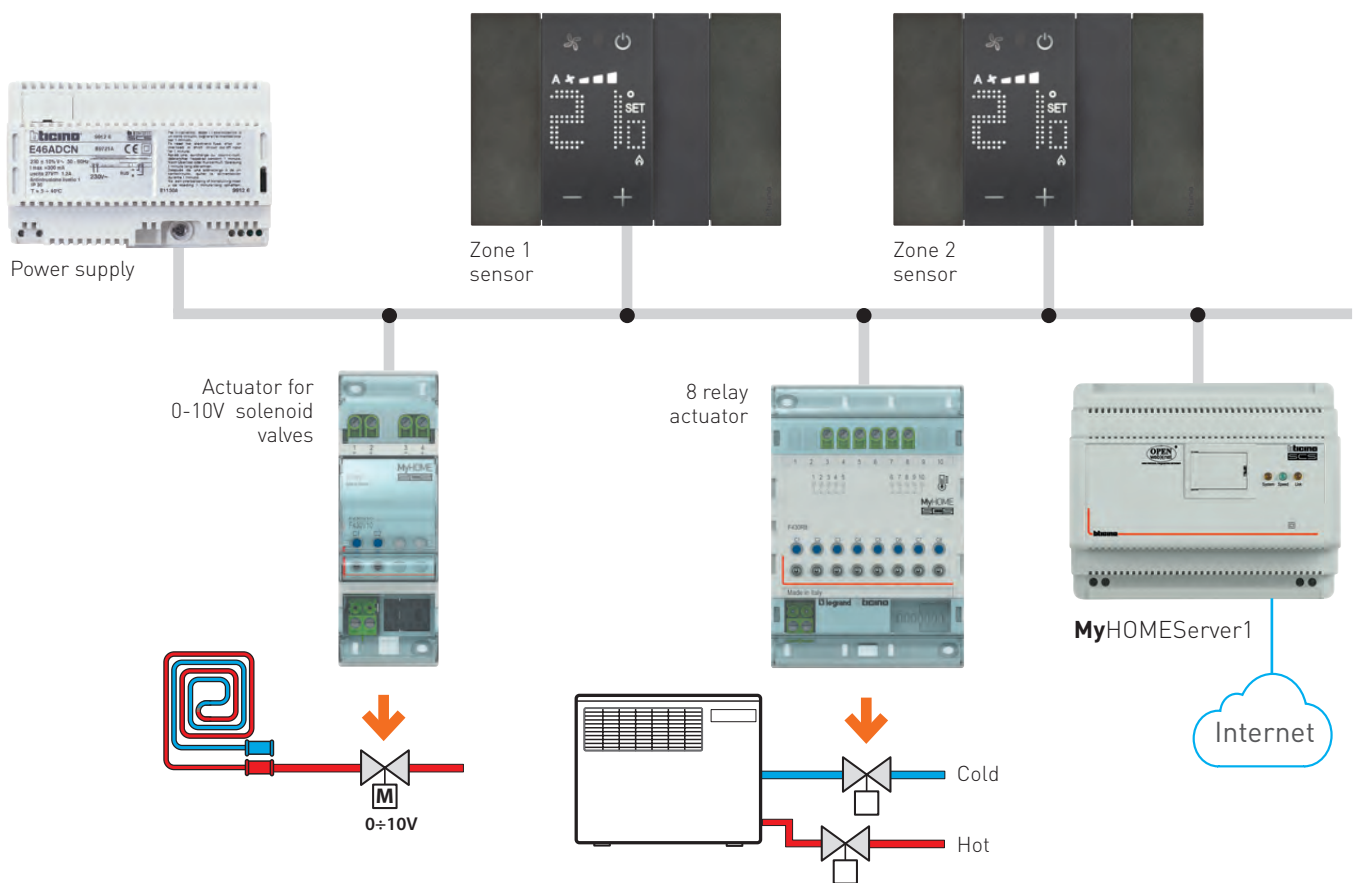



LOAD CONTROL SYSTEM

Using an appropriate control unit, item F521, and actuators, items F522, F523 and 4672N, the load control system manages the maximum power used by the electric system of the home, automatically disconnecting the less important electrical household appliances in case of overload. The value of the power that can be controlled and set in the control unit is between 1.5 and 18 kW.

Manageable functions

- management of up to 63 loads with corresponding disconnection priority, which can be configured based on specific customer needs;
- possibility of reactivating the disconnected load using the HOMETOUCH touch screen and flush mounted devices.

If the overload condition persists, the control unit will disconnect the next least important household appliance.

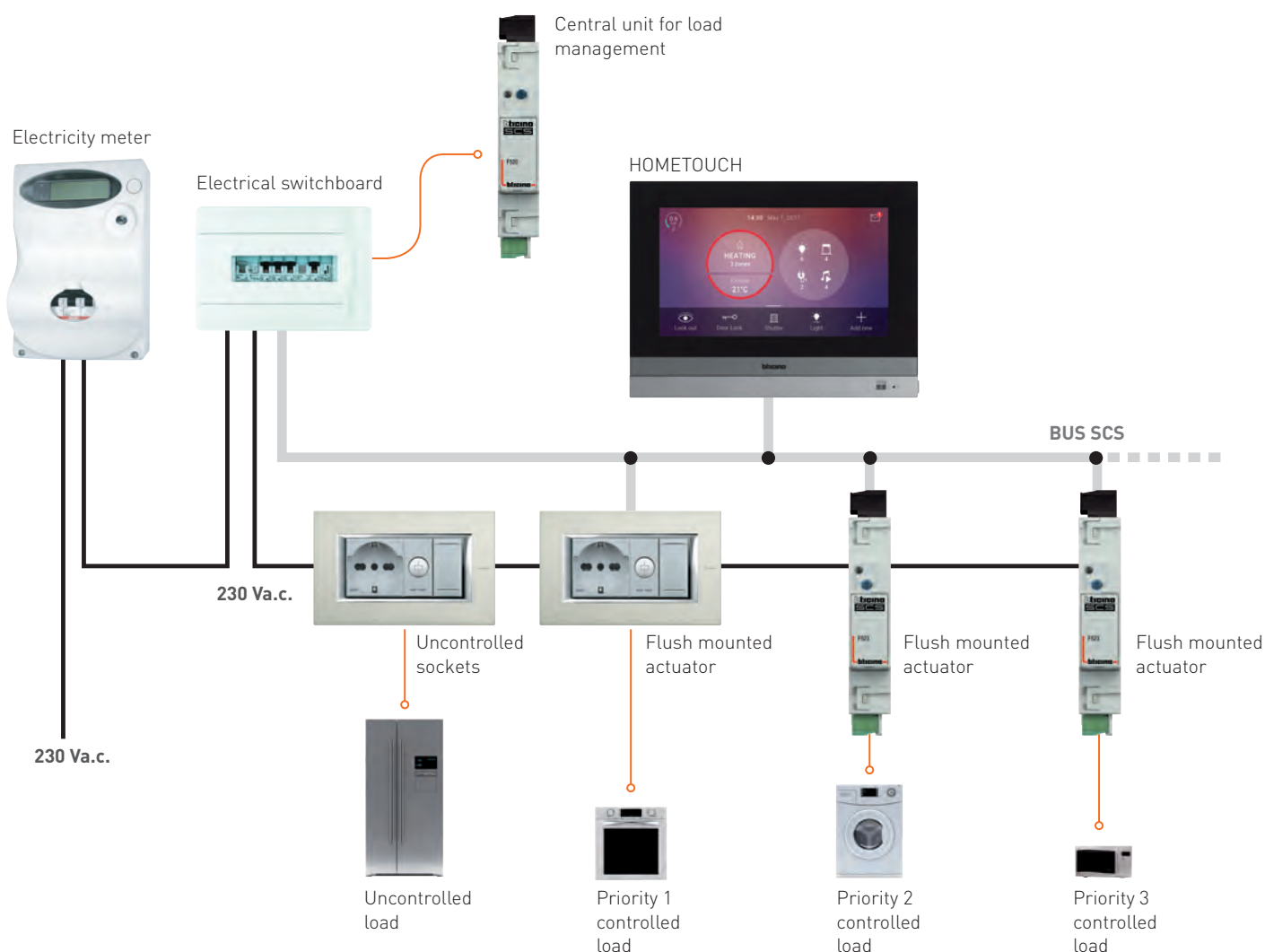

The system functions



CONSUMPTION DISPLAY SYSTEM

System for display by means of energy meters (max. 128) of consumptions of electricity and the production of instantaneous electrical energy.

In the **MyHOME_Up** App the installer must enter the addresses of compatible devices, such as the electricity meter, item F520, and the load control unit, item F521 (consumption display only).

Manageable functions

- the instant electrical consumption/production value can be displayed by the **MyHOME_Up** APP.
- the App can use the consumption value as a condition for activating Smart scenarios.

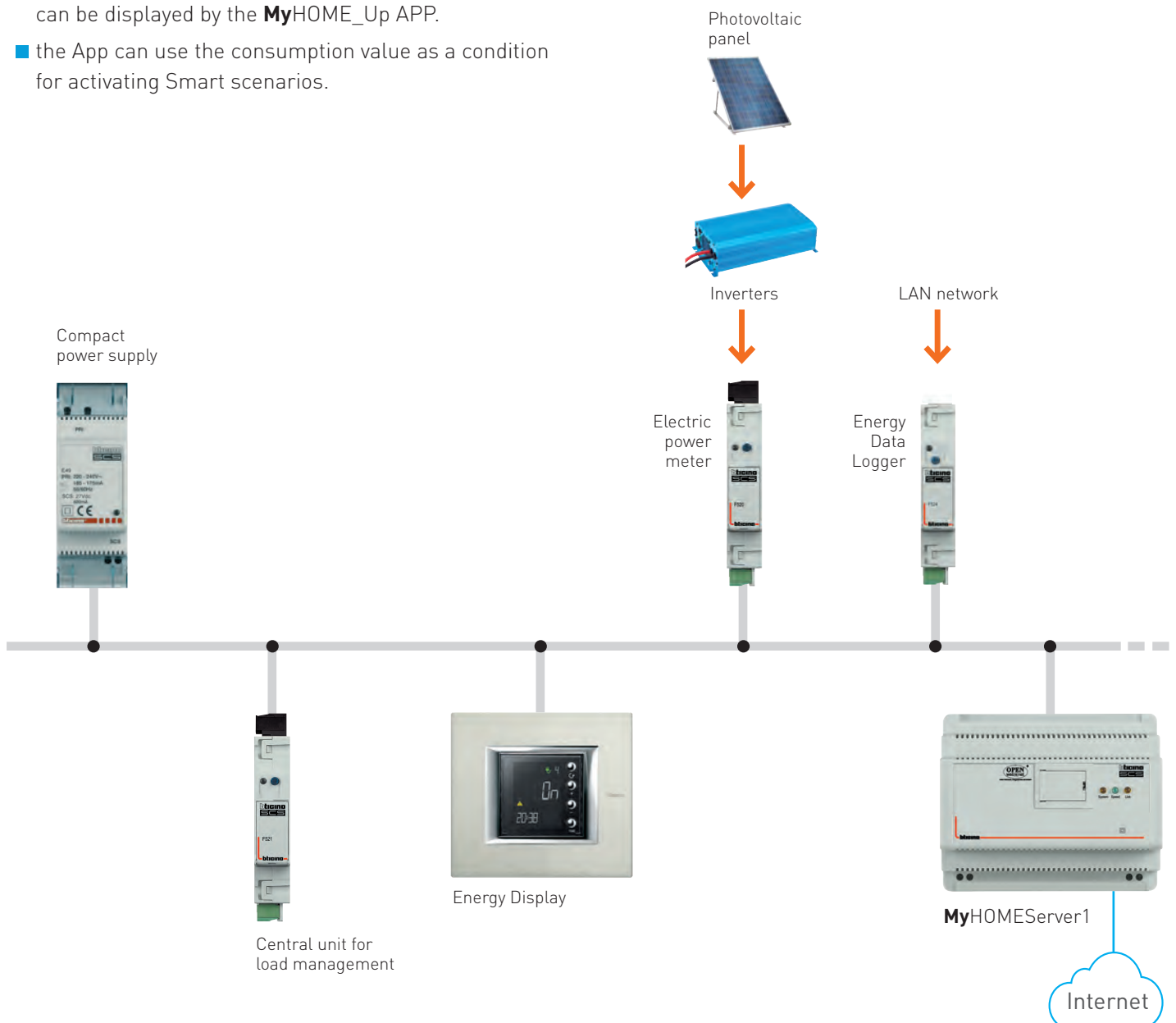



WIRE-RADIO BURGLAR-ALARM system

Burglar alarm system with professional features and flexible solutions, with the following characteristics:

- Management of max. 128 zones;
- Wire solution which can be expanded via radio;
- Use of the IP, GSM and PSTN technologies;
- Local and remote management using the BTicino Home Alarm App and the **MyHOME_Up** App;
- Wide range of sensors for the internal, perimeter and external protection of the home.

Manageable functions

- Control of the areas inside and outside the home.
- Separate management of the protected areas.
- Forwarding of alarm messages with e-mail, SMS and voice messages.
- Creation of Smart scenarios thanks to the functional integration with other components of the **MyHOME_Up** system.

Moreover, if the system is managed using "scenario" type commands, it will be possible to also manage the functions using Amazon Alexa and Google Home voice commands.

WARNING: for the project and the installation see the specific guide: "New burglar alarm system".

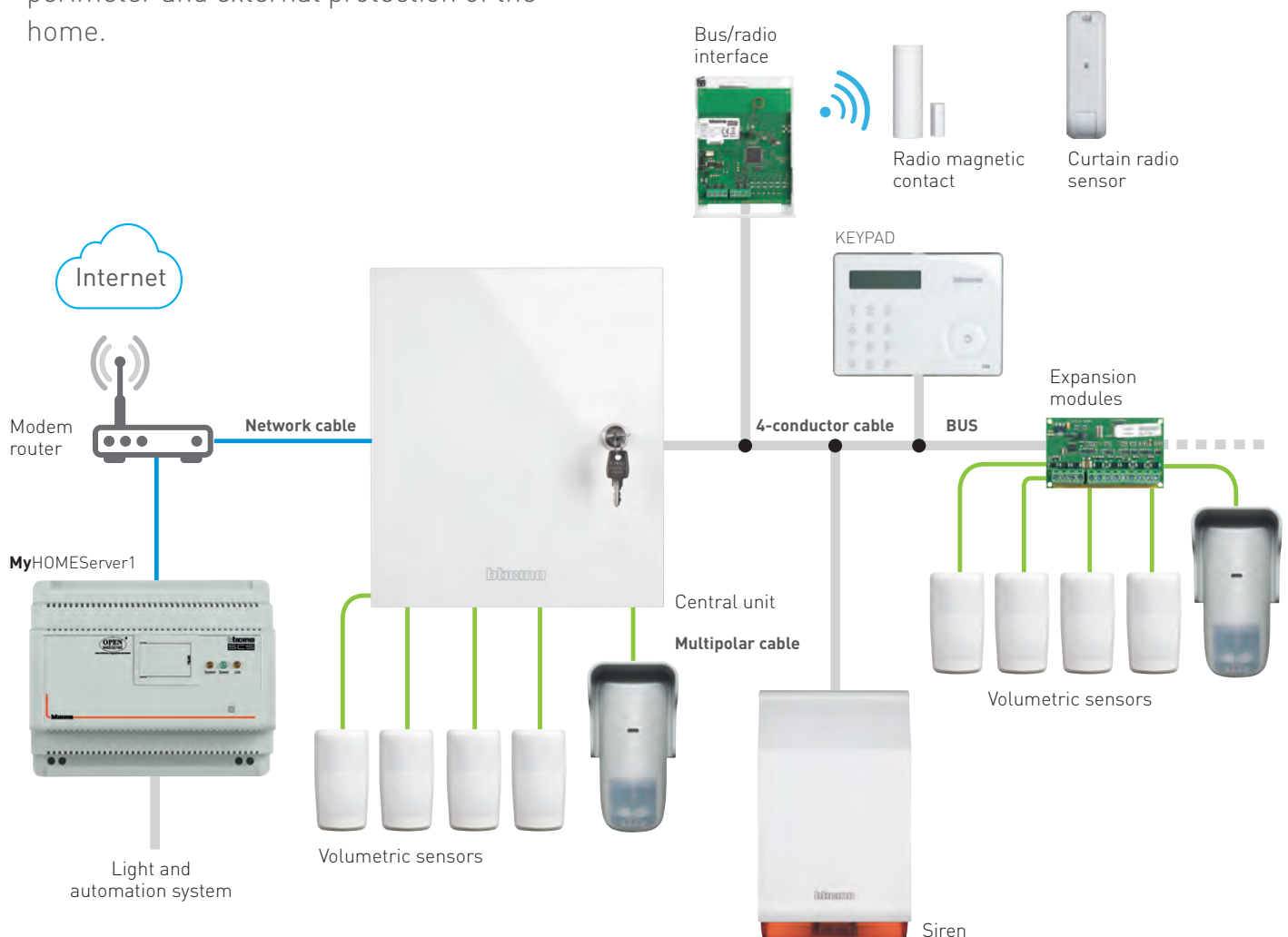

The system functions



NUVO MULTI-ROOM AUDIO SOUND SYSTEM

Multiroom sound system made up of zone amplifier devices (players) connected to the speakers and to the home LAN network with the following features:

- wired solution, suitable for new houses fitted with wired LAN network;
- dual-band wireless (2.4 and 5 Ghz) solution for existing homes or to extend wired systems, in rooms of new homes without wired LAN network.

Manageable functions

- player on/off and volume adjustment;
- source selection (streaming radio, local network or Smartphone mp3 files, etc.);
- creation of scenarios with activation of players in the various zones of the home.

Moreover, if the system is managed using “scenario” type commands, it will be possible to also manage the functions using Amazon Alexa and Google Home voice commands.

WARNING: for the project and the installation see the specific guide “NUVO®: multi-room audio system.”

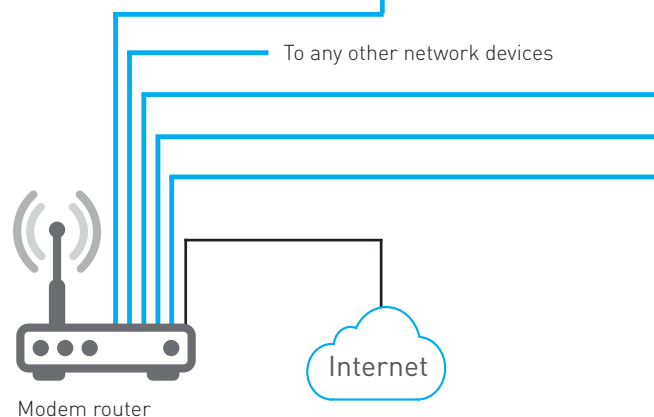
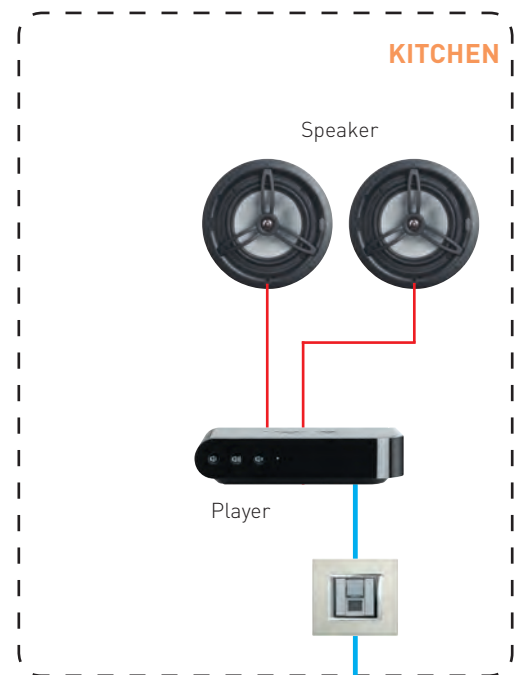

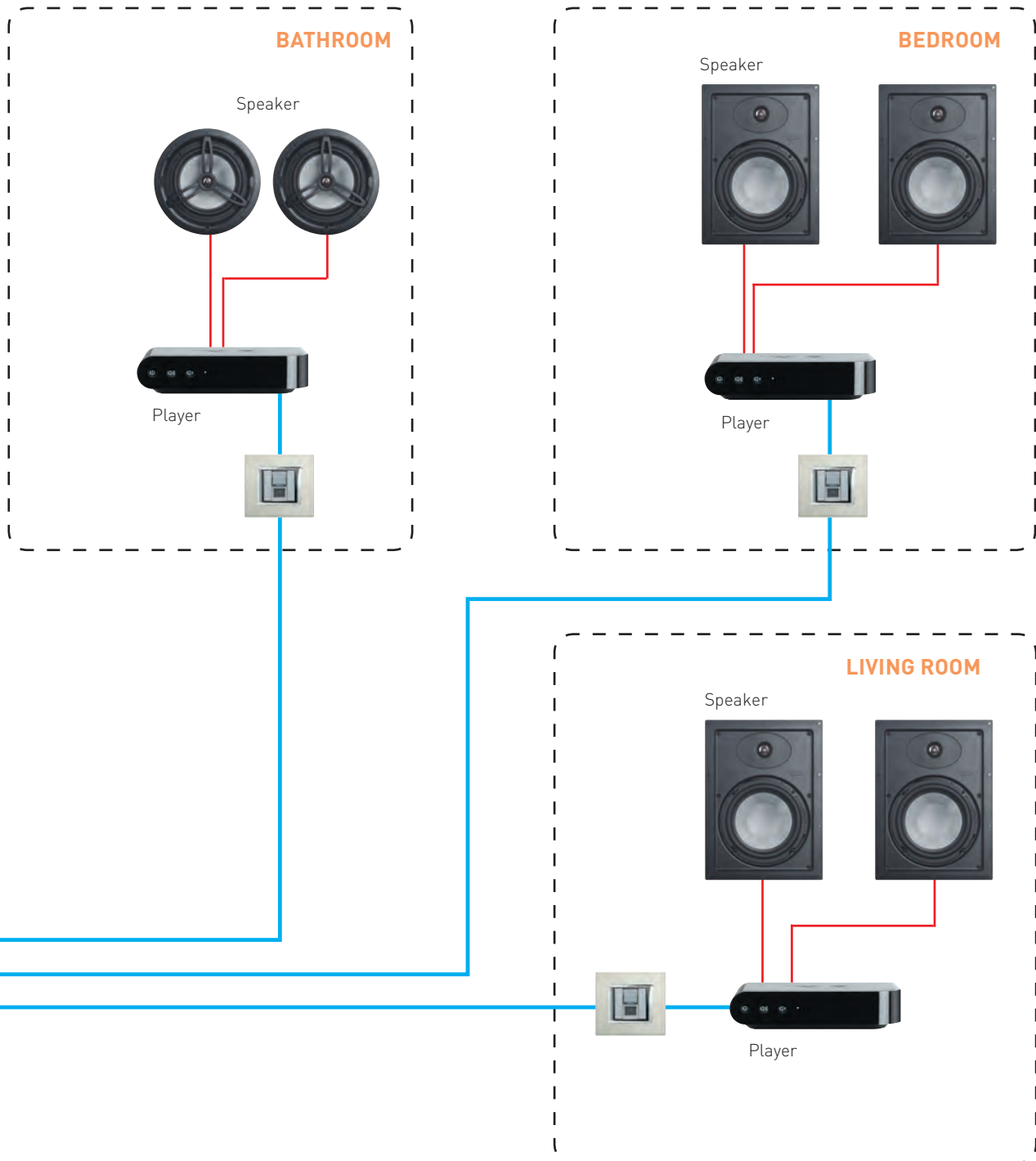

GENERAL FEATURES

Control MyHOME_Up as you wish

MyHOME_Up may be controlled using your voice, flush mounted controls, customised digital controls, the HOMETOUCH 7" touch screen, or the smartphone App, which also allows remote control of the home.

VOICE CONTROL USING THE GOOGLE AND AMAZON VOICE ASSISTANTS



- «Ok Google, switch off all the lights»
- «Alexa, switch the fan on»
- «Alexa, welcome me home»

These are some voice commands for managing lights, controlled sockets and, through scenarios, also shutters, the burglar alarm system, the ideal temperature and the music to stream.

Two solutions for voice control:

- **Digital controls with integrated Amazon Alexa voice assistant**, for flush mounted installation and available in the Living Now range;
- Third-party devices, such as **Amazon Alexa and Google Home voice assistants**.



Google and Amazon voice assistants

In addition to managing home automation functions, it will be possible to interact with the Amazon and Google platforms to request news, weather information, timetables, etc.



Living Now digital control with integrated Amazon Alexa voice assistant

CONTROL WITH MANUAL CONTROLS



Living Now digital controls

Available in the "all key" Living Now range and with capacitive pushbuttons, these devices have LED icons that can be selected using the **MyHOME_Up** App based on the function to manage.

Two versions for each need:

- LIGHT control to manage the lighting (1 or 2 lights, groups and general control);
- FULL control to manage from 1 to 3 light, dimmer, shutter, NUVO audio, load control, scenario and coloured light functions.

The function associated to the control device and the corresponding icon can be changed at any moment by the installer during the start up of the system and also by the user using the **MyHOME_Up** application.

In addition, the device may also be expanded for new functions, and moved around the home without any need for rewiring.



Controls with silk-screen printed key covers

The range of manual control devices also includes products of the Living Now, Livinglight, Axolute and Matix ranges, to be completed with key covers with silk-printed function symbols. Also for these controls the association of the functions is completed using **MyHOME_Up**.



GENERAL FEATURES

Control **MyHOME_Up** as you wish

CONTROL WITH SMARTPHONE AND **MyHOME_UP** DEDICATED APP

This is done using the specific **MyHOME_Up** App installed in the Smartphone of the user. The connection to the system takes advantage of the MyHOMEServer1 gateway connected to the home Wi-Fi network and the Internet through the modem router.

No application configuration by the user is required. All the devices to manage are in fact already recognised when the system is put into operation, which is done by the installer using the same App installed in the own Smartphone.

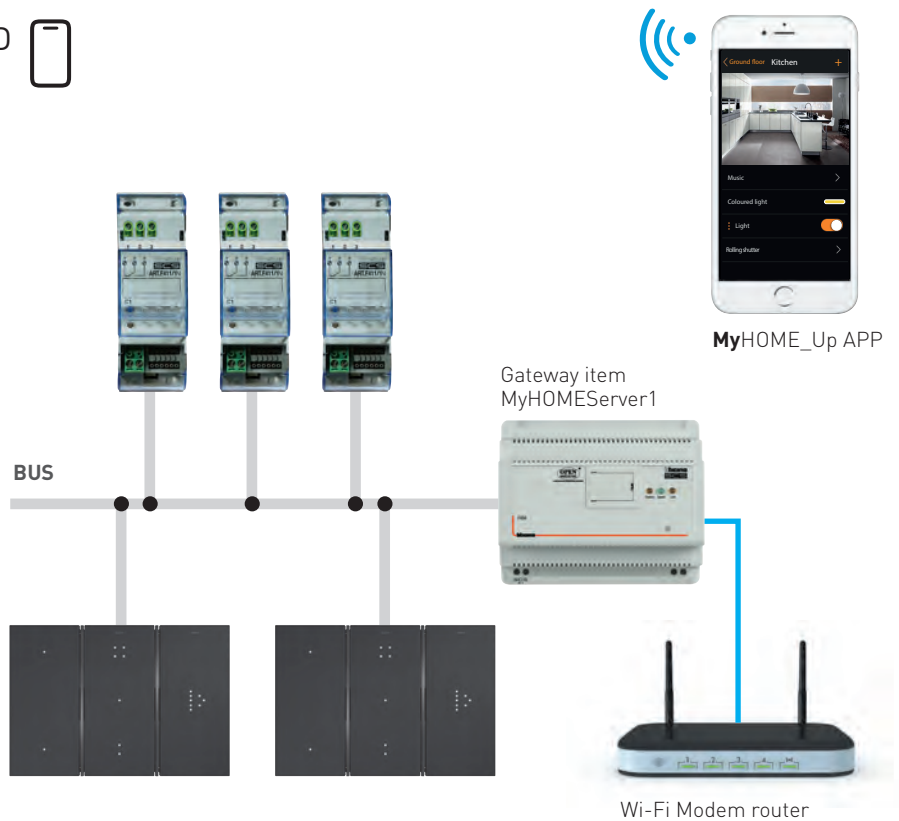

With **MyHOME_Up** application it will be possible to:

- control the lights;
- control the shutters;
- adjust the temperature;
- control the controlled socket;
- display the instantaneous consumptions of the loads (washing machine, cooker etc.);
- control the devices of other brands (LIFEX, Philips Hue lamps etc...);
- open door locks;
- listen to the music from the Nuvo multiroom sound system;
- create and manage scenarios;
- switch the BTicino Burglar Alarm system on/off using the insertion scenarios, activate partitions, exclude zones and display events and faults.

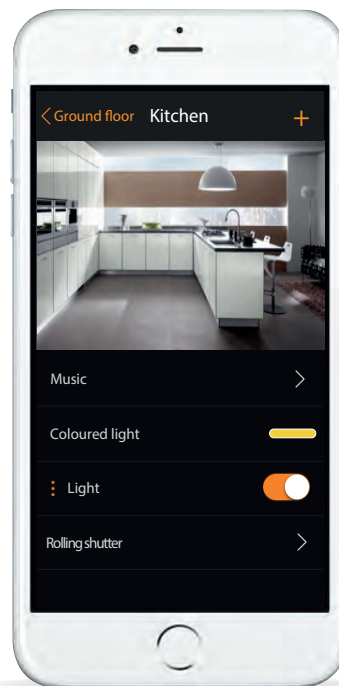

MyHOME_Up is available free for iOS devices from App Store and for Android devices from Play Store.



CONTROL WITH HOMETOUCH TOUCH SCREEN



Thanks to the simple and immediate interface, with this touch device - item 3488 (black) and item 3488W (white) -, users will have all the functions of the **MyHOME_Up** system at their fingertips:

- Lighting;
- Shutter automation;
- Temperature control;
- Nuvo multi-room sound system;
- Scenarios;
- Function possible thanks to the integration of third-party devices and systems.

In addition, HOMETOUCH also integrates the BTicino video door entry system and can be used as connected internal unit for the handling of calls both locally and from the Smartphone, using the free **DOOR ENTRY** App for HOMETOUCH.



Temperature control status notification

Automation and audio status notification

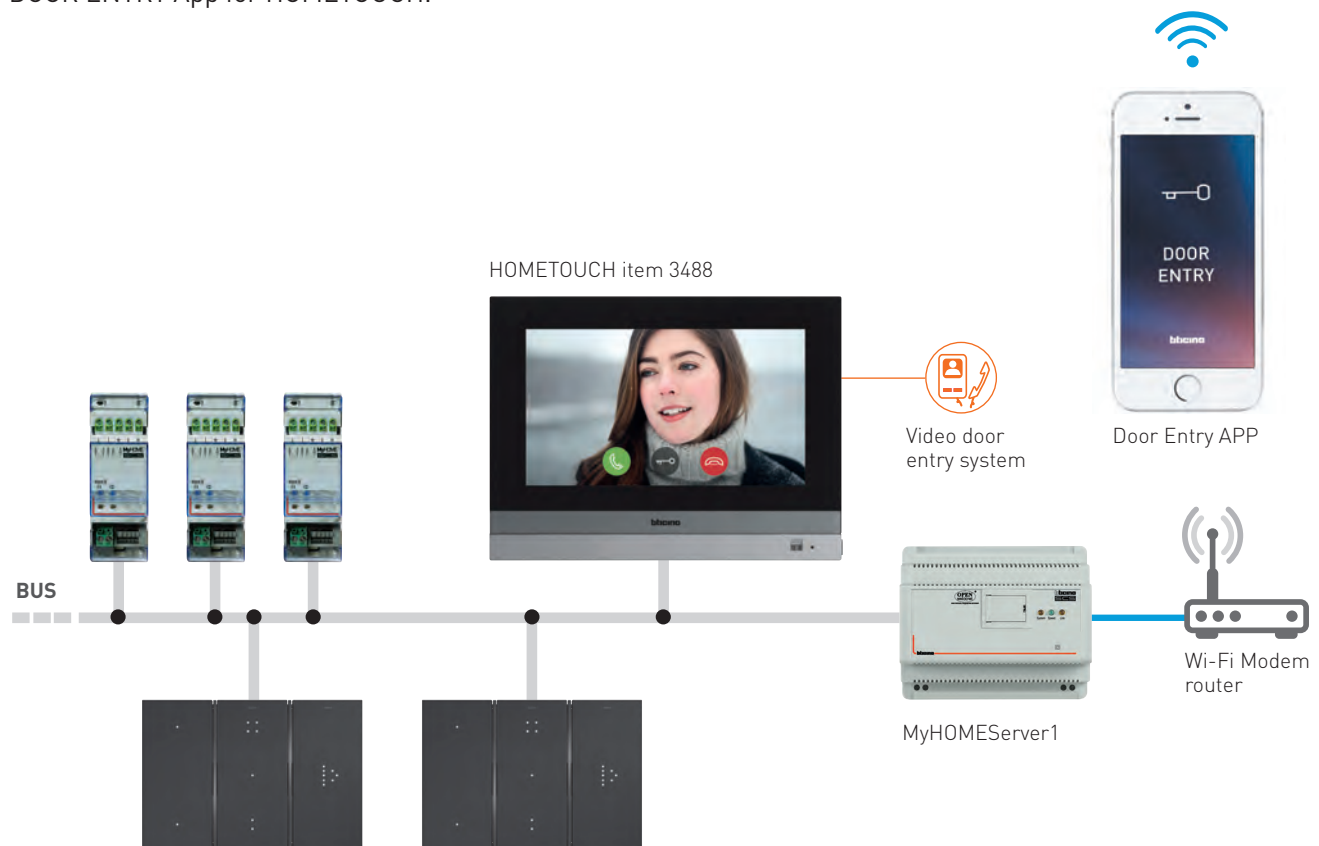

HOMETOUCH item 3488

Video door entry system

Door Entry APP

MyHOMEServer1

Wi-Fi Modem router

GENERAL FEATURES

Discover how easy it is to start the system.

The putting into operation of the system and the definition of the functions with the command-actuator association is easily completed using the **MyHOME_Up** App and the MyHOMEServer1 gateway connected to the BUS and the Internet network.

During system operation, the gateway allows users, both inside and outside the home, to manage the functions and customise their scenarios using their own Smartphone and the **MyHOME_Up** App.

The putting into operation of the system only requires a few steps:

- 1** **Connect** all the devices and the **MyHOMEServer1** device to the BUS system. The self-learning procedure will be completely automatic. After a few minutes all the actuators will be working perfectly with default modes.



MyHOMEServer1

- 3** **Start** the App which will connect to the system using Access Point.

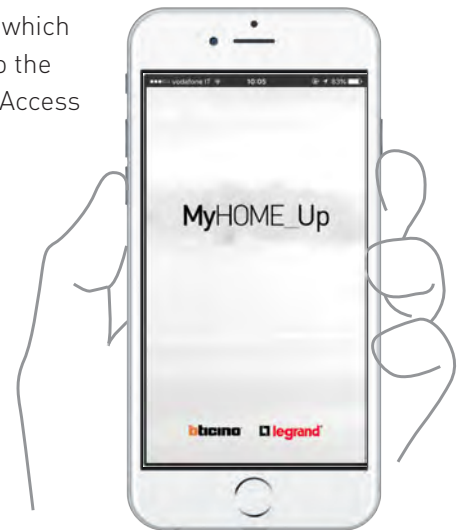

- 2** **Install MyHOME_Up** which can be downloaded free from Android and iOS stores, on your smartphone or tablet.

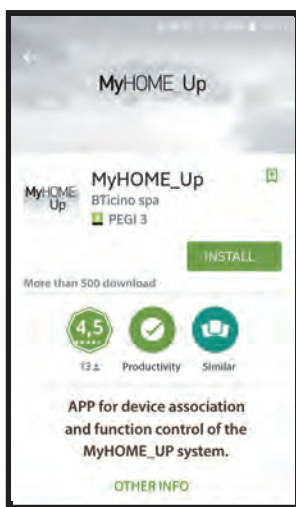

- 4** After logging in **select** the room of the home and the function to be defined.

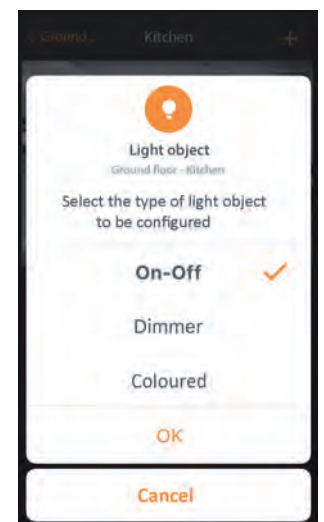
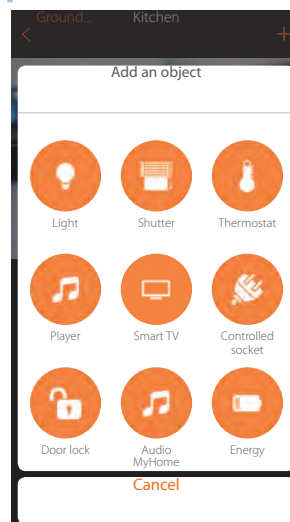

5

Press the pushbuttons of the devices which perform the function; if it is difficult for you to reach the devices you can easily select them from the list of those which MyHOME_Up has found on your system.

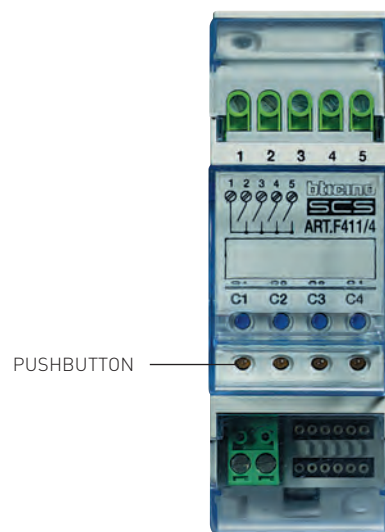
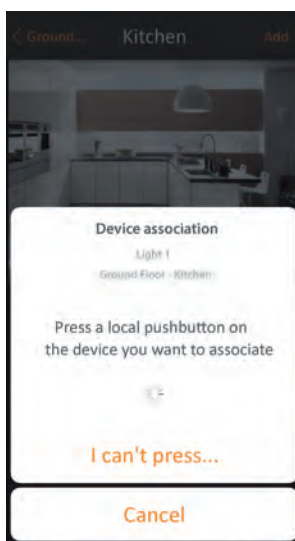

6

Associate all the control devices by pressing their pushbuttons. At the end of the association all the controls selected will be working perfectly. You will also have created the graphic object to check the function from the mobile device.

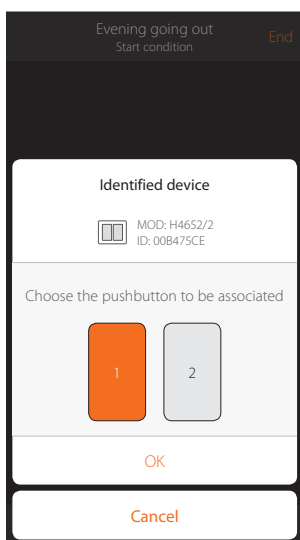

PUSHBUTTON



Your work is finished.

You and your customer can manage the function set.

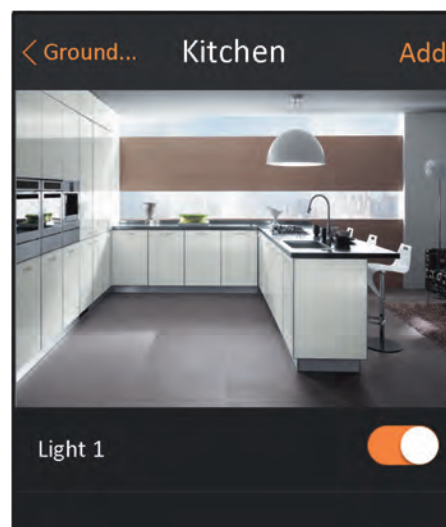

WARNING: the list of energy Management and Automation devices that can be associated using the MyHOME_Up App is available in the Appendix pages at the end of the Guide. Any other unlisted devices can be configured using the MyHOME_Suite software discussed in the "Software and Services" chapter

GENERAL FEATURES

An open system

MyHome_Up is an open system that can be easily integrated, without requiring any system changes, with the best third-party technologies, systems and devices in three different ways.

1. NATIVE INTEGRATION WITH MyHOMEServer1:

- simple solution, as the integration drivers are already installed in the device by default;
- the association between **MyHOME_Up** and third-party devices is completed using the **MyHOME_Up** App.

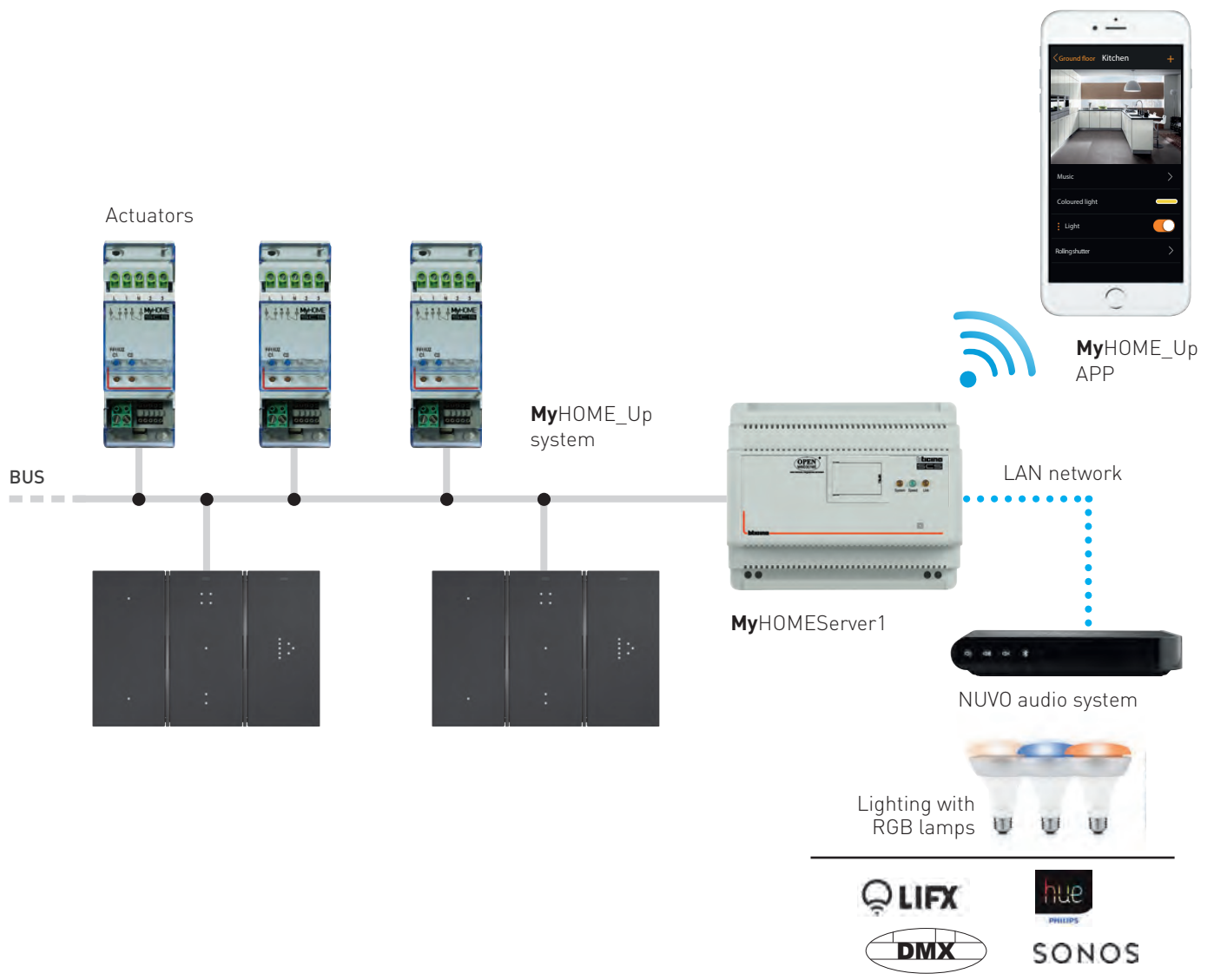

2. INTEGRATION WITH DRIVER MANAGER ITEM F459:

- Specific device for the use of integration drivers purposely created based on the characteristics and functions of the system to integrate (for example to integrate **MyHOME_Up** with HVAC Samsung and Mitsubishi systems, etc.);
 - scalable and customisable solution for the realisation of functions not available with the **MyHOME_Up** system;
- Reliable operation thanks to local interoperability.

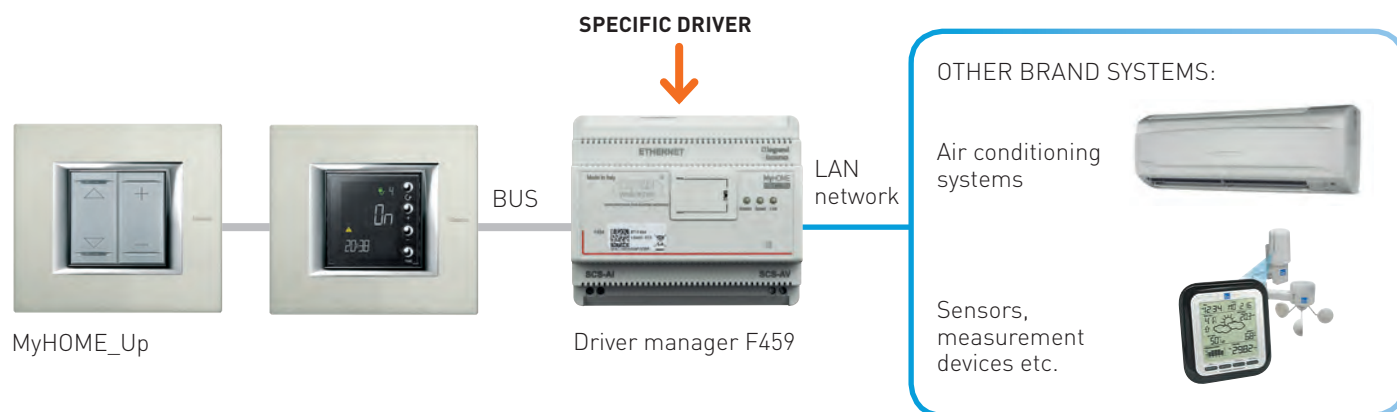

3. INTEGRATION THROUGH THE USE OF APPLICATION PROGRAMMING INTERFACES (API).



API integration can be made in two ways:

- interoperability through IP platform sharing of different languages (locally and through the cloud).
- interoperability through IOT Cloud platforms, such as Artik Samsung and similar.

These solutions are available and developed by the “Works with Legrand” integration platform.

For the details visit bticino.com site

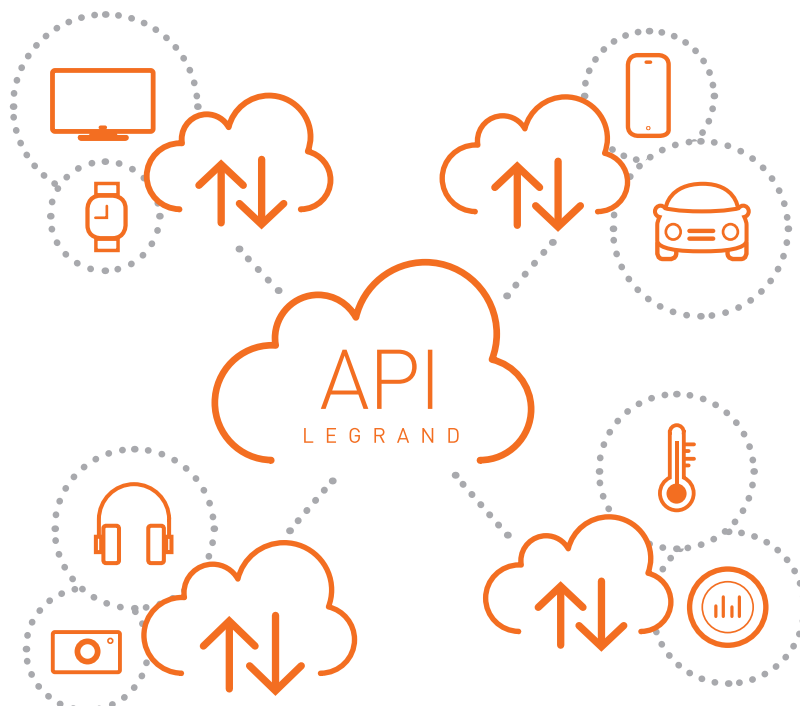

For more information please visit the <https://bticino.com> site

GENERAL FEATURES

An open system - the scenarios

The integration among the different functions of **MyHOME_**Up and any third-party systems allows to create and manage the **Scenario** function for the simultaneous activation of several devices.

For example, the switching on of certain lights at a specific intensity level, the raising of the shutters to a certain height, the switching on of specific music to ensure the comfort of the user in a specific situation.

MyHOME_Up APPLICATION



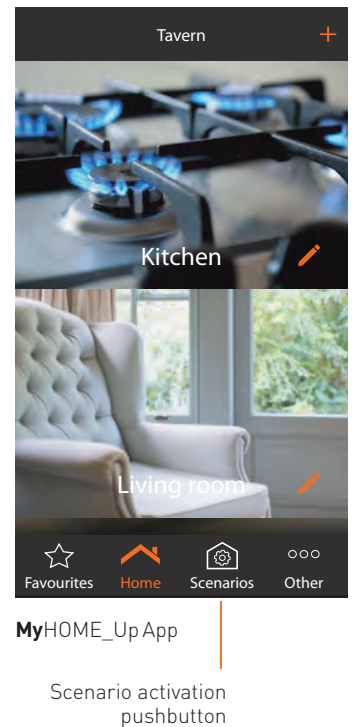



The creation and management of scenarios (up to 50 per system) can be easily completed by users, using their Smartphones and the **MyHOME_**Up App.



Type of scenarios that can be made with MyHOME_Up:

It is possible to set two types of scenarios:

- with manual activation.
- with automatic activation at certain times or days, based on states and conditions occurring in the system, such as:

-  Touch a pushbutton
-  An object changes status (e.g. a rolling shutter goes up)
-  A Burglar Alarm system partition changes status when an insertion scenario is switched on
-  The weather conditions set occur
-  I am leaving or approaching the house
-  It is 8 am from Monday to Friday

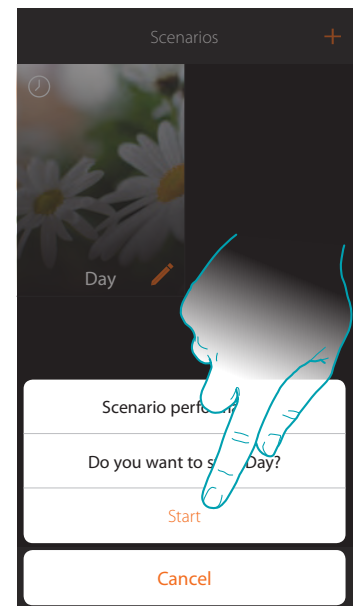
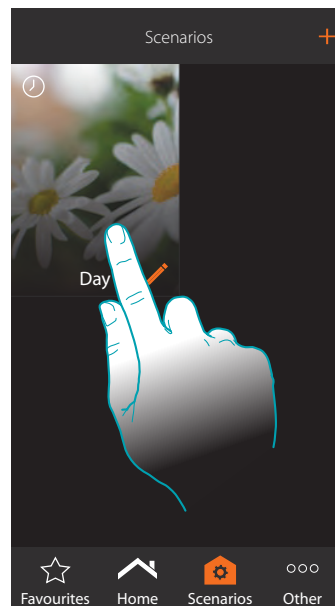



CONTENTS

MyHOME_Up – Project guidelines

General features	22
Preliminary project and system layout.	24

GENERAL FEATURES

Functional diagram of a MyHOME_Up system

The procedure for the creation of a **MyHOME_Up** system is similar to that for a traditional system. Power supplies and other DIN modular devices must be installed in a general panel. All the others must be flush or wall mounted. However, differently from traditional wiring, in this case the wiring will be using a grey 2 wires BUS cable for **MyHOME_Up** devices, and a white one for video door entry devices.

It will be necessary to install a wired and Wi-Fi network connected to the Internet, for the integration of **MyHOME_Up** with the burglar-alarm system, with the NUVO audio system, and with any installed third-party devices. Internet connection is also required for the remote control of the system using a Smartphone.

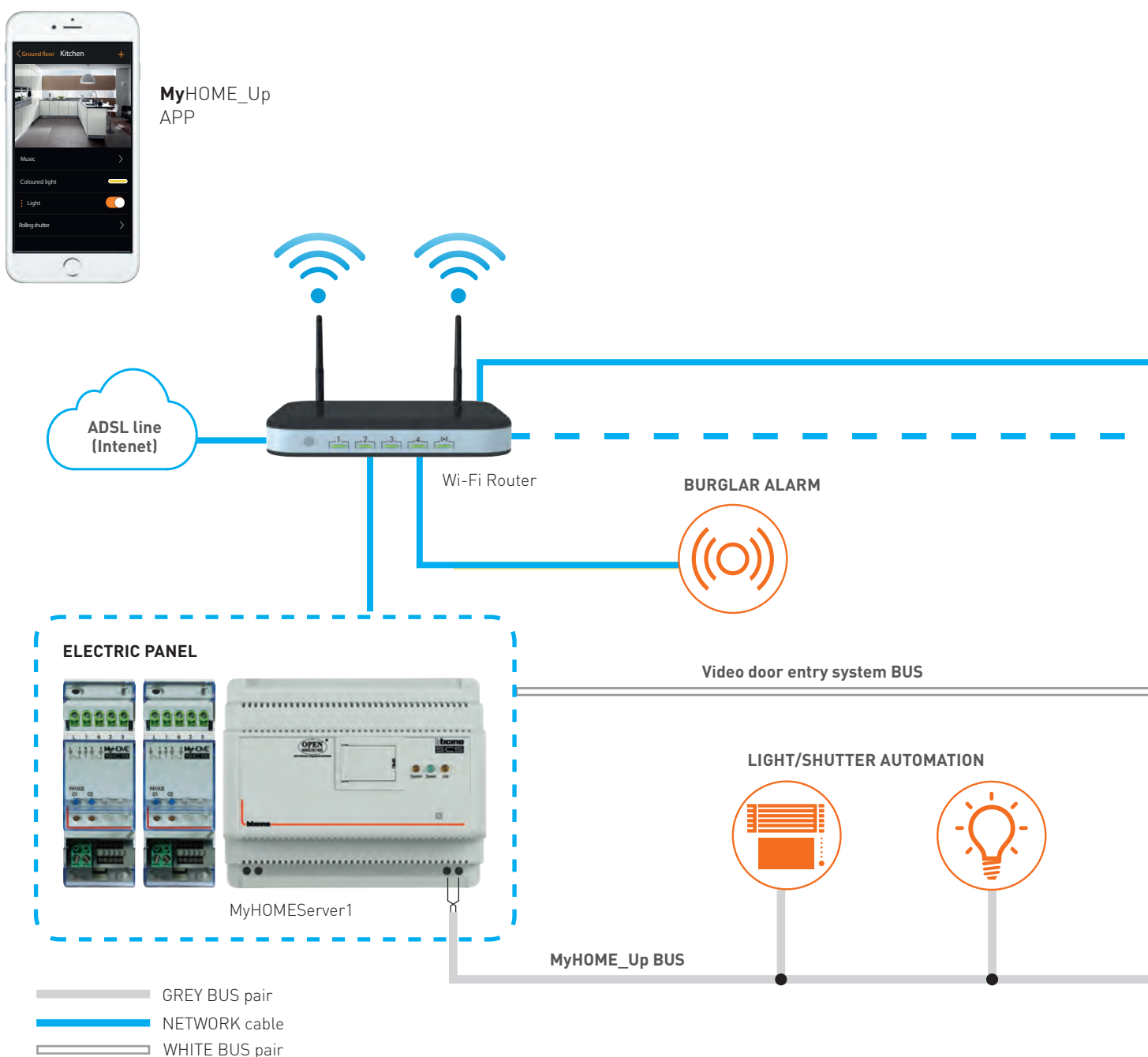

The **MyHOMEServer1** device is at the heart of all the integrated system. When putting the system into operation, it is used to recognise and associate to each other all the installed devices. It also acts as a gateway, allowing the user to control the functions of the system and of third-party products using the HOMETOUCH touch screen, Amazon Alexa or Google Home voice commands, or remotely using the Smartphone and the **MyHOME_Up** App.

As it can easily be seen in the diagram, some MyHOME_Up system components are integrated with each other by sharing the BUS cable, while others, such as the Burglar Alarm system and the NUVO audio system, third-party products (for example coloured lamps) and voice assistants, are integrated with the system through the wired or wireless domestic LAN network connection.



The installation of a BUS system

FEATURES OF THE MyHOME_UP WIRING

The **MyHOME_Up home-automation** system uses BUS installation technology: all the devices are connected "in parallel" by means of a two-conductor wire, used to transport the information and low-voltage electrical power supply (27 V d.c.).

As can be seen from the diagram given below, relating to the lighting system, the power line for the load power supply is free of the control line and the control line is independent of the functional wiring.

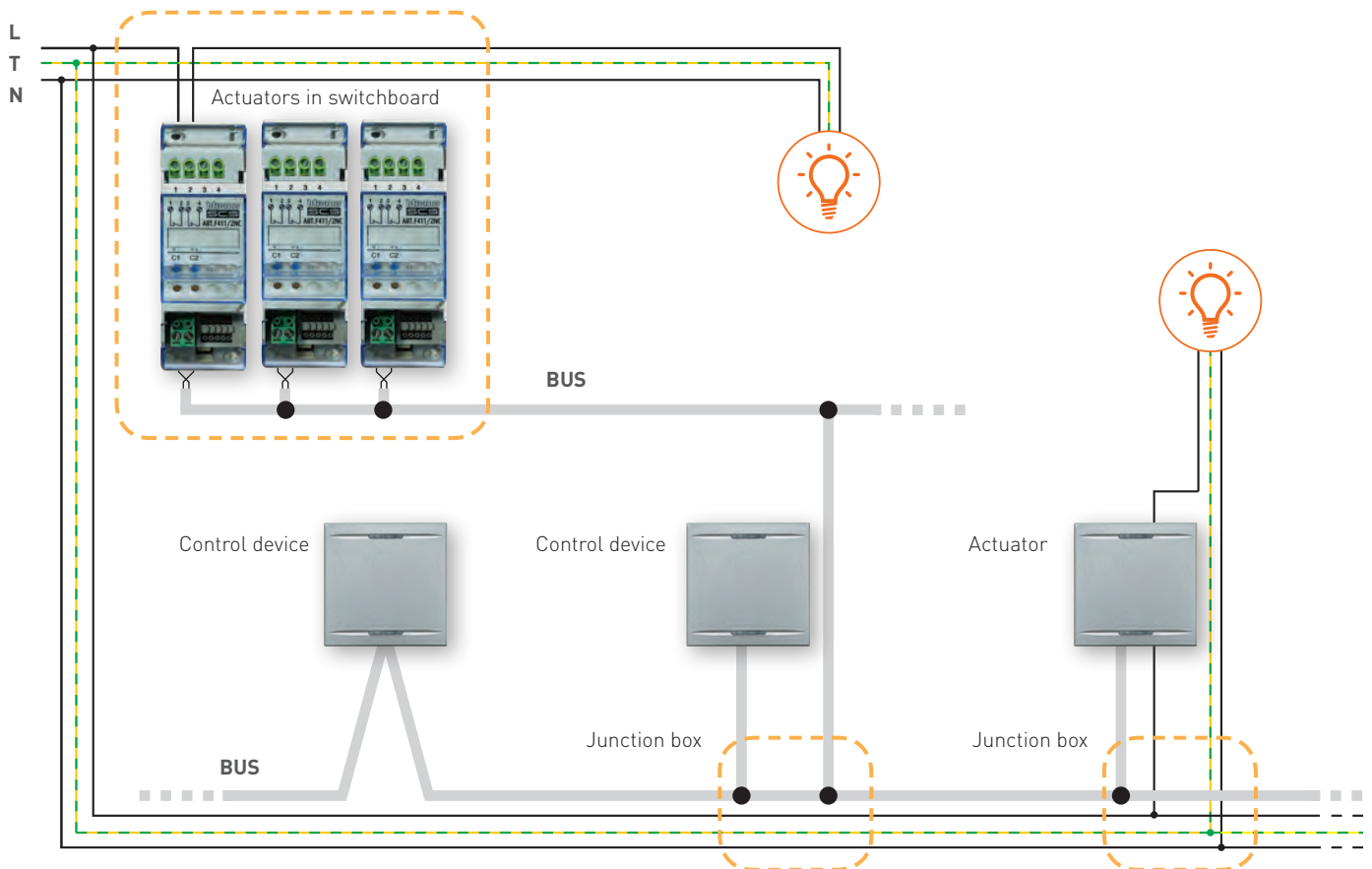

MAKING THE WIRING

The wiring distribution can be made with:

- **Free structure**
- **Star structure**

The selection must be made in relation to the installation needs, the functions required, wall limitations, refurbishments or new buildings.

Wiring with free structure

This wiring is usually used in traditional distributions. If the building already has energy system conductors with suitable diameter they can be used to insert the BUS pair because it has an isolation voltage of 300/500 V.

These indications also apply to the installation of the junction boxes which must be arranged in suitable number and positions to the "in parallel" connection of the various stretches of pair.

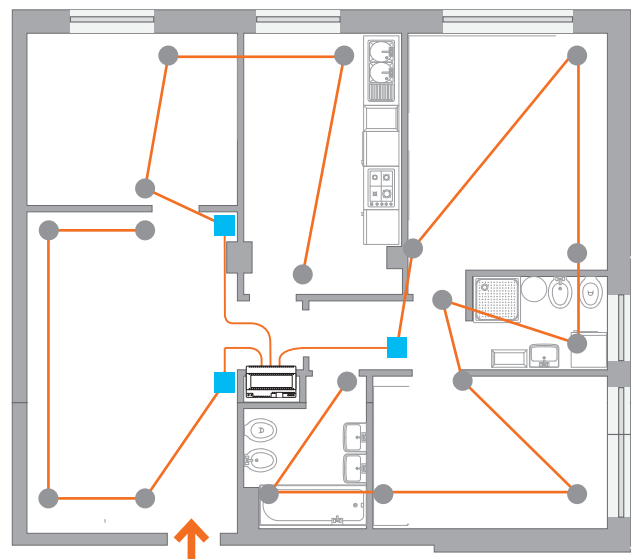

Wiring with star structure

This wiring should be used when the system will be integrated with the data transmission, video door entry, CCTV, sound, telephony and TV/SAT systems in a single conductor.

The wiring structure is made up of a central point called the "star centre" made with a switchboard or an electrical board in which all the peripheral branches of the various wirings converge.

The conductors must be installed providing junction boxes every 10 metres for the pulling of the wires.

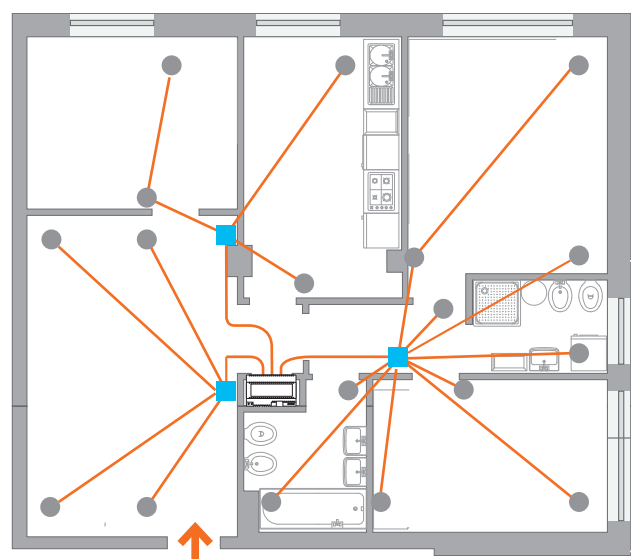

The installation of a BUS system

CHOICE OF THE WIRING CABLES

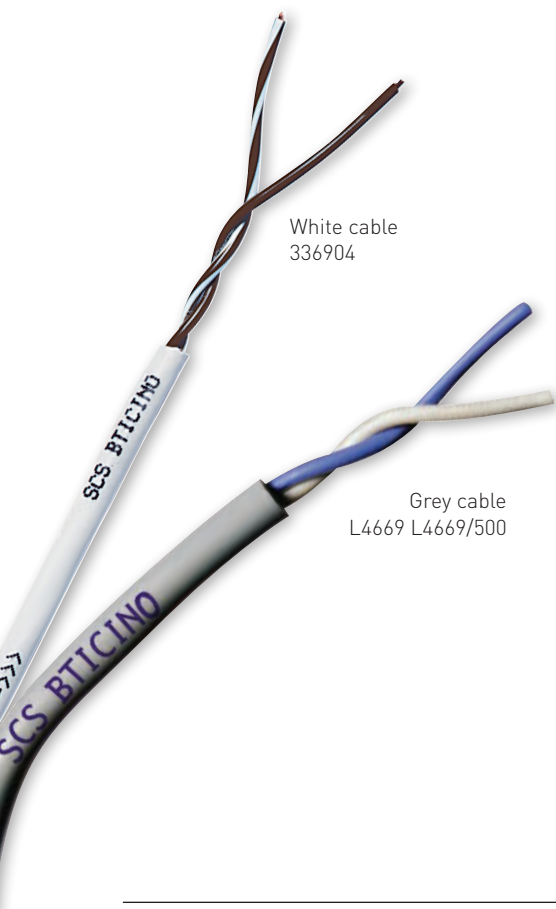

BTicino cable 336904 and 336905

Cable consisting of 2 twisted conductors with 0.50 mm² section for each conductor. It can be used for video door entry systems, and also for MyHOME_Up systems when underground installation is required, running inside appropriate conduits, as it complies with the requirements of the IEC 20-11 standard. The cable item 336905 is a low toxicity cable, halogen-free, to be used where fire safety is particularly critical.

Technical features

- SCS sheathed pair made up of 2 flexible conductors with unshielded twisted sheath
- Insulation voltage: 400 V
- In compliance with the EN60811, EN50289, EN60228, 50265-2-1, EN50395, EN50396 standards
- Coil length: 200 metres

BTicino cable L4669

This cable is used for BUS systems in the following applications: Automation, Energy control and Temperature control. Thanks to the BUS cable with 300/500 V insulation and the cover for the protection of the clamps with which all devices are equipped, BTicino systems can also be installed in the same boxes and conduits as the power line (230 Vac).

Technical features

- SCS sheathed pair made up of 2 flexible conductors with unshielded twisted sheath
- Insulation voltage: 300/500 V
- In compliance with the CEI 46-5 and CEI 20-20 standards
- Coil length:
 - 100 metres (item L4669)
 - 500 metres (item L4669/500)

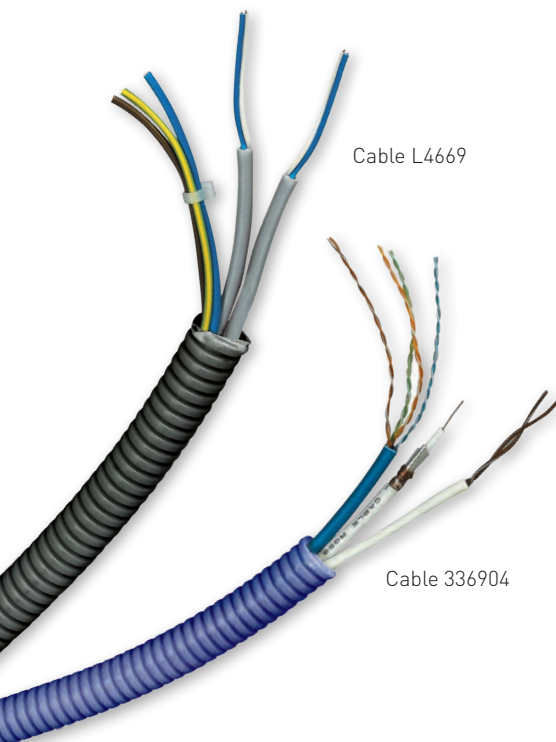

Cable coexistence

Although the construction of the cables guarantees 300/500 V electrical insulation, there is no guarantee of immunity from disturbance, which may occur when the cable is installed inside the same conduits as the 230 V power supply cables. These types of installation are strongly NOT recommended.

However, in case of refurbishment, the grey cable, items L4669 and L4669/500, and the white cable, item 336904/..5, can be routed inside the same conduits of the traditional electric system. This solution ensures significant savings, both in terms of masonry works and financial.

The video door entry system and sound system **WHITE BUS** can be routed inside the same conduits of the data transmission, telephone and TV-SAT cables. However, it must be kept separate from the power line.

The separation of the power lines from the signal lines **MUST** also be ensured inside the junction boxes and the electric panel. Therefore, attention must be paid to the point of entry of the conduits in junction boxes and the electric panel.

The following table can help to select the type of cable to use based on the MyHome application.

		MYHOME APPLICATIONS						
		COMFORT			SAVING	COMMUNICATION		CONTROL
		Lighting	Automation	Temperature control	Energy Management	Video door entry system	Data network	Video Web Server
	BTicino 336904 and 336905 L4669HT (white)	● (*)	● (*)	● (*)	● (*)	●		●
	BTicino L4669 and L4669/500 (grey)	●	●	●	●	●		●
	BTicino L4668CM UTP 5	●	●	●		●	●	●
	Multi-pair UTP 5E BTicino C9881U/5E C9882U/5E						●	●

● Cables recommended by BTicino (meeting the installation regulations)

● Cables that may be used (for every system check against the installation regulations)

NOTE (*): Mandatory for the underground sections of the individual systems

Light and automation system

POSITIONING OF DEVICES (POWER SUPPLIES AND ACTUATORS) DEPENDING ON LOCATION

Comply with the following recommendations:

- **1, 2 or 3 rooms:** group the DIN actuators together in the electric/home automation panel, and distribute flush mounted actuators.
- **more than 3 rooms:** group together and, when convenient, distribute the actuators inside junction boxes. A “flush mounted” actuator should be preferred for the shutters.
- **several floors:** install an electric panel for each floor, for grouping the actuators together. Where it is convenient to install the actuators in junction boxes.

Centralised installation: the actuators are grouped together in the electric panel

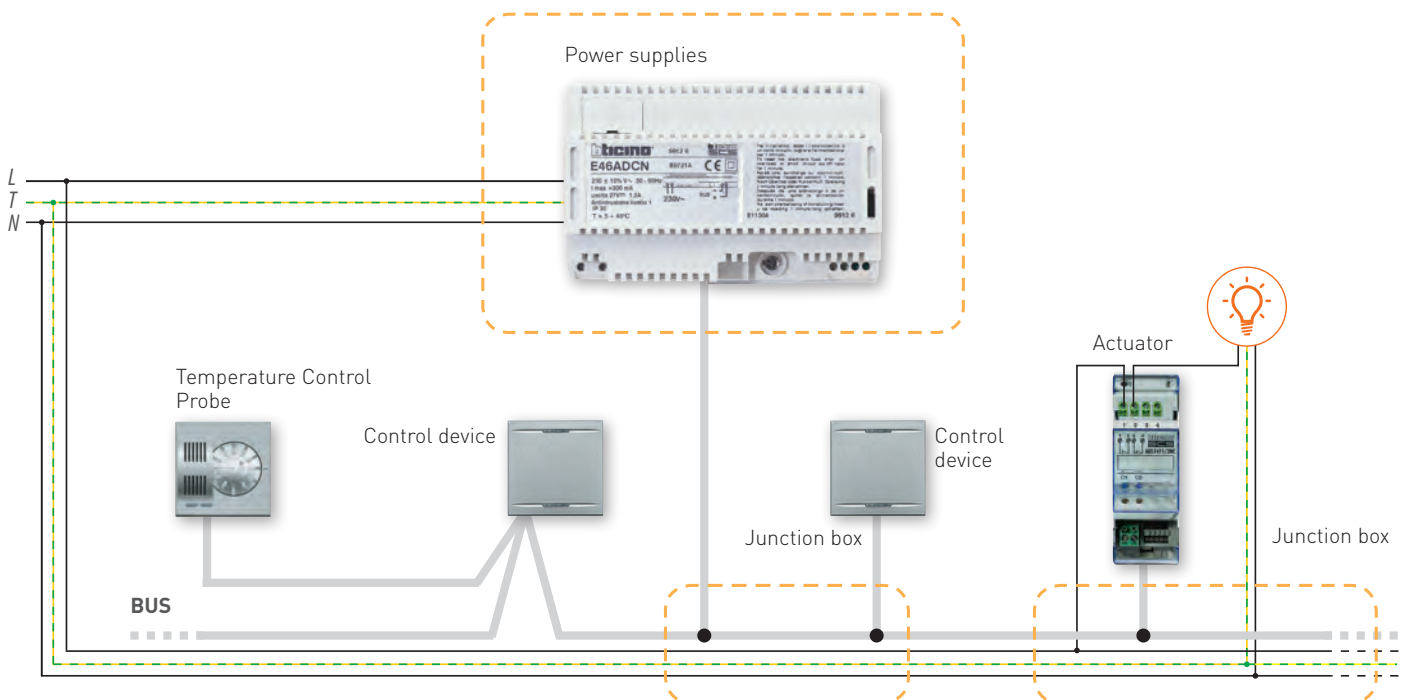
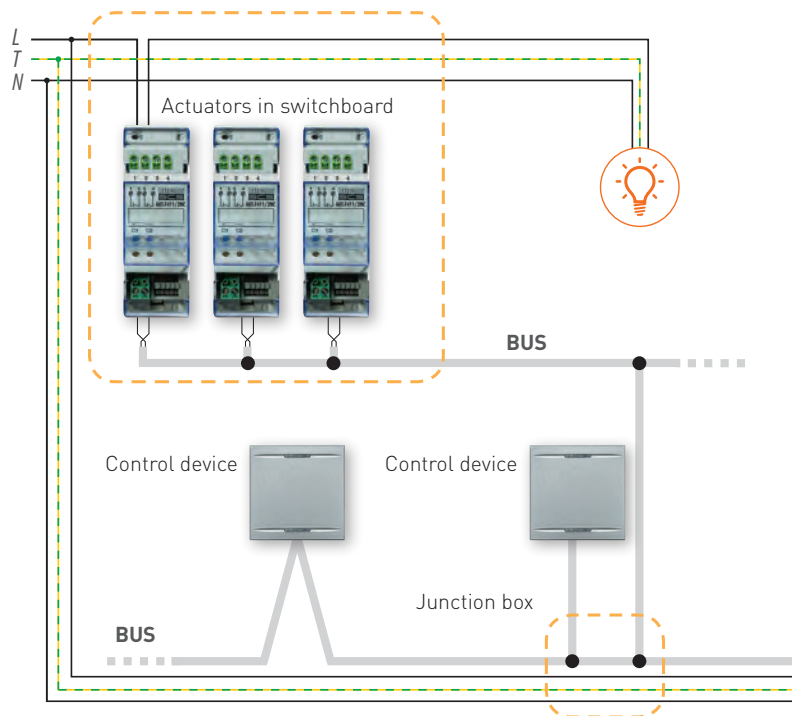

Distributed installation: actuators and control devices are installed in device or junction boxes.

Temperature control system

The design of a temperature control system must be completed with the help of the temperature control system/water system designer, in order to allow for the following requirements:

SEPARATION OF THE SYSTEM INTO ZONES

To allow zone temperature control of the home, the solenoid valves for the management of each individual zone must be installed on the distribution manifold.

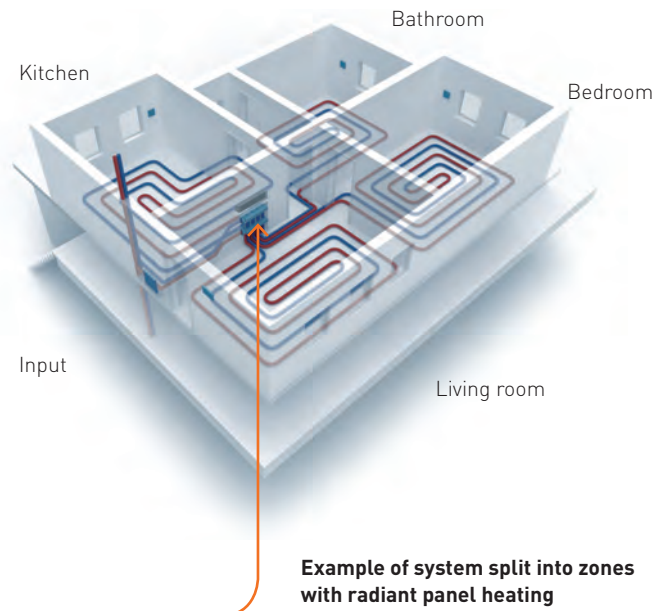
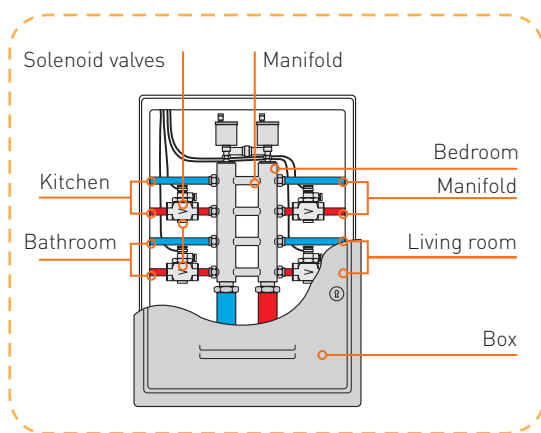

Example of system split into zones with radiant panel heating

TYPES OF MANAGEABLE SOLENOID VALVES

The solenoid valves for the management of the zones must be of three types:

- with ON/OFF contacts



- with open/close contacts



- with open/close contacts 0÷10 Volt

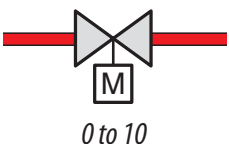

The MyHOME temperature control system can also manage circulation pumps (see figure 4).



WARNING:
proportional mixing valves

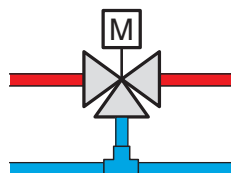

cannot be directly managed by the MyHOME temperature control system. They require an external control unit supplied by the radiant panel system manufacturer.

Temperature control system

TYPES OF SYSTEMS THAT CAN BE MANAGED

a. Radiators

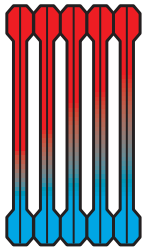

b. Fan-coil

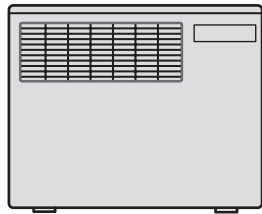

c. Radiant panels

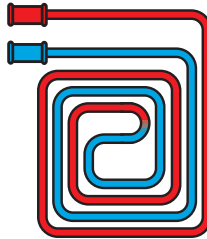

d. Systems:



Heating



Cooling



Both

NOTE:

In central systems with each home fitted with a distribution manifold, it will be possible:

- To install at the manifold input a meter for the measurement of the quantity of heat used;
- To install solenoid valves for managing the different zones of the home.

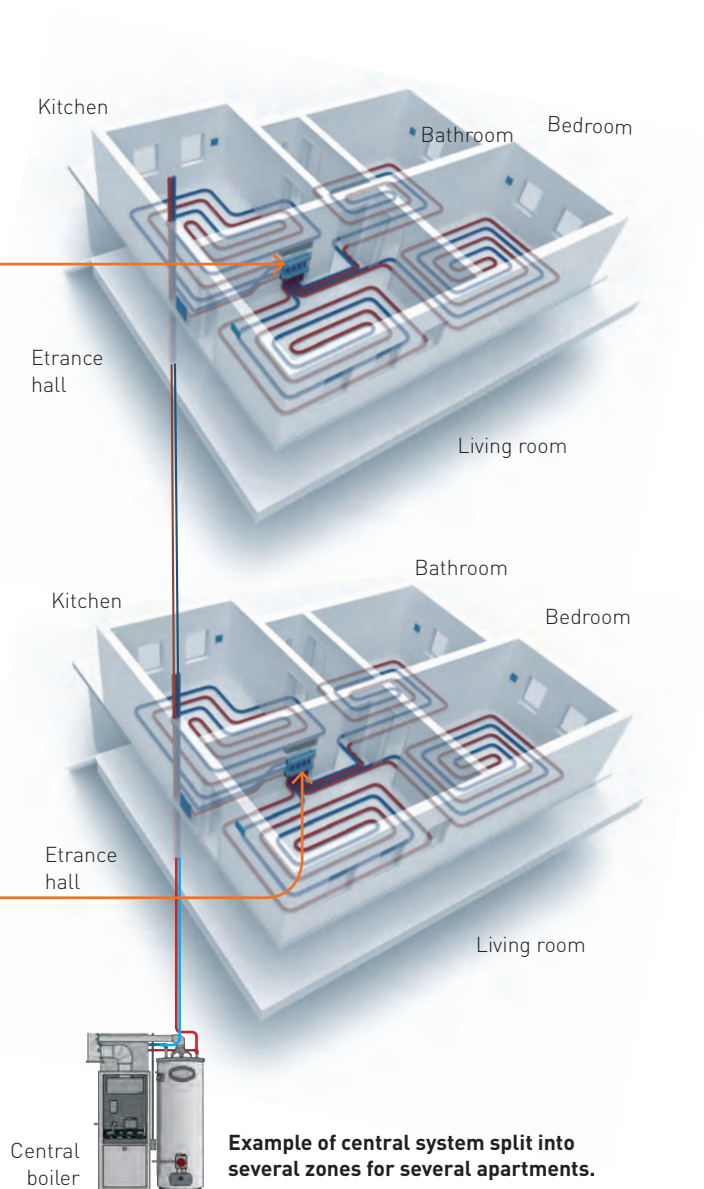
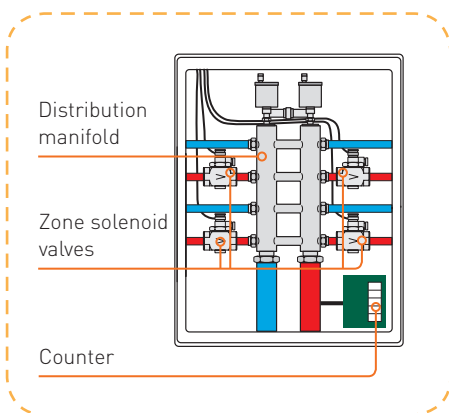

DISPOSITION OF SOLENOID VALVES AND ACTUATORS

The typical setup requires all the solenoid valves to be installed on the manifold, grouped in a box in the boiler room. In this case, it is recommended to group all the actuators in a switchboard and install this near the box itself. In homes with several floors this solution can be replicated for each floor.

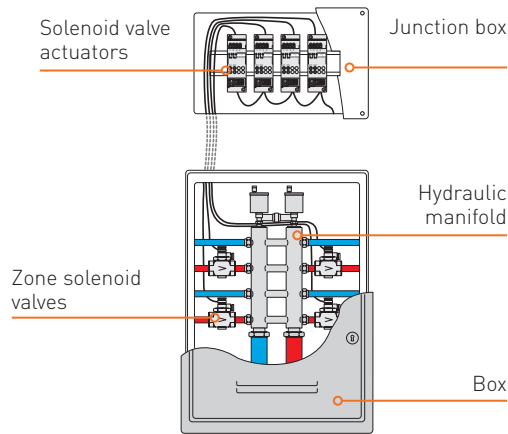

Fan-coil systems

In fan-coil systems the solenoid valve may be installed inside the fan-coil itself. In 2-tube systems there is one single solenoid valve for both the heating and cooling function. In 4-tube systems there are 2 solenoid valves, one for heating and one for cooling.

Installation of the solenoid valve in 2-tube fan-coils

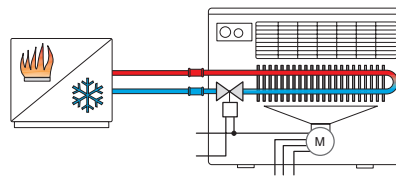

Installation of the solenoid valve in 4-tube fan-coils

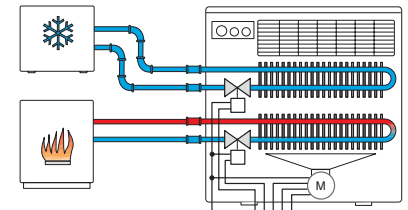

Radiant panel systems

In radiant panel systems, after the pump it will be necessary to install a three-way mixing valve capable of mixing the water so that it does not exceed the maximum set temperature limit. The mixing valve is managed by the control unit supplied by the radiant panel system manufacturer.

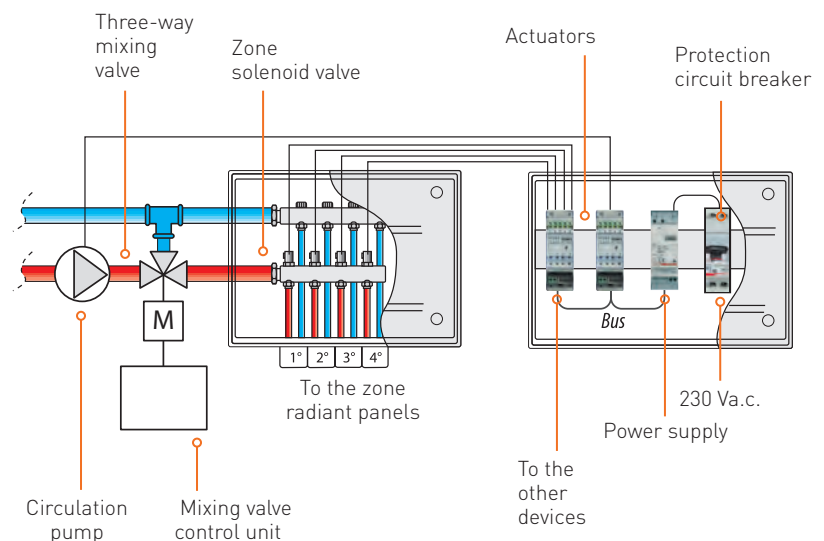

Consumption display and load control system

TYPE OF WIRING

The selection of the way the load is managed (forced reactivation in case of disconnection) and the mode for the display of the energy consumption levels define the characteristics of the electric wiring.

LOAD MANAGEMENT:

- flush mounted actuators combined with power sockets will require distributed BUS wiring, in order to reach the devices in the different device holder boxes.

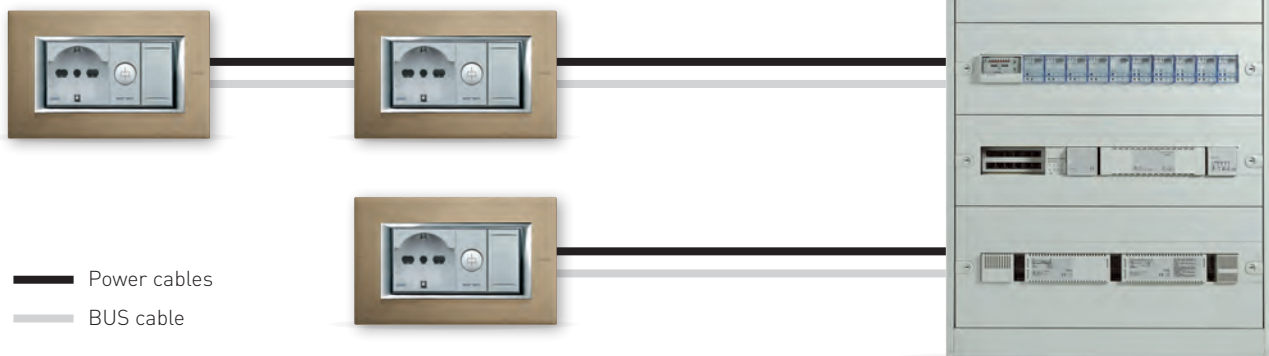

- in case of DIN actuators grouped in the switchboard, allow for the wiring of the BUS where central control and display devices will be installed (load control panel, local display, touch screen, etc.). From each switchboard actuator a dedicated line (phase and neutral conductor) will reach the corresponding controlled load socket.

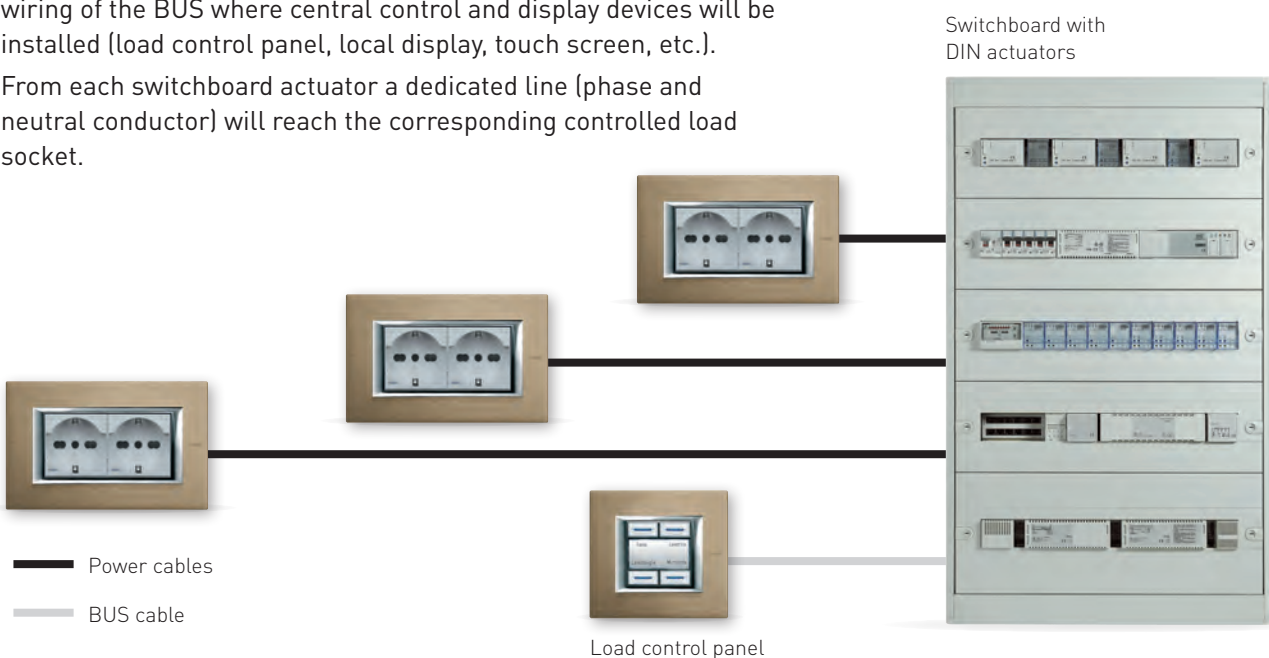

CONSUMED AND PRODUCED ENERGY DISPLAY

Group the DIN module meters in the switchboard. Install energy meters, with their toroids, for each electric line for which the display of consumption is required.

Switchboard

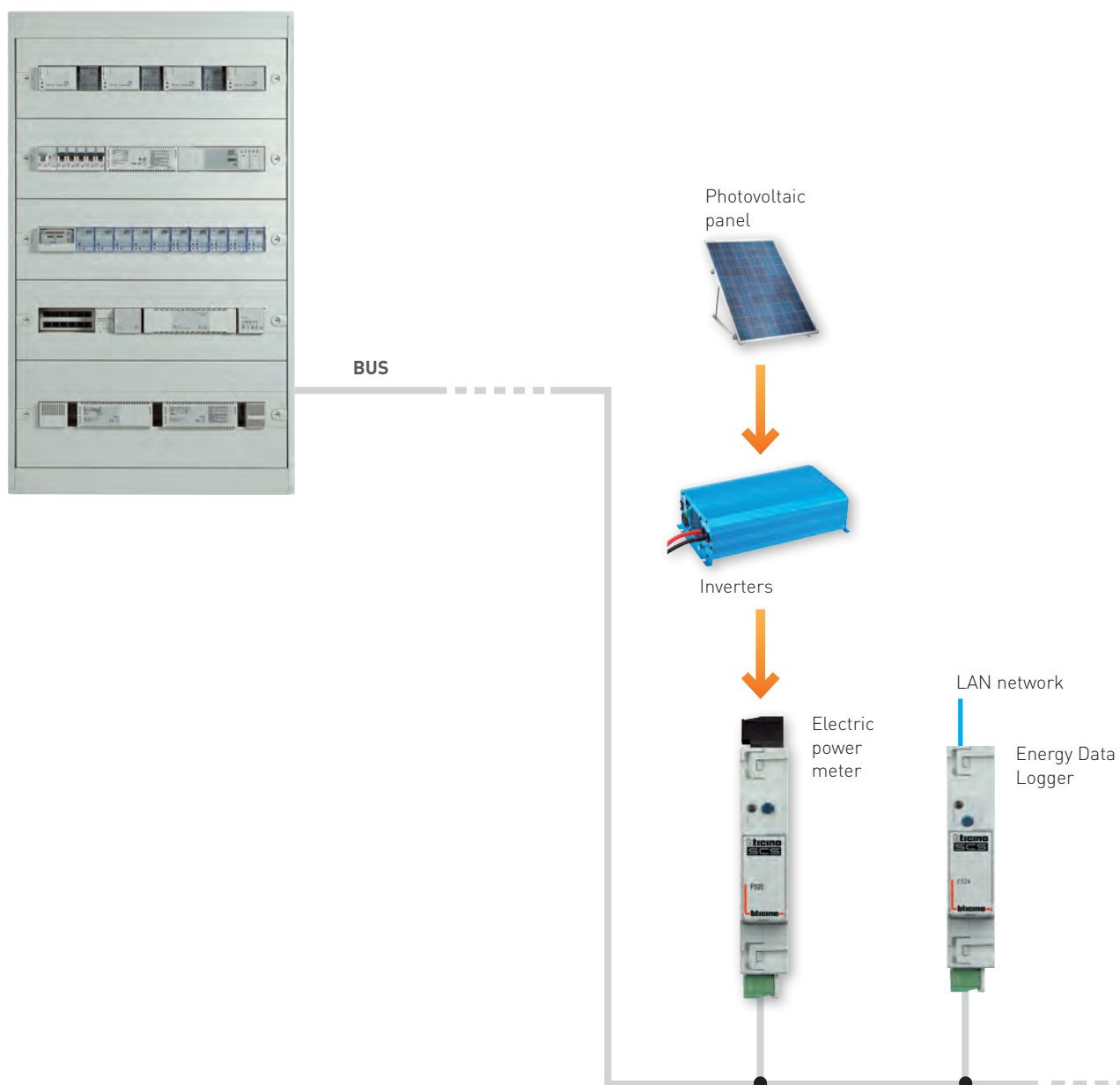

Burglar-alarm system

TYPE OF WIRING

The installation of a burglar-alarm system is completed with 3 different types of wiring.

a) BUS wiring with 4-conductor cable for the parallel connection of the following devices:

- keypad;
- expansion modules;
- telephone communicators;
- sirens.

b) "star" wiring with 4-conductor cable for connection to the control unit of all the sensors (volumetric sensors, magnetic contacts, etc.).

b) Control units with Ethernet port must be connected to the Internet through the home **LAN network** using appropriate wiring.

For further details see the "New Burglar-Alarm System " technical guide.

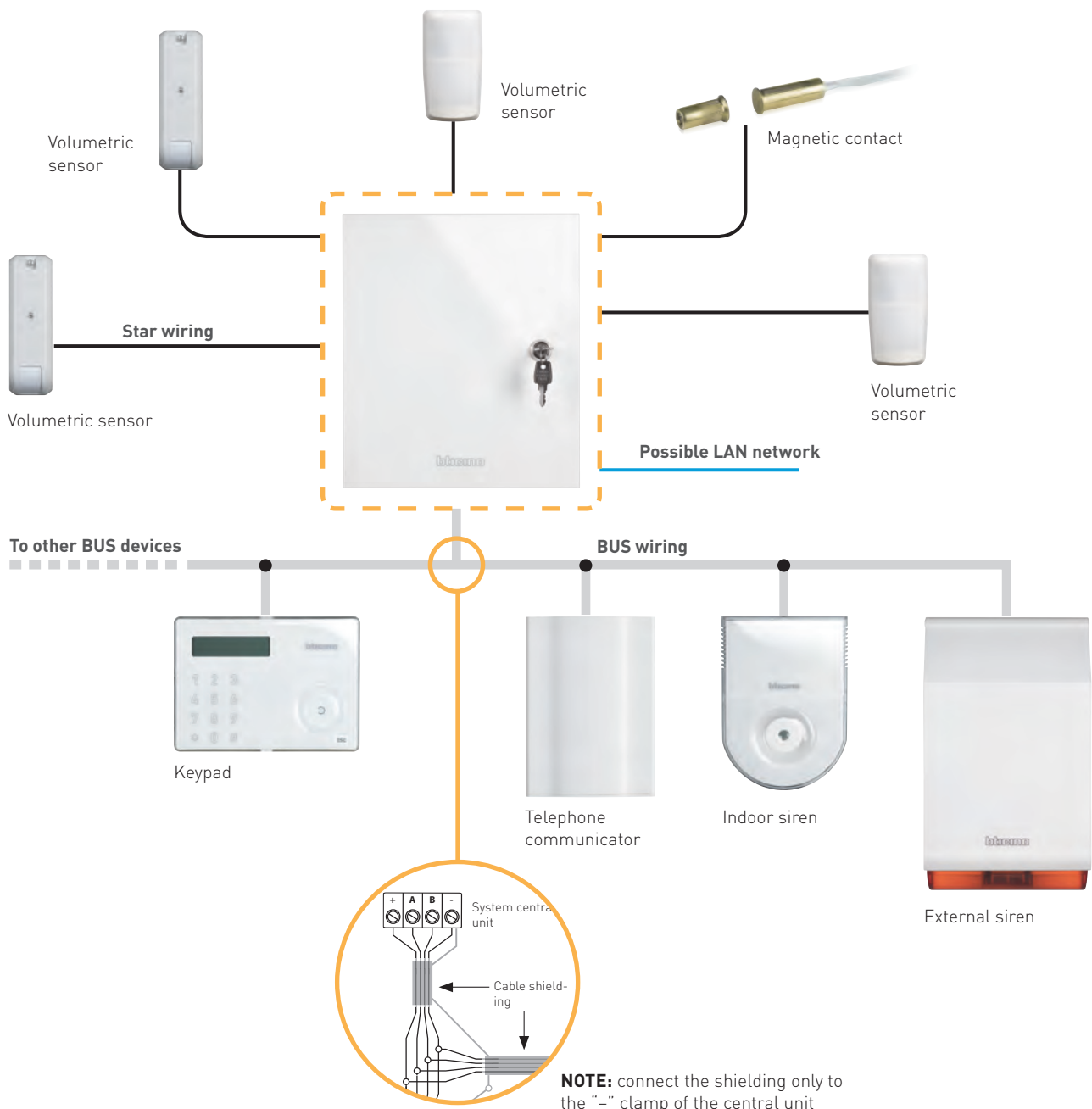

NUVO multiroom audio system

TYPE OF WIRING

IT is possible to create three different types of system:

- **WIRED SOLUTION:** all the players are connected to the LAN network using a network cable belonging to cat. 5E or higher.

The devices can be installed:

- in an appropriate rack;
- in every room (stand-alone installation).

In the first case the wiring of all the speakers is from the rack.

- **WIRELESS SOLUTION:** in this case all the players with their speakers can be distributed freely in the various rooms.

- **MIXED SOLUTION** (wired LAN with radio expansion): if sound systems are to be set up in rooms which do not have wired LAN network a mixed wired-radio system can be created.

For further details see the “NUVO Multi-Room Audio System” technical guide.

When designing the NUVO multi-room audio system, it must be considered that this requires connection to a LAN network with Wi-Fi modem/router, in order to take advantage of shared streaming music services and for any firmware updates for the management of products and Apps.

WIRE SYSTEM WITH RADIO EXPANSION

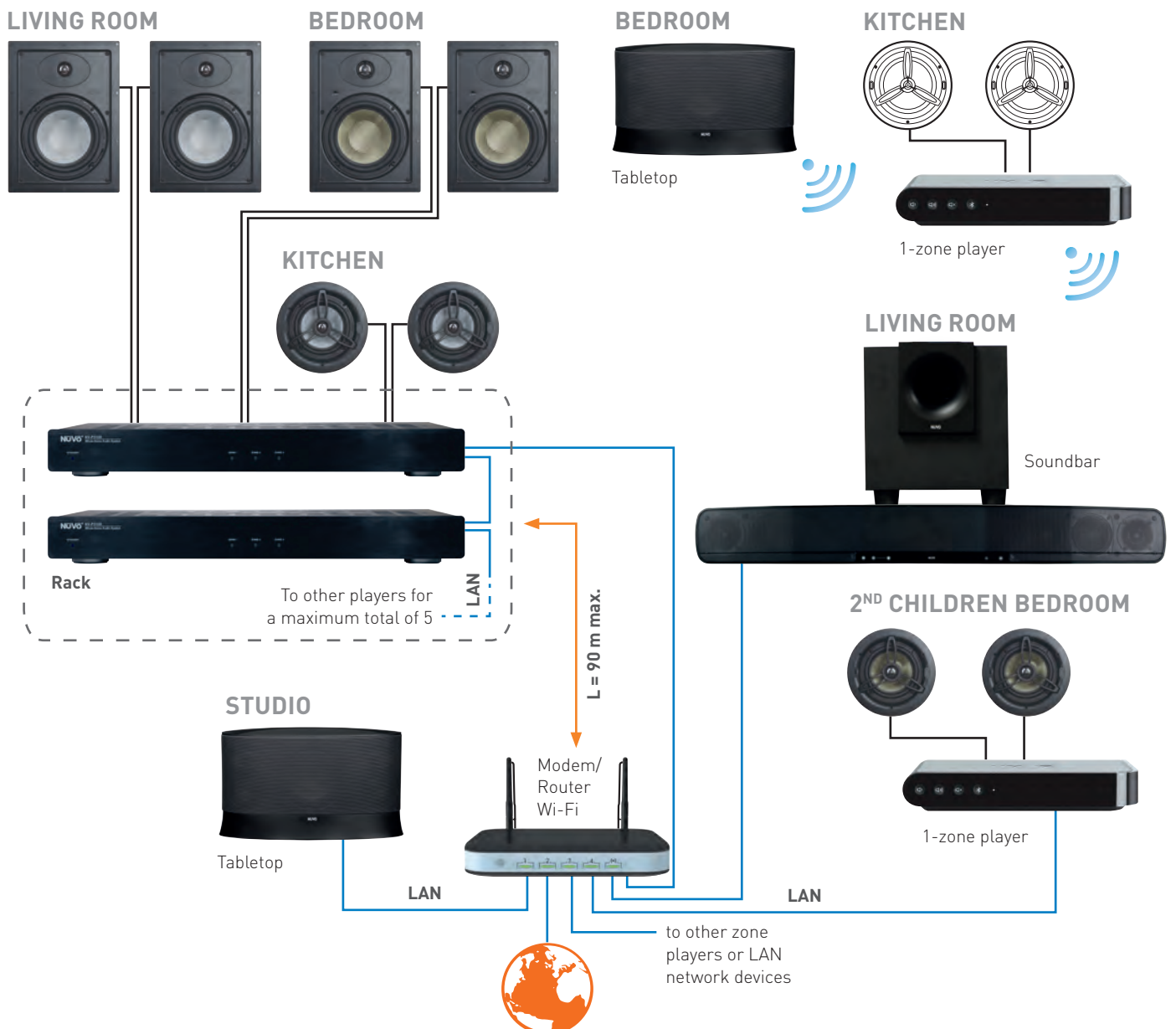

Selection and positioning of the electric panel

The integration of different **MyHOME_Up** systems inside the building brings the need to group in one single central point all the active (power supply units, interfaces, telephone switchboards, etc.) or passive devices that contribute to the control and the management of all functions.

Proceed as follows:

- **For installation in new or existing buildings (restorations), on one or several floors**, for which the creation of a technical room for the electric panel of the home is planned, it will be possible to choose either wall or flush mounted control panels or switchboards of the Multiboard and Idroboard series for the integration of **MyHOME_Up** system.
- **For installation in new single floor buildings and apartments** without any available technical cabinet or room for the Integration of the **MyHOME_Up** system, BTicino makes available **MyHOME FLATWALL**, an innovative solution for the centralised installation of electric and electronic equipment and user interfaces that fully meets the aesthetic requirements of the home.

MyHOME
FLATWALL 240 - 270



MyHOME
FLATWALL 150



Overview of switchboards for surface and flush mounted installation



ELECTRIC PANEL POSITION

The position of the electric panel must be defined based on the type of building. It is recommended to agree with the installer the most appropriate position of the electric panel (if not already decided).

One-floor building

1, 2 or 3 rooms + bathroom and kitchen: install one single electric panel in a central position, for grouping all the DIN devices.

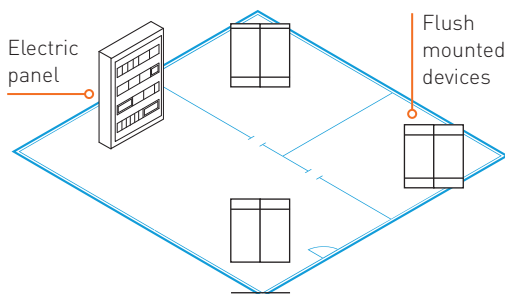

More than 3 rooms and kitchen and bathroom

install one single panel in a central position. DIN devices will partly be centralised in the panel and partly distributed.

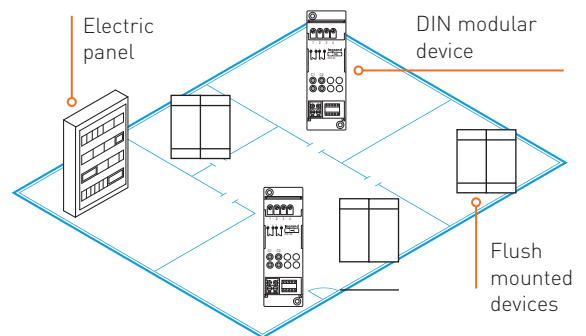

Multi-floor building

Install a main panel in a technical room or under the stairs, and a panel for each floor in a central position. DIN devices will partly be centralised and partly distributed.

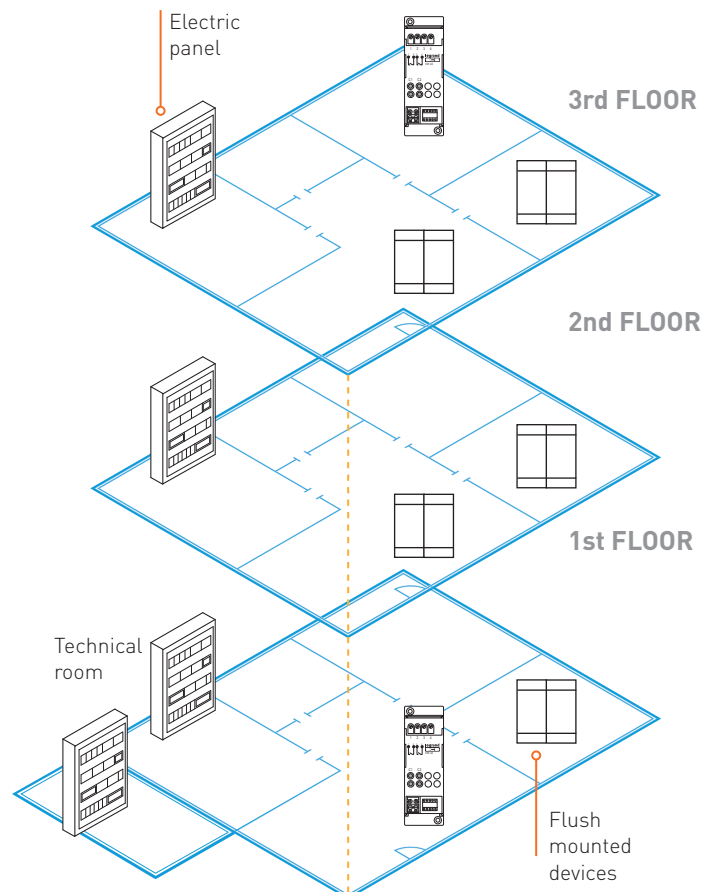

Selection and positioning of the electric panel

MyHOME FLATWALL: AESTHETIC AND FUNCTIONAL VALUE WITH MINIMUM SPACE REQUIREMENTS

MyHome Flatwall features an elegant design and extreme functionality of all its components.

The accessibility to the installed devices depends on the use:

- Some parts are only accessible to the installer, for the maintenance of the installed components;
- Some are also accessible to the end user for interaction with the system.

Thanks to a protrusion from the wall of only 2 cm, finishing panels that can be painted, and the anodised aluminium lateral frame, MyHOME FLATWALL can guarantee maximum integration with its surroundings.

MyHOME FLATWALL 240-270

Available in the switchboard, electric panel and floor riser versions, it allows the management of the distribution of all the electric services in modern homes.

Installation can be made both in masonry walls (load-bearing and partition walls) and in plasterboard walls.

MyHOME
FLATWALL 240 - 270



MyHOME
FLATWALL 150

MyHOME FLATWALL 150

MyHOME FLATWALL 150 is the ideal choice for housing all the necessary devices for a basic home automation system (up to 180 DIN modules) with minimum space requirements. The latest version has aesthetic and functional characteristics in line with those of the well-known Flatwall 240-270. Most of the complements and accessories are compatible with both versions, with the exception of the bottom cable entry points that do not require a tube fastening plate, therefore avoiding to reduce the useful space for the housing of the devices.

Installation possible in both masonry and plasterboard walls.



The Flatwall offer includes a box intended for the installation of multimedia devices (router, modem, etc.) part of the Home network, which is approved by all the main telephone operators.

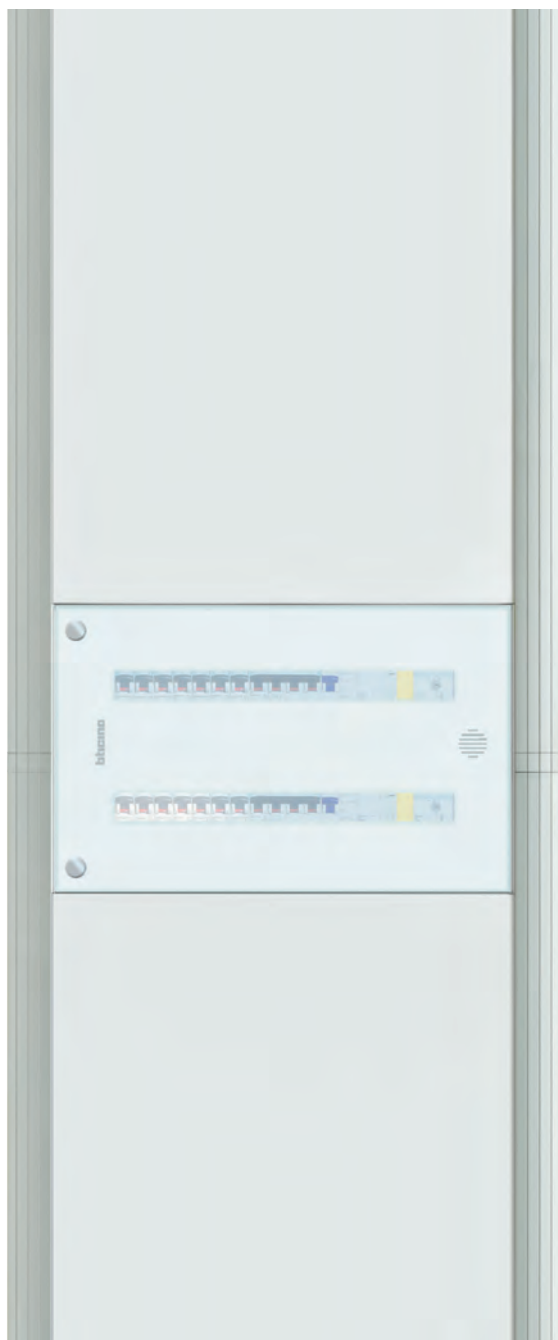

Box intended for the installation of multimedia devices, such as ADSL modems or routers. The installation requires the use of a support for 36 DIN modules (3787).

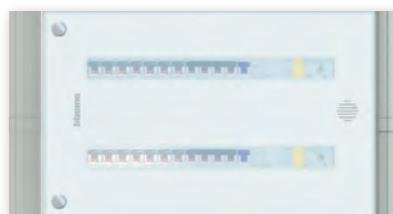

Switchboard for protection and safety devices, accessible to the end user. Available in three versions (glass, metal and plastic), featuring the possibility of reversible installation. The hinged side can in fact be indifferently positioned on the right or the left, so that the door can be opened from the most comfortable and functional side.



Area accessible to the installer with all the power supplies, actuators and other DIN devices (up to 288 modules) for the operation of the MyHOME system. The installation is completed with the white finishing panels.

Selection and positioning of the electric panel

MyHOME FLATWALL: INSTALLATION SOLUTIONS

1 SWITCHBOARD
Configuration for the installation of a 3.5" touch screen, and electric safety earth leakage and thermal magnetic circuit breakers.

2 ELECTRIC PANEL
Configuration for the installation of the DIN power supplies and the actuators of the **MyHOME_Up** system.

EXAMPLE OF FLATWALL H 150 INSTALLATION:
small homes or home automation systems with basic functions.

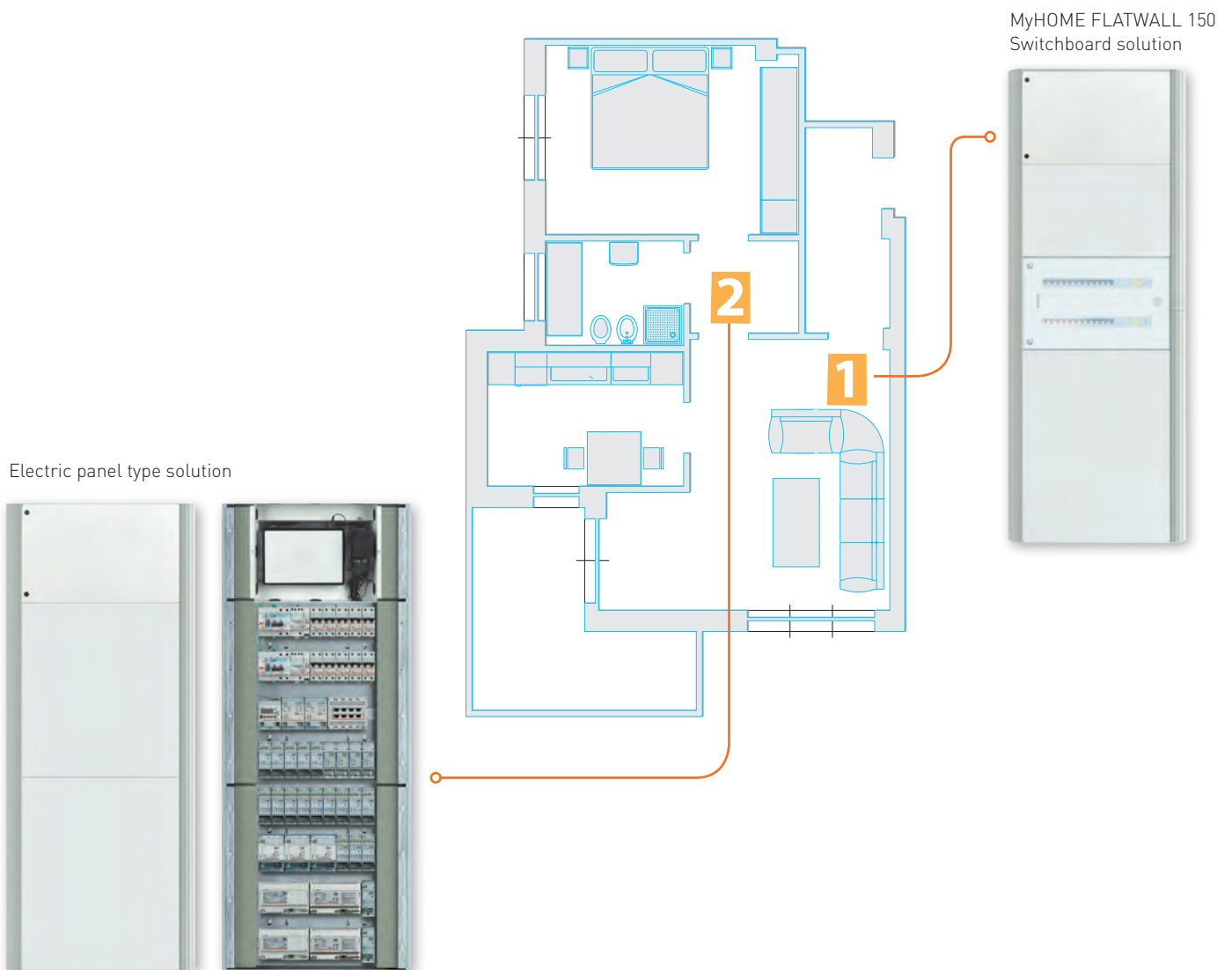

3 FLOOR RISER

Configuration going through the various floors of the building, for wired distribution of common services (only possible with Flatwall 240-270).

All these solutions can be fully integrated with their surroundings thanks to the finishing panels, which are available in white and can be painted using the most common wall paints.

EXAMPLE OF FLATWALL 240 - 270 INSTALLATION

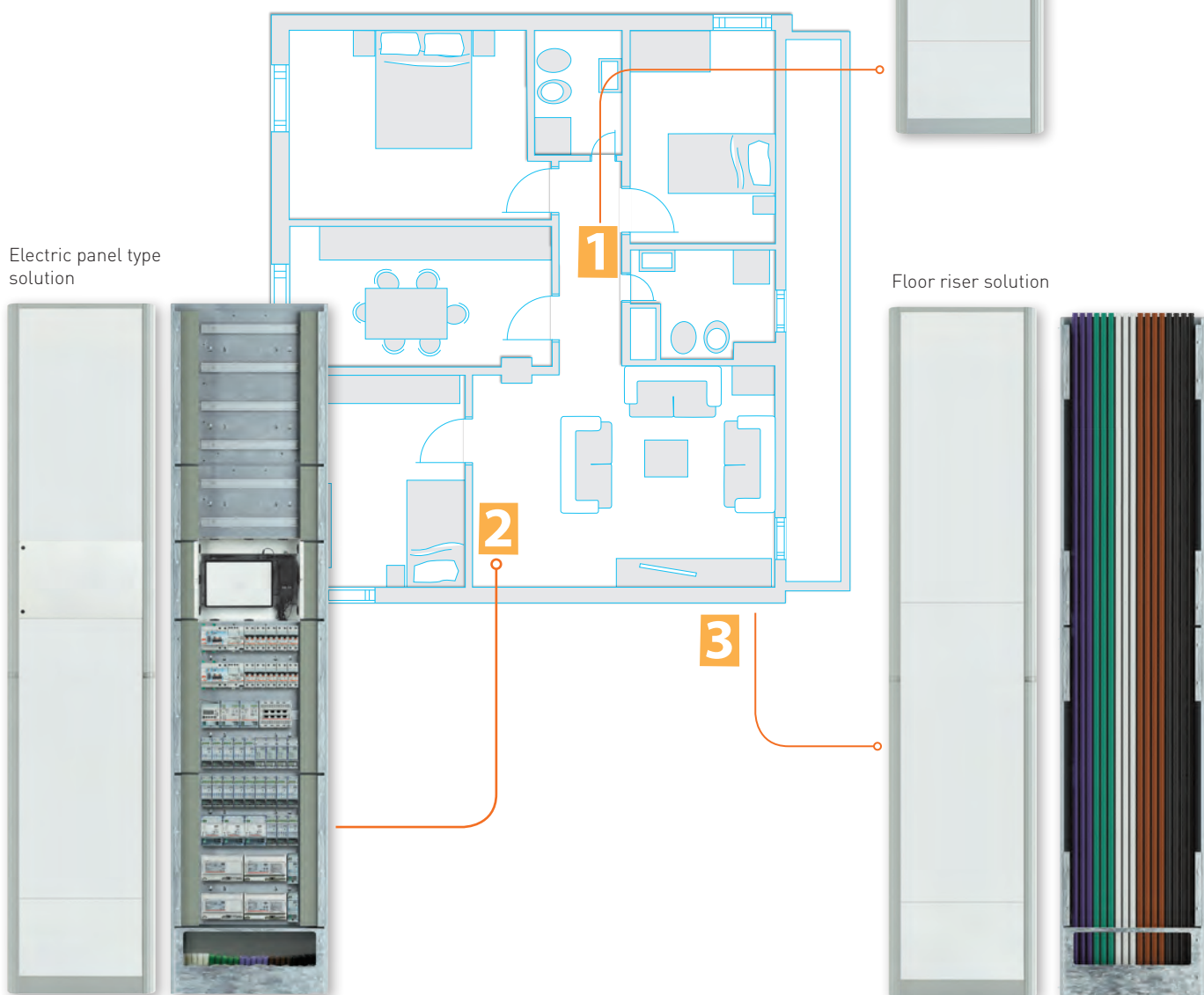

Electric panel type solution

Floor riser solution

Selection and positioning of the electric panel

MyHOME FLATWALL: INSTALLATION

The compact sizes of the flush mounting bases, **only 8.5 cm thick**, make it possible to install MyHOME FLATWALL using the same procedure as for pocket sliding doors.

If installed during the construction of the wall, the metal base also allows construction material savings.

The required device holders can be equipped before being installed, and

then installed on the metal base already in the wall.

To preserve their integrity, the finishing elements can be installed after completing the masonry works.

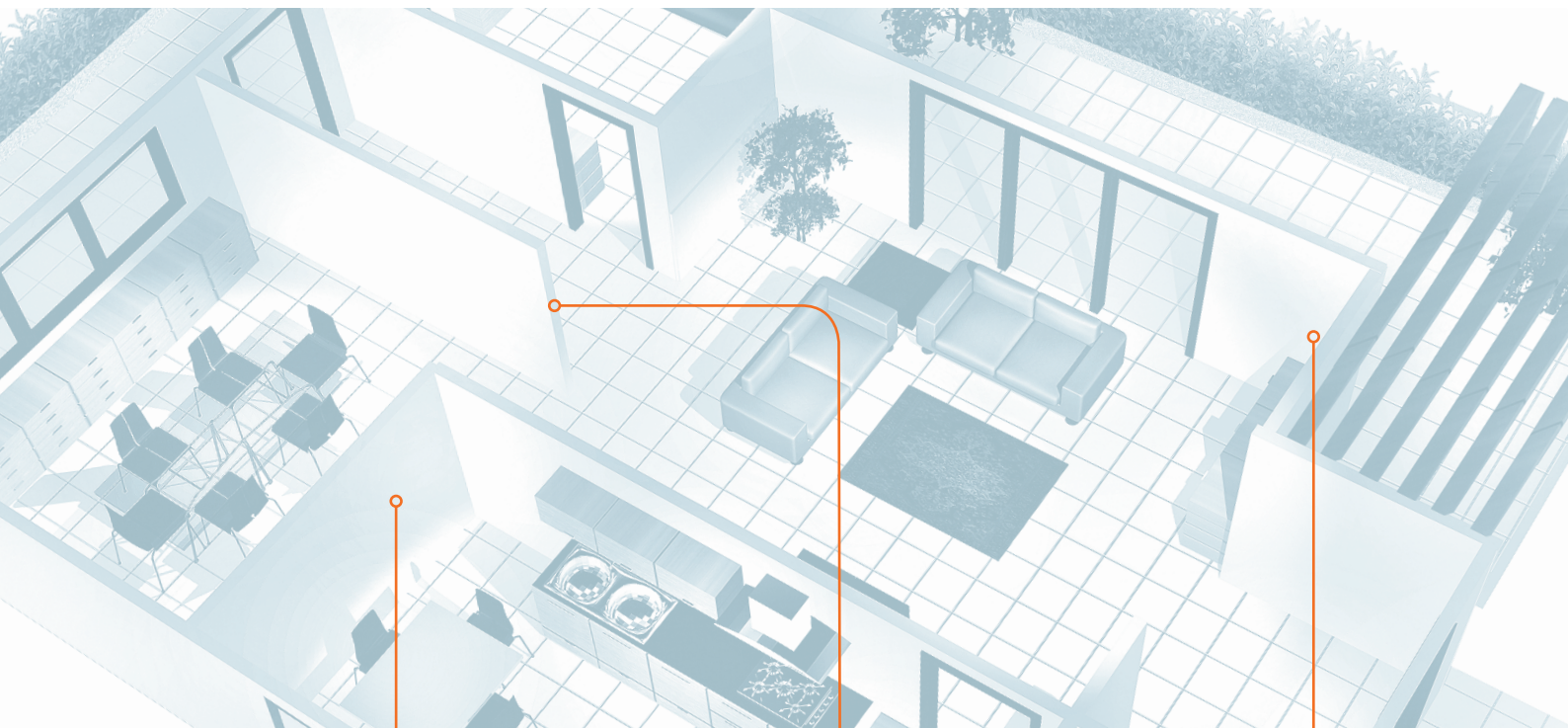

Partition walls

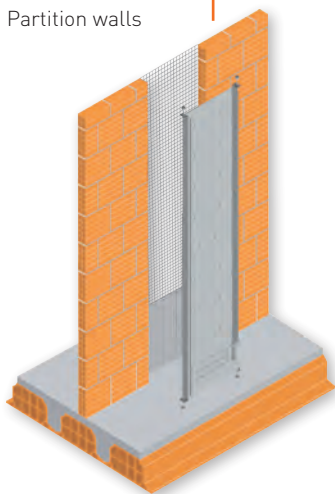

Plasterboard walls

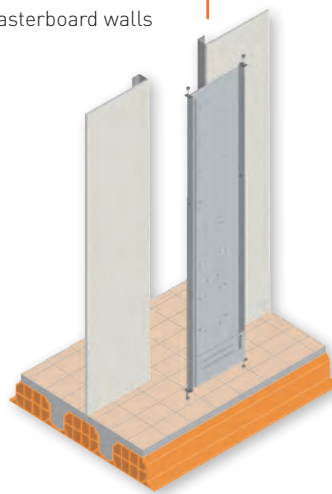

Load-Bearing Walls

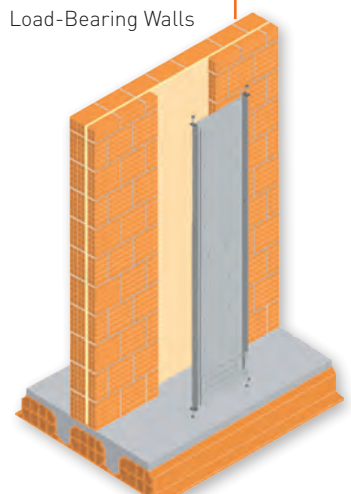

NOTES: for installation in bearing walls, make a 60 cm wide recess from floor to ceiling. For partition or plasterboard walls, leave an opening of approximately 60 cm during the construction of the wall.

Example of typical masonry wall installation.

Area intended for exposed devices that must be accessed for interaction purposes

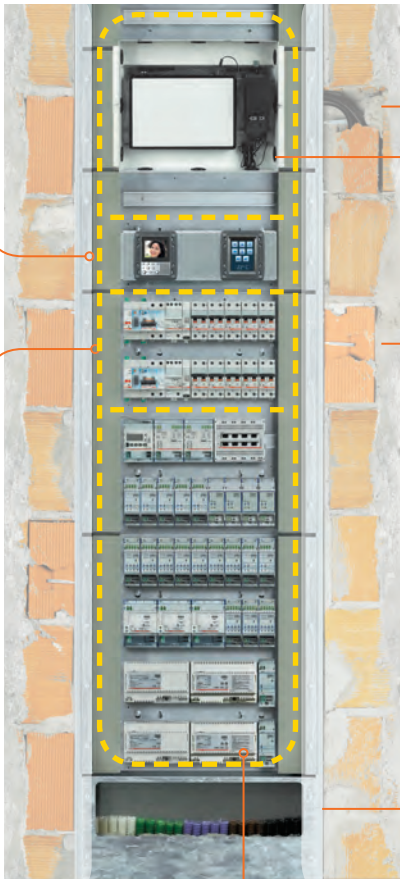

Area intended for protection devices (stop&go, thermal magnetic circuit breakers, etc.)

Area intended for MyHOME devices



Side entry for corrugated pipes.



Box intended for the installation of multimedia devices (router, mode,, etc.). The metal tray, which can only be installed on 36-module device holders, has cut-outs on all the sides for a flexible management of the cable-through areas. 4 rubber cable glands are also supplied as standard, required in order to guarantee the protection of data and power cables. A separate kit with 8 cable glands is also available (3831) in case of installation of multimedia devices requiring a high number of cables. The devices are secured in place using appropriate clips (F496/MF). *



Wall fixing brackets.



Tube fastening plate

In order to facilitate cable entry, MyHOME FLATWALL (240 - 270 H version) has been designed to accept several corrugated tubes, both at the sides, through cut-out holes, and the bottom, where they can be secured in place with a tube fastening plate. This operation is not required for the Flatwall h 150.

* The metal structure of Flatwall limits the Wi-Fi signal. Therefore, during the design it will be necessary to allow for the need for an external aerial.

Positioning of the junction boxes

SELECTION AND INSTALLATION CRITERIA

The position and the quantity of junction boxes must be assessed based on the type of building.

Apartment on 1 floor

- 1, 2 or 3 rooms + bathroom and kitchen: junction boxes are in minimum number and intended for cable joints. All DIN devices are grouped in a central position.
- More than 3 rooms + bathroom and kitchen: junction boxes are also used for housing the DIN devices of the home automation system. DIN devices are partly centralised and partly distributed.

Apartment on several floors

Allow for a junction box underneath each electrical panel, and other junction boxes around the home for housing the DIN devices of the home automation system. DIN devices are partly centralised and partly distributed.

As an alternative, where appropriate install MyHOME FLATWALL in order to group all the DIN devices together in a central position.

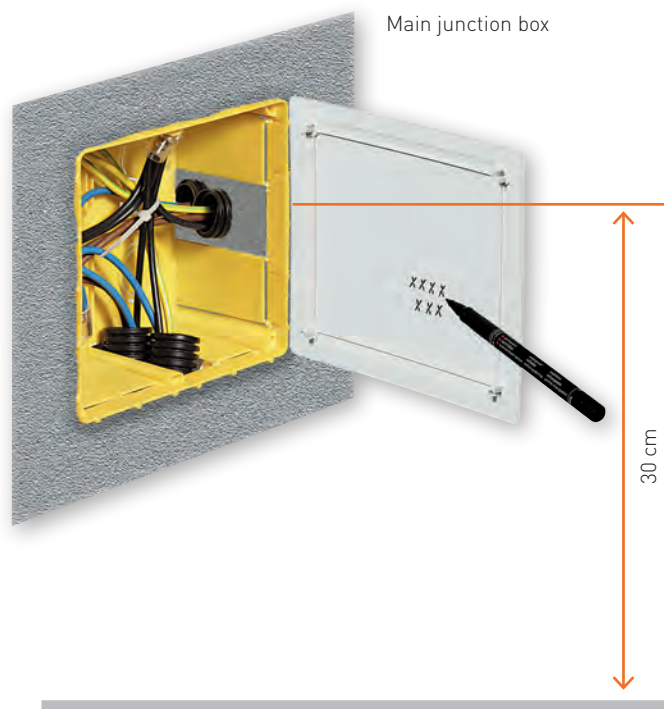

NOTE: For the installation of the boxes refer to the IEC 64-50 standard. The guide recommends a height from the floor exceeding 17.5 cm. We recommend approximately 30 cm.



CONTENTS

MyHOME_Up - Lights and automation

General features 46
Wiring diagrams 64

GENERAL FEATURES

Light and shutter automation system

The system allows to use physical commands, touchscreen devices, smartphones and voice commands to manage the following functions:

LIGHTING

Management of traditional incandescence lamps, and LED, fluorescent and halogen lamps, with ON/OFF and DIMMER mode.

AUTOMATION OF SHUTTERS, CURTAINS AND OTHER DEVICES

Movement of shutters, curtains, doors and other motor-driven devices, with monostable and bistable UP/DOWN (or OPEN/CLOSE) mode and recall of a stored position (Preset function).

LIGHT AND AUTOMATION SCENARIOS

Execution of a range of simultaneous operations called "scenarios". Using a physical device, voice commands, or automatically for calendar-based set events, etc., it is possible to activate at the same time some room lights and the opening of some shutters. If the system is integrated with the NUVO and temperature control systems, background music and desired temperature can also be set.

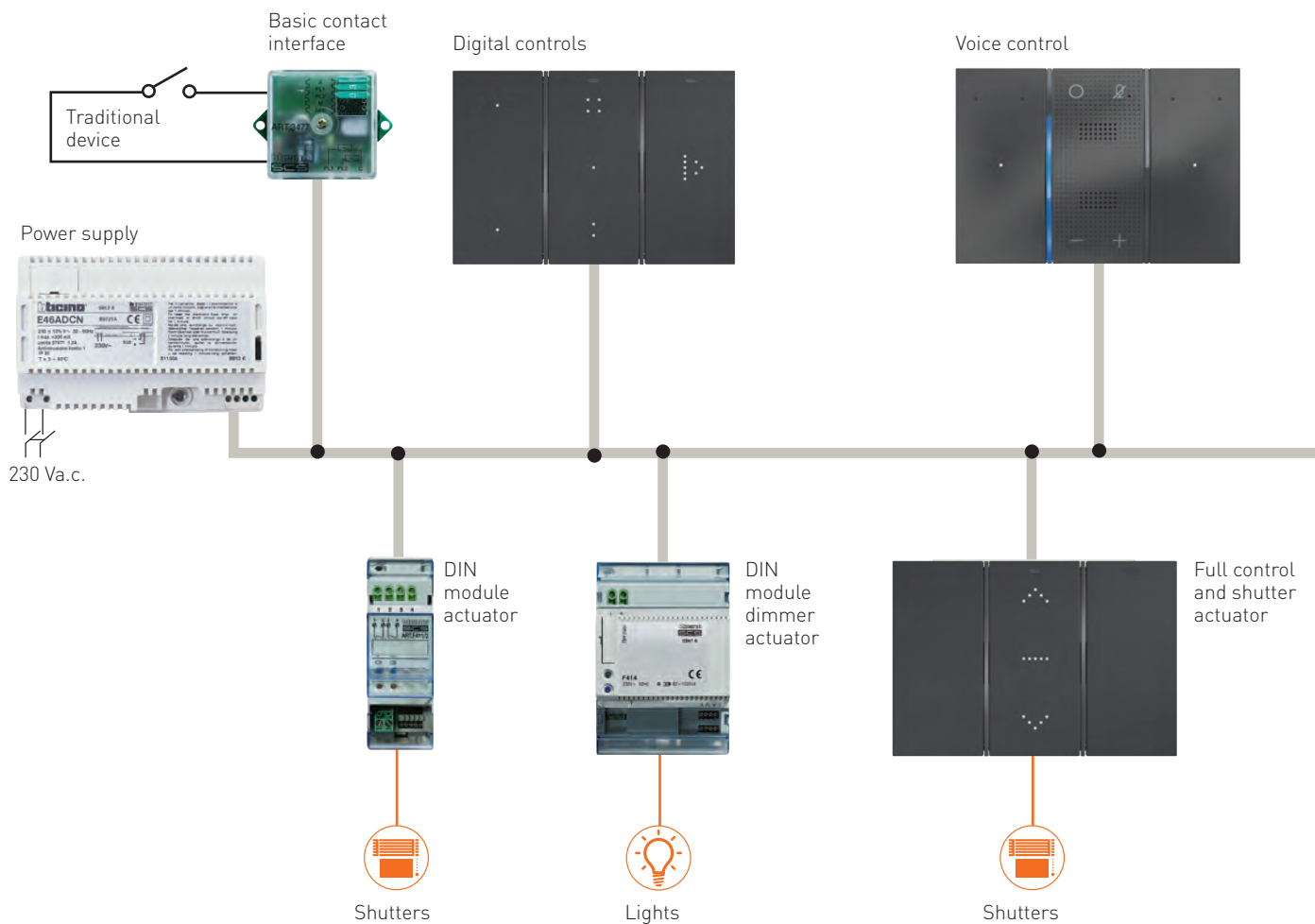

SYSTEM COMPOSITION

In the system there are two types of device:

- Controls, connected only to the BUS wire;
- Actuators, connected to the BUS cable and to the 230 Vac power line to manage the load.

Both devices are available in the advanced digital version, with Living Now finish, or in the version with silk-screen printed key covers, and with Living Now, Axolute, Livinglight and Matix finish.

The range of control devices is completed with other capacitive sensor and IR infrared products.

Digital controls



HOMETOUCH



MyHOME_Up APP

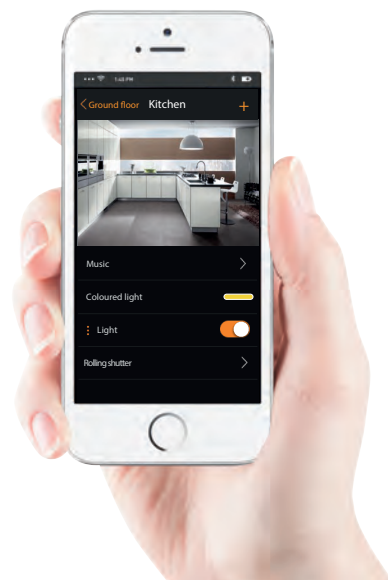

Basic actuator



Lights

Full control and shutter actuator



Shutters

MyHOMEServer1



Light and shutter automation system

LIVING NOW DIGITAL CONTROL DEVICES

These devices are made using construction solutions that simplify assembly and allow the addition or modification of the home automation functions, which can be managed with maximum flexibility. Compared with other civil series controls, the digital control is no longer a 2 module flush mounted element to use with the corresponding key cover, but rather a digital element of reduced size that can be installed without front cover plate.

The function to manage can be recognised thanks to a number of LEDs that make up the function symbol. The installer decides which functions to associate to the commands using the **MyHOME_Up** App. The same App can then be used by the user to customise symbols and functions to personal taste.

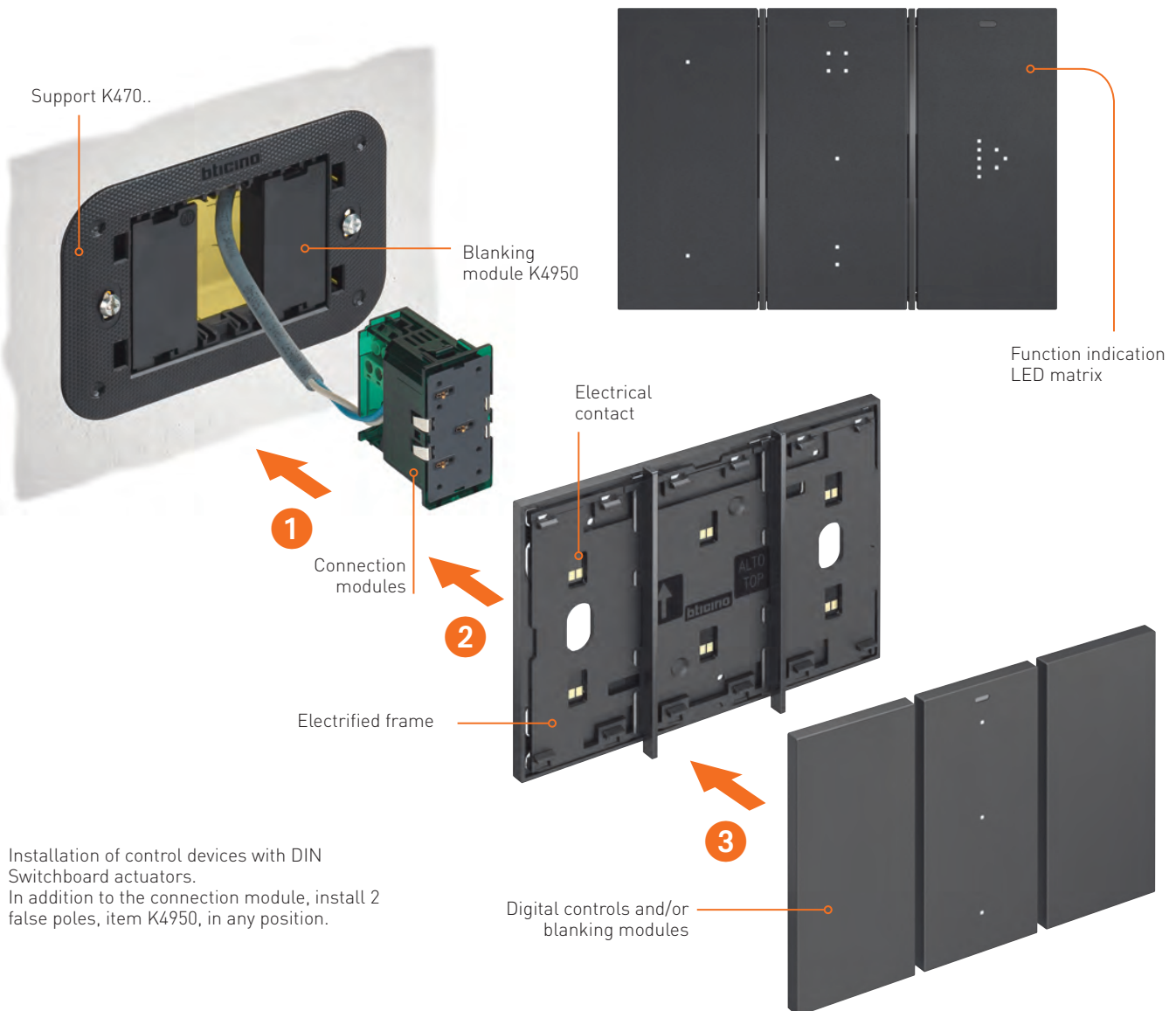

Installation of control devices with DIN Switchboard actuators. In addition to the connection module, install 2 false poles, item K4950, in any position.

They are available in two versions:

- **FULL controls:** advanced devices that can be set using the MyHOME_UP App, with a LED matrix for the definition of a wide range of functions, such as ON/OFF and Dimmer lighting, shutter management, scenarios, NUVO player, coloured light, load management etc. It is possible to simultaneously manage up to 3 different functions.



Shutter UP/DOWN Dimmers Group control Night and day scenario Coloured light

Overview of some icons of the functions managed by the advanced controls.

- **LIGHT controls:** with 3 LED indicators, top, centre and bottom, for the management of 1 or 2 lights. It is possible to also configure controls for the management of 1 or 2 groups of lamps, or for general commands.



Management of one light Management of two lights

With reference to the illustration of the previous page, digital devices are installed in their respective flush mounted box and support, item K470..., using an appropriate "frame" with 27 Vd.c. control device power supply contacts.

The BUS cable is connected to the electrified frame using the connection module, item K8001.

This solutions simplifies wiring of two or more control devices as it is no longer necessary to have a "parallel" connection of the BUS cable. At the same time, it also facilitates the replacement and repositioning of the control device, also by the user, without the need for wiring.

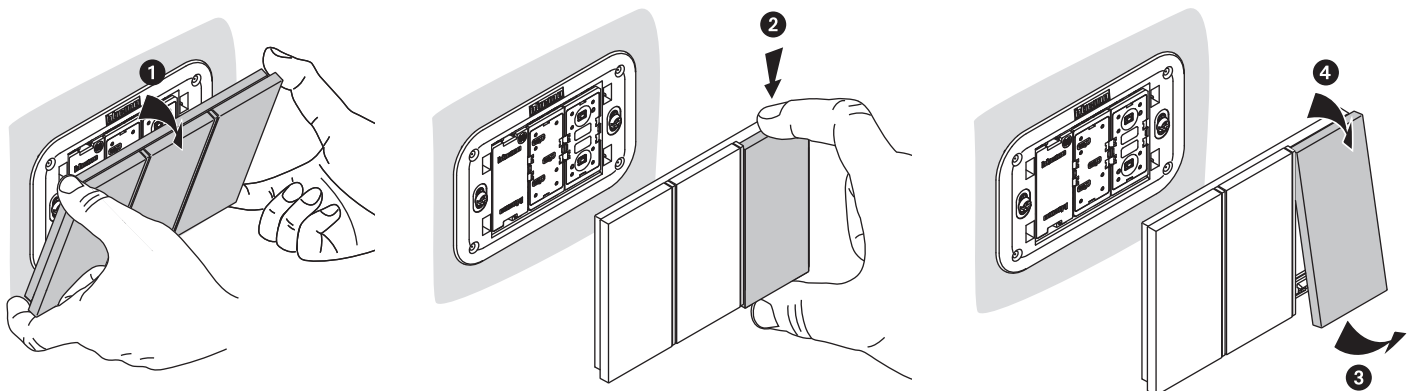











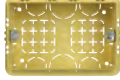









Removal of the control devices from the electrified frame for installation in a different position.

GENERAL FEATURES

Light and shutter automation system

COMPOSITION OF DIGITAL CONTROLS

For each type of box, the electrified frames used and the number of devices and the accessories that can be installed are indicated.

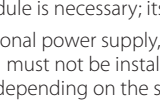
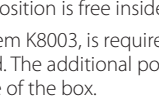
Flush mounted boxes	<p>2 modules</p>  <p>502E (70x70x50 mm)</p>	<p>3 modules</p>  <p>503E (108x74x53.5 mm)</p>	<p>4 modules</p>  <p>504E (133x74x53.5 mm)</p>		
Plasterboard boxes	 <p>PB502N (ø 71x50.5 mm)</p>	 <p>PB503N (110x71x52 mm)</p>	 <p>PB504N (132.5x71x52 mm)</p>		
Supports	 <p>K8102</p>	 <p>K4703 with screws</p>	 <p>K4704 with screws</p>		
Flush mounted devices - connection module K8001; - actuators K8002L and K8002S; - additional power supply K8003 (2 modules).	 <p>3 modules</p>		 <p>4 modules</p>		
Blanking module K4950	 <p>max. 2 blanking modules</p>		 <p>max. 3 blanking modules</p>		
Electrified frame	 <p>3 modules ..8102P1</p>	 <p>3 modules ..8103</p>	 <p>3+1 modules ..8103P1</p>	 <p>4 modules ..8104</p>	 <p>4+1 modules ..8104P1</p>
Voice control item ..8013 (3 modules)					
Digital control Light item ..8010 and Full item ..8011					
Cover for blanking module item 4950					

WARNING FOR THE SELECTION OF THE DEVICES:

- Note (*) The connection module is necessary; its position is free inside the box.
- If the installation of the additional power supply, item K8003, is required for the voice command, item ...8013 (see the MyHOME_Up guide for the details), connection module item K8001 must not be installed. The additional power supply (space required 2 modules) can only be installed in the electrified frame or together with 1 or 2 actuators, depending on the size of the box.

ALLOCATION OF THE FUNCTIONS TO MANAGE AND CONFIGURATION OF ICONS

Like all the **MyHOME_UP** devices, also with digital control devices the definition of the functions to manage and the association with the respective actuator require the MyHome_Up application and the **MyHOMEServer1** web server.

Using the same App, it will be possible to select the symbol of the function managed.

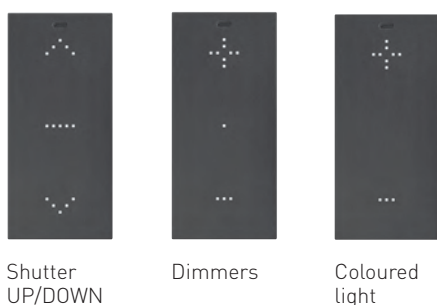

Activation of the MyHOME_Up system - definition of the LIGHT command for the control of two lights.

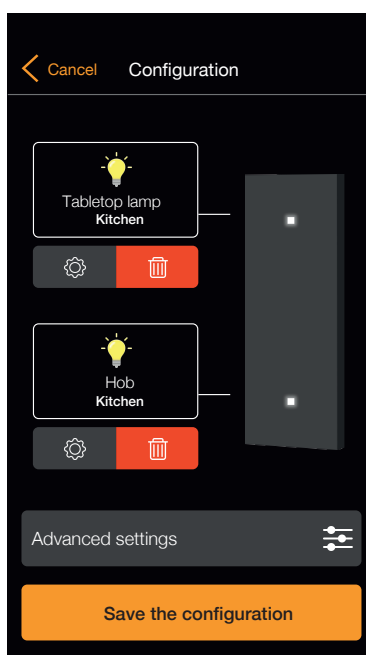

Customisation of the functions by the user - definition of the FULL command for the control of 2 separate light points.

GENERAL FEATURES

Light and shutter automation system

LIVING NOW DIGITAL CONTROL DEVICES WITH AMAZON ALEXA VOICE ASSISTANT

The “Voice command” device, item KG/KS/KM8013, brings together the functions of two digital controls for the management of lights with cyclical ON/OFF mode, with an integrated voice assistant exploiting the Amazon Alexa technology.

The advantage resulting from the use of this device is clear: the installer can offer to their customer an added value service, setting “by default” each room of the home

for “voice” control of the home automation functions of MyHOME, and to request any information, news, weather conditions, timetables, and so on, using the Amazon Alexa platform.

The integration of the voice activated controls with the **MyHOME_Up** system is ensured using the MyHOMEServer1 device.



Voice control power supply

The BUS 27 Vd.c. power supply is supplied to the voice command device by the connection module, item K8001, through the electrified frame, item 8103/P1, or item 8104/P.

In addition to the above module, it is also possible to use the extra flush mounted 2 module power supply, item K8003.

For further details, see the technical sheets of the power supply and voice control.

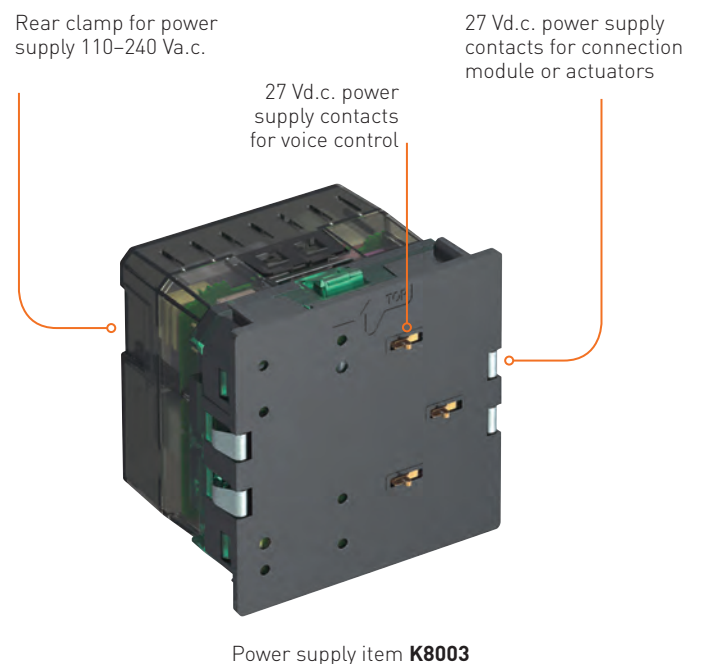

Installation features

The voice command is installed in the respective flush mounted box and support, item K470... using an appropriate "frame" with 27 Vd.c. power supply contacts. Therefore, use connection module item K8001 to connect the BUS cable to the electrified frame.

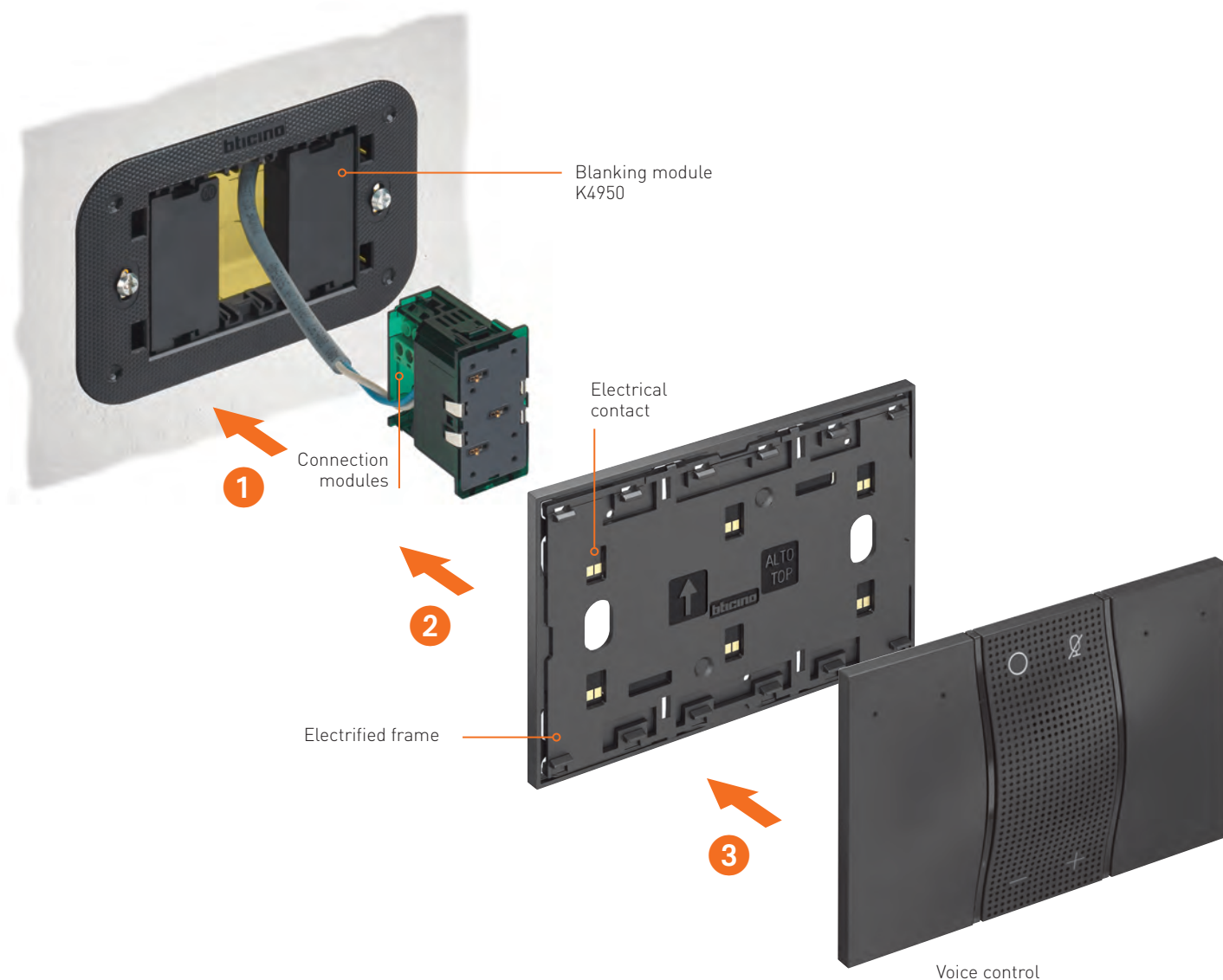

Light and shutter automation system

LIVING NOW 1-MODULE DIGITAL ACTUATORS

These devices can be used with digital controls and are available in two versions:

- for the ON/OFF control of two lamps;
- for the control of a shutter electrical motor.

Both devices are flush mounted using the K470... support and are equipped with side contacts for the 27 Vd.c. electric power supply input directly from the connection module, or through a second actuator.

The association with the corresponding digital control requires the **MyHOME_Up** application.

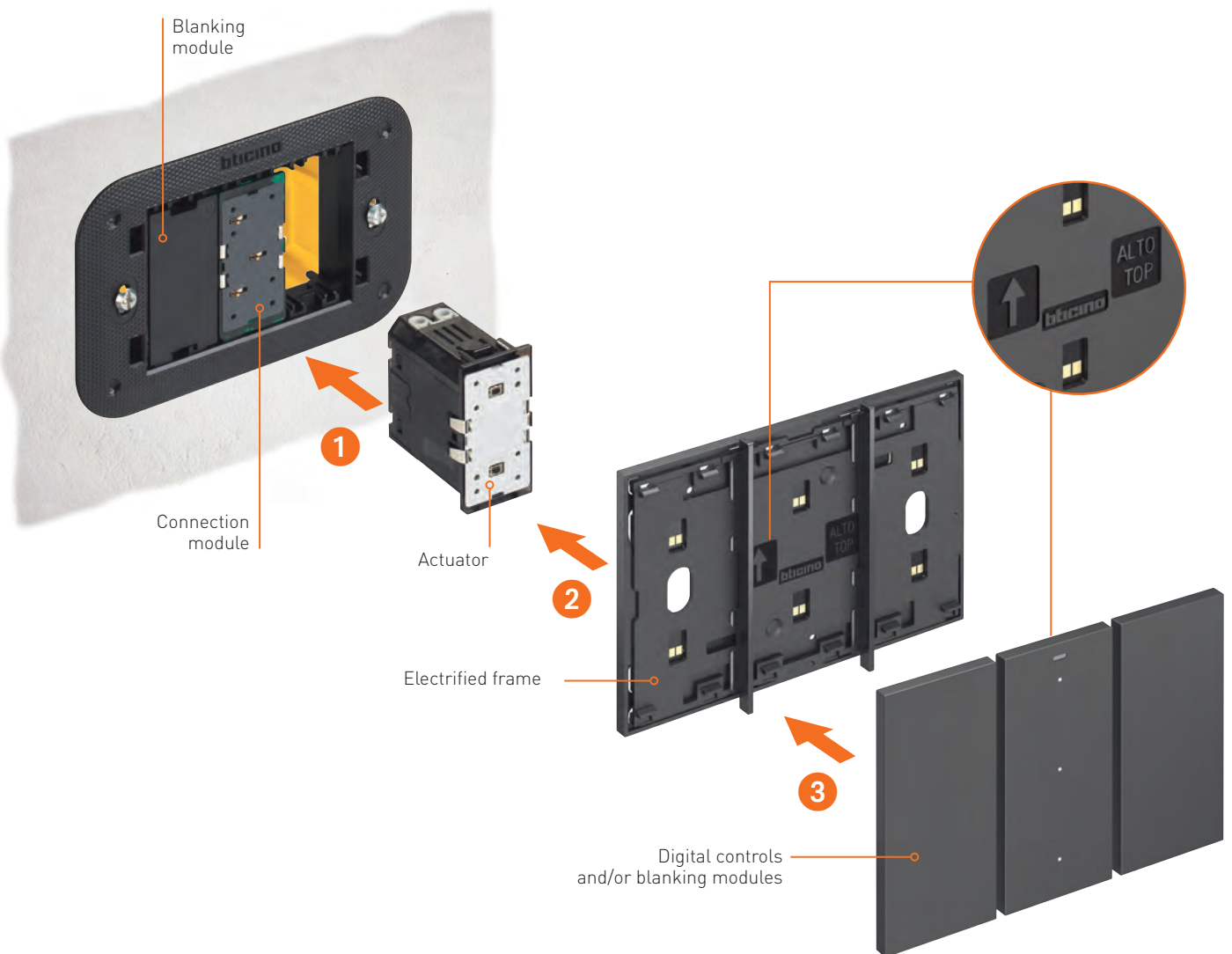
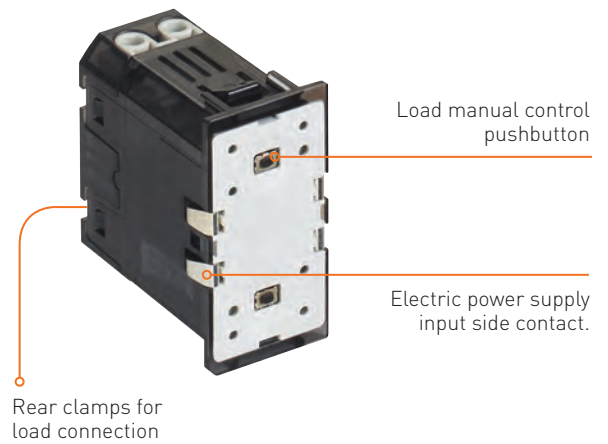

CONTROL DEVICES WITH KEY COVERS

They are completed with two types of keys and key covers:

- With 1 function, one or two modules, to be used with the grey control key;
- With 2 functions, one or two modules, to be used with the black control.

All the devices have luminous indications, which can be adjusted or excluded, for the notification of the status of the load, and so that they can be seen in the dark.

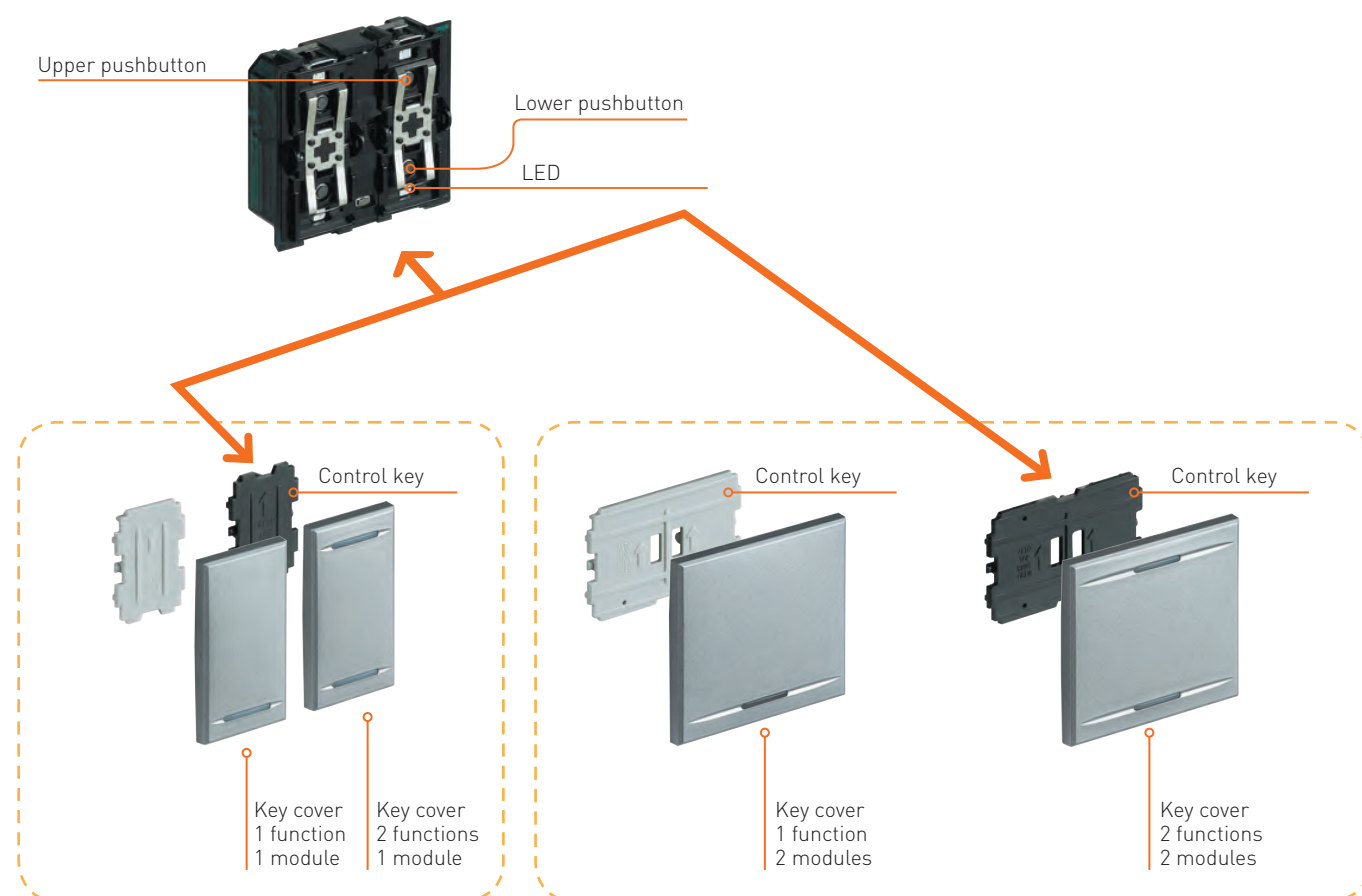

The control with single key cover can be compared with a traditional closing contact (pushbutton or switch).

The control with double key cover (rocker) can, on the other hand, be compared with a traditional exchange contact.

NOTE: the control keys are supplied with the device.

GENERAL FEATURES

Light and shutter automation system

OTHER CONTROL DEVICES

8-key multifunction control item H/LN4652

With 8 backlit keys, this device manages lighting, the automation of shutters and, in integrated systems, also the audio NUVO player system and the scenarios.



Control item **H4652**

Presence and lighting sensors item4658 and item4659

Devices with passive infrared ray presence sensors, ultrasound and light sensors, for the management of lighting based on the presence of people and the amount of natural light, in compliance with the requirements of the highest energy efficiency class for buildings, as contemplated by European Standard EN 15232.



Passive IR movement sensor (PIR) item **AM4659**

Glass controls with capacitive sensors

The mechanical keys are replaced by capacitive sensors which are touch activated. They can be identified by LED with light of adjustable intensity. The functions that can be managed are the same as for the 8-key multifunction control.

Nighter 3-module control item **HS4657M3**

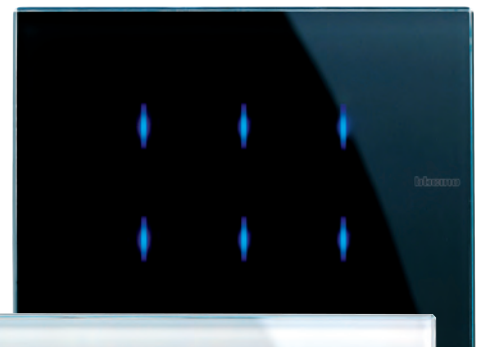

White 4-module control item **HD4657M4**



CONTACT INTERFACES

These devices integrate the traditional control equipment (switch, pushbutton, etc.) in the MyHOME_ Up BUS system and allow their use in rooms where traditional systems are already present or in historic and prestigious rooms whereby the complete or partial remaking of the electric system would entail heavy masonry work.



Contact interface in DIN module item **F428**









Contact interface in basic module item **3477**

GENERAL FEATURES

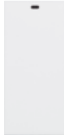
Light and shutter automation system

SELECTION OF THE CONTROL DEVICE BASED ON THE FUNCTION TO MANAGE

		Basic control	Special control	LIGHT digital control	FULL digital control
PERFORMED FUNCTIONS		 H4652/2 L4652/2 AM5832/2 H4652/3 L4652/3 AM5832/3 K4652M2	 H4651M2 L4651M2 AM5831M2	 KW/KG/KM8010	 KW/KG/KM8011
LIGHTING	Cyclical ON/OFF	●	●	●	●
	ON/OFF control with light intensity control	●	●	●	●
	General, room, group controls	●	●	●	●
	Timed controls	●	●		●
AUTOMATION	Normal UP/DOWN and safe UP/DOWN mode shutter control General, room, group controls	●	●		●
SCENARIO MANAGEMENT		●	●		●

8-Key control	Brightness and movement/ presence sensor	Nighter e Whice capacitive control	Contact interface
 <p>H/LN4652</p>	 <p>HC/HD/HS4658 HC/HD/HS4659 L/N/NT4658 L/N/NT4659 BMSE3001 BMSE3003 048834 K4659</p>	 <p>HD4657M3/4 HC4657M3/4 HS4657M3/4</p>	 <p>F428 3477</p>
			●
●	●	●	●
	●		●
			●
			●
●	●	●	●

Light and shutter automation system

FLUSH MOUNTED ACTUATORS

The range of **MyHOME_Up** includes devices for ON/OFF or dimmer control of lighting bodies with powers up to 2300 W, of the type:

- LED;
- fluorescent;
- halogen;
- incandescent;
- supplied with ferromagnetic or electronic transformers;
- ballast 1-10V;
- DALI.

Below are some actuators; for the complete range and the technical features see the "Catalogue" section.

Devices to be finished with key covers - flush mounted installation

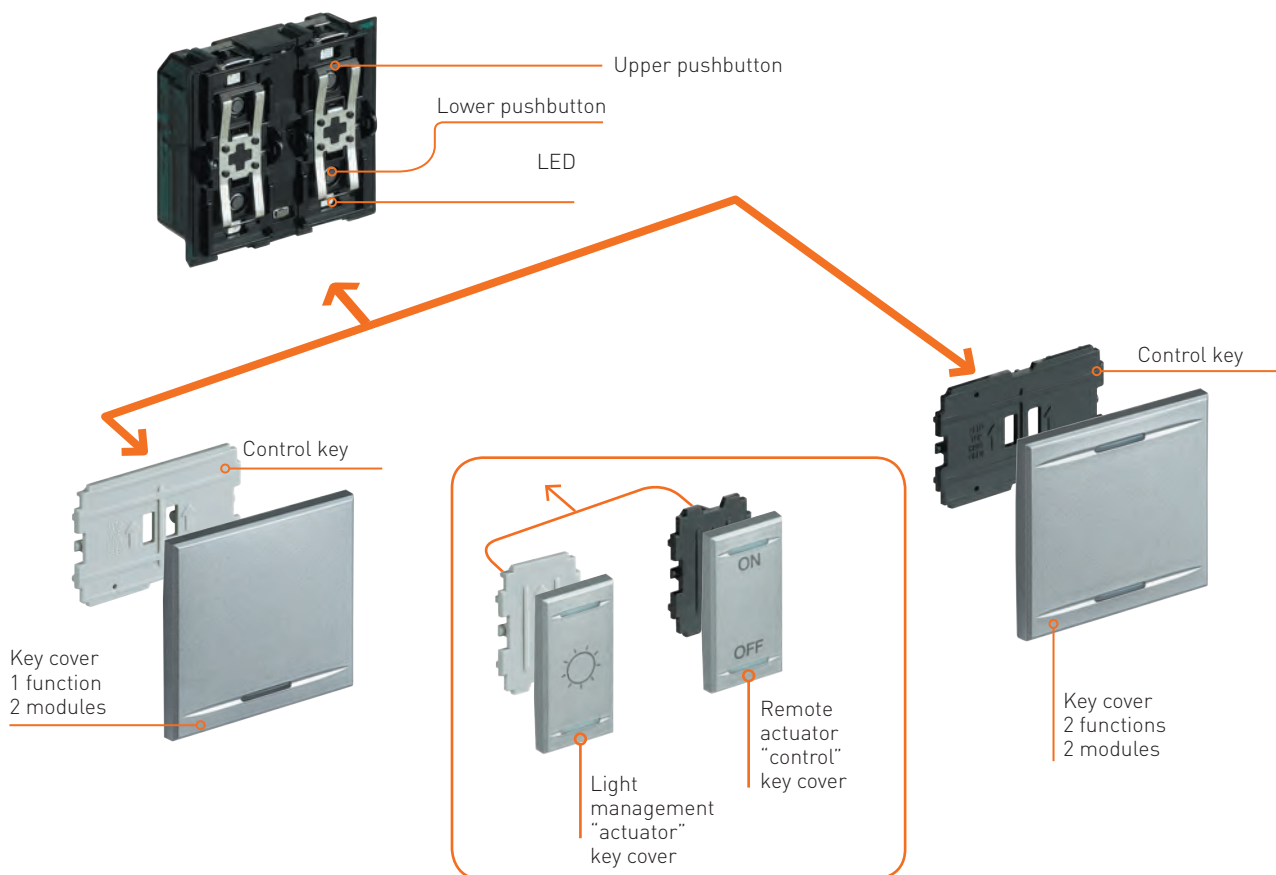

Actuator, item LN4672M2 Livinglight with 1 x 10 A relay for 4 A incandescence lamps, for fluorescent lamps or ferromagnetic transformers, and 500 W for LED and compact fluorescent lamps, for automation and/or load control management functions.

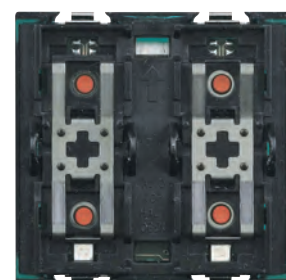

Basic modularity devices - flush mounted installation

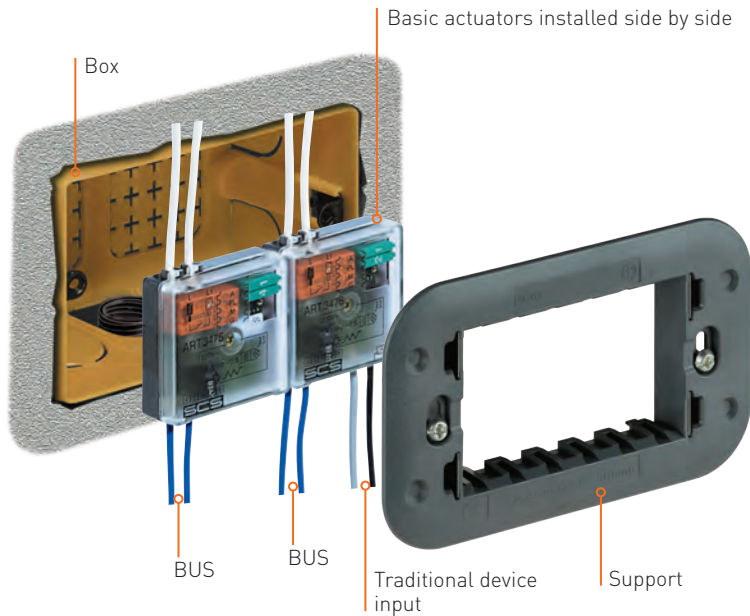

Actuator, item 3476 with 1 relay for single loads: 2 A resistive or incandescence lamps, 2 A inductive for ferromagnetic transformers. Preset for connection with NO type control pushbutton.

DIN modular devices

Dimmer actuator, item F418U2 two-channel dimmer for the management of dimmer LEDs, dimmer compact fluorescent lamps (CFL), energy saving halogen lamps and electronic transformers at 110-230V.

IT is possible to connect two channels with parallel connection, to increase the maximum power that can be managed.



ON/OFF actuator, item BMSW1003 with "Zero Crossing" technology, 4 independent outputs for 16 A maximum loads at 230 V a.c. The device is powered directly from the 100/240 Va.c. mains 50/60 Hz.



GENERAL FEATURES

Light and shutter automation system

ACTUATORS FOR SHUTTERS AND CURTAINS

Different actuators are available for the motor-driven control of shutters and/or curtains with powers up to 460 W:



Actuator, item **LN4672M2** to be completed with key covers, for the control of one shutter or 2 lights.

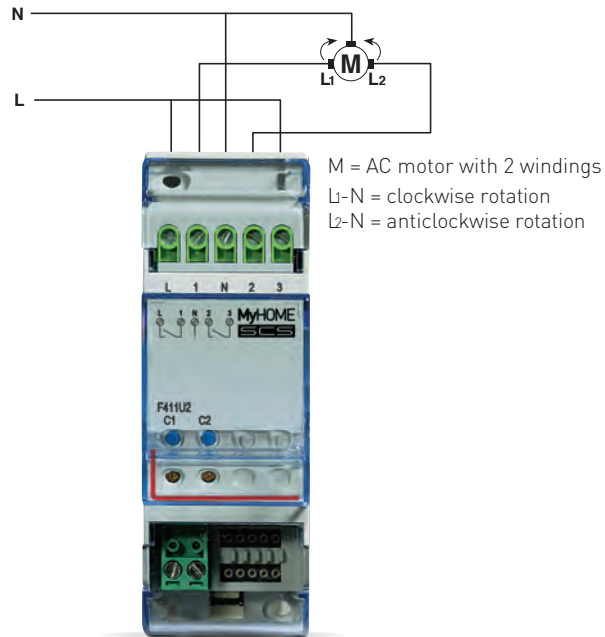

Actuator, item **F411U2** with 2 relays for ON/OFF lighting control. In the diagram, the device is wired for the control of a motor-driven shutter, and must be set in "relay interlock" mode.

Actuators with preset and position calibration function

Devices with 2 interlocked relays for the control of standard motors with automatic calibration, standard with manual calibration, and pulse motors. Available in all the flush mounted civil versions and 2 DIN module versions, to be used with the specific control device.

Preset function:

In addition to the UP/DOWN monostable and bistable functions, these devices allow to move the shutter to a specific position (Preset).

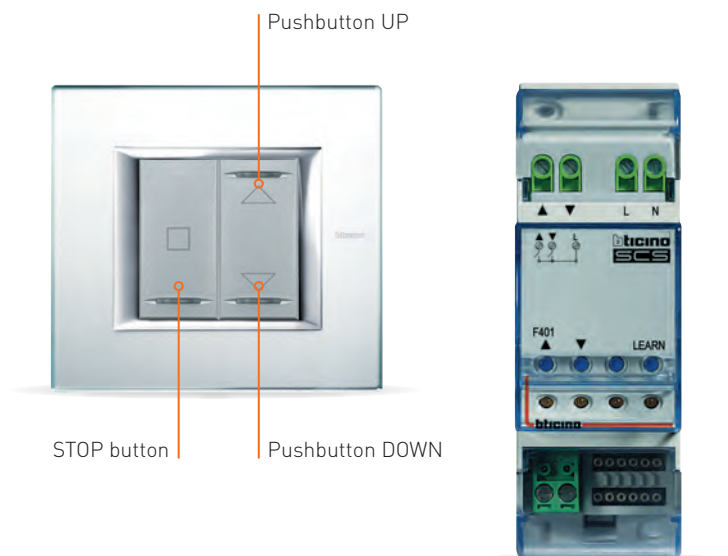

Flush mounted actuator, item **H4661M2** and DIN rail actuator, item **F401**, for shutter control with storage of the desired position.

SIZING OF THE SYSTEM

When sizing the system, check the absorption of the devices to ensure correct system operation. With absorption levels below 600 mA, it will be possible to use compact power supply E49. With absorption levels between 600 and 1200 mA, power supply E46ADCN must be used.

For the current absorption of the device see its technical data sheet.

The length of the cable must also be considered, complying with the following rules:

- The length of the connection between the power supply and the furthest device must not exceed 250 m.
- The total length of the connections must not exceed 500 m (laid out cable).

- For optimum division of the currents on the bus line, it is recommended that the power supply is installed in an intermediate position.

With power supply E46ADCN:

A = 250 m max

B = 250 m max

A + B = 500 m

NOTE: If a UTP5 cable is used in alternative to the L4669 BUS cable, distances are halved.

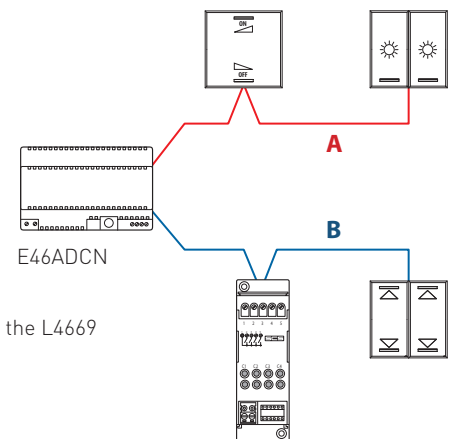

NOTE: For the sizing of the lighting system with light and movement/presence sensors, refer to the technical data sheets of the products available at the bticino.com website and the homesystems-legrandgroup.com website.

Light and shutter automation system

DIAGRAM 1

SWITCHING ON AND OFF OF 2 LAMPS WITH 4 LIGHT POINTS WITH GENERAL ON/OFF CONTROL

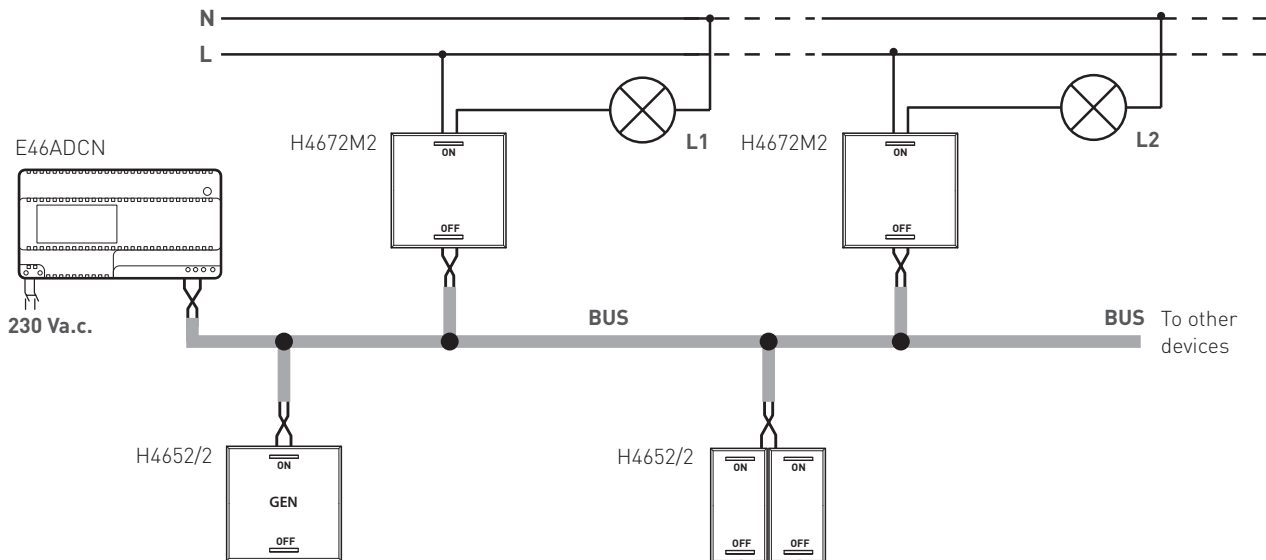
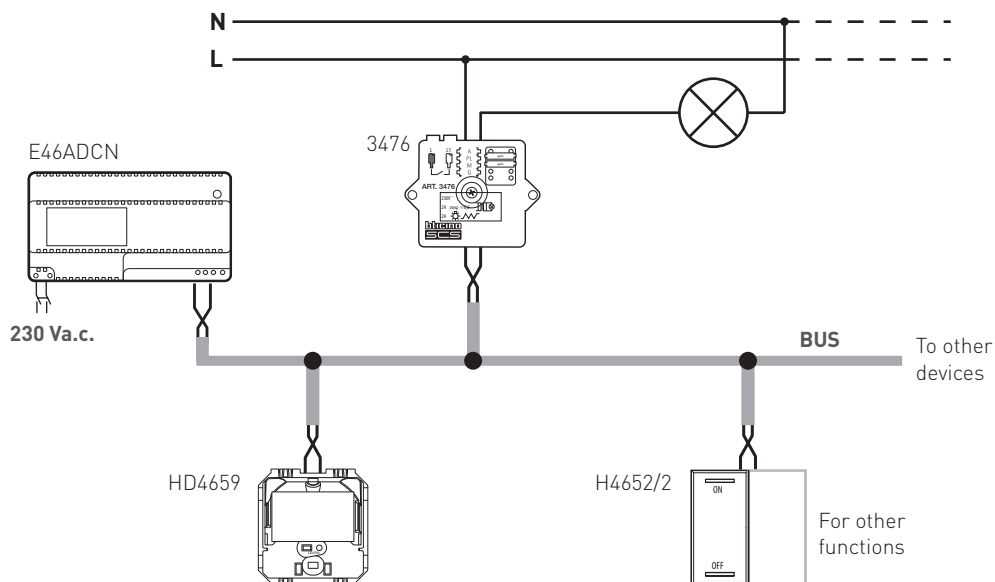

DIAGRAM 2

AUTOMATIC SWITCHING ON OF THE LIGHT WITH PASSIVE INFRARED CEILING SENSOR



The device controls the load with the address indicated in A and PL. When a presence is detected, if the light level is below the set level the device switches on the assigned load and keeps it on for a period of time set using the configurator in T. The sensitivity of the PIR movement sensor is set using the configurator in S. For correct operation, it will be necessary to set the sensor lighting setpoint (see procedure).

DIAGRAM 3

ALTERNATE CURRENT MOTOR CONTROL FOR SHUTTERS, CURTAINS, OR MOTORISED SHUTTERS

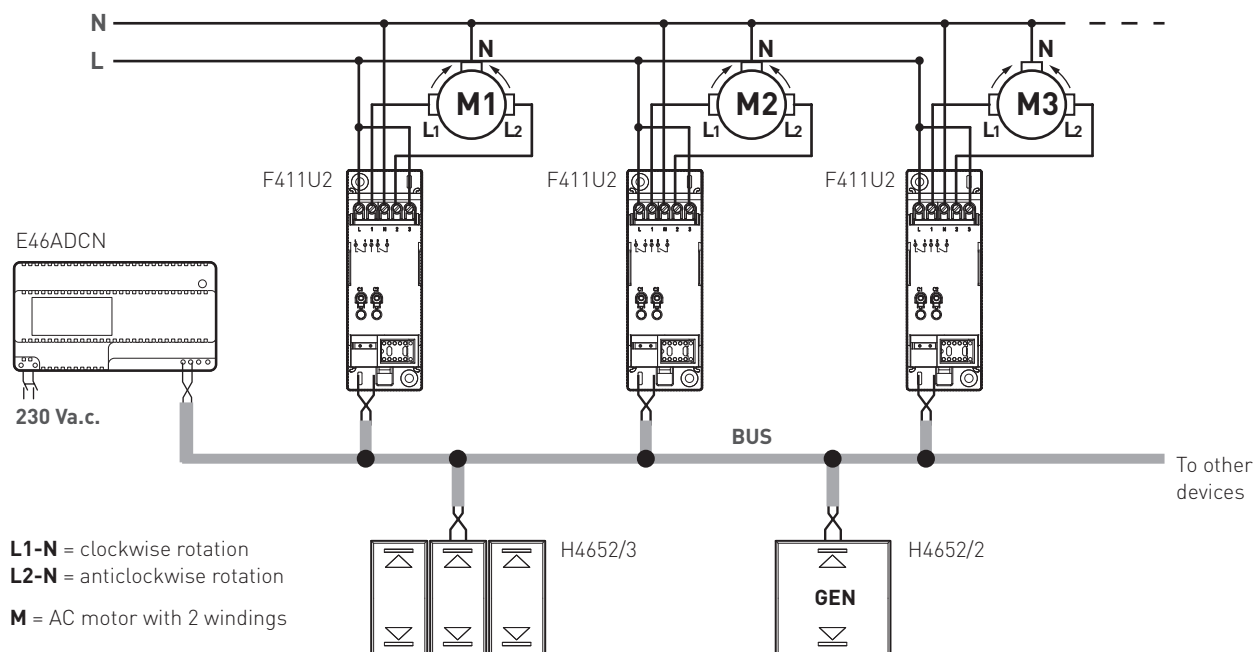
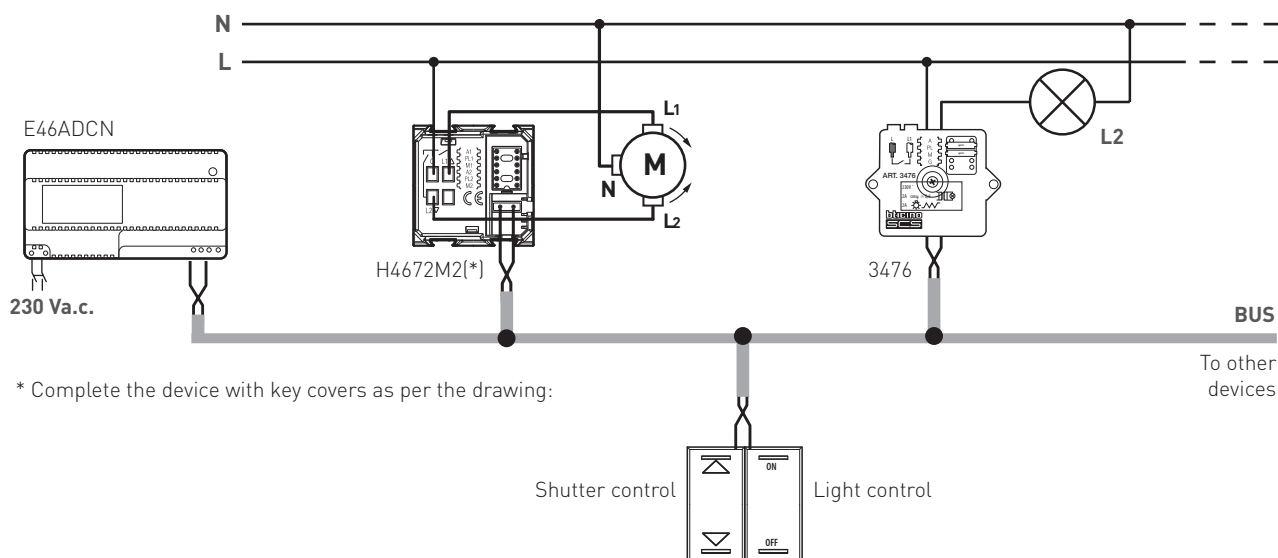

DIAGRAM 4

SWITCHING ON AND OFF OF ONE LAMP AND SHUTTER CONTROL USING AN ACTUATOR CONTROL



* Complete the device with key covers as per the drawing:

Light and shutter automation system

DIAGRAM 5

SWITCHING ON, OFF AND ADJUSTMENT OF THE LIGHT LEVEL OF FLUORESCENT LAMPS THROUGH "BALLAST"

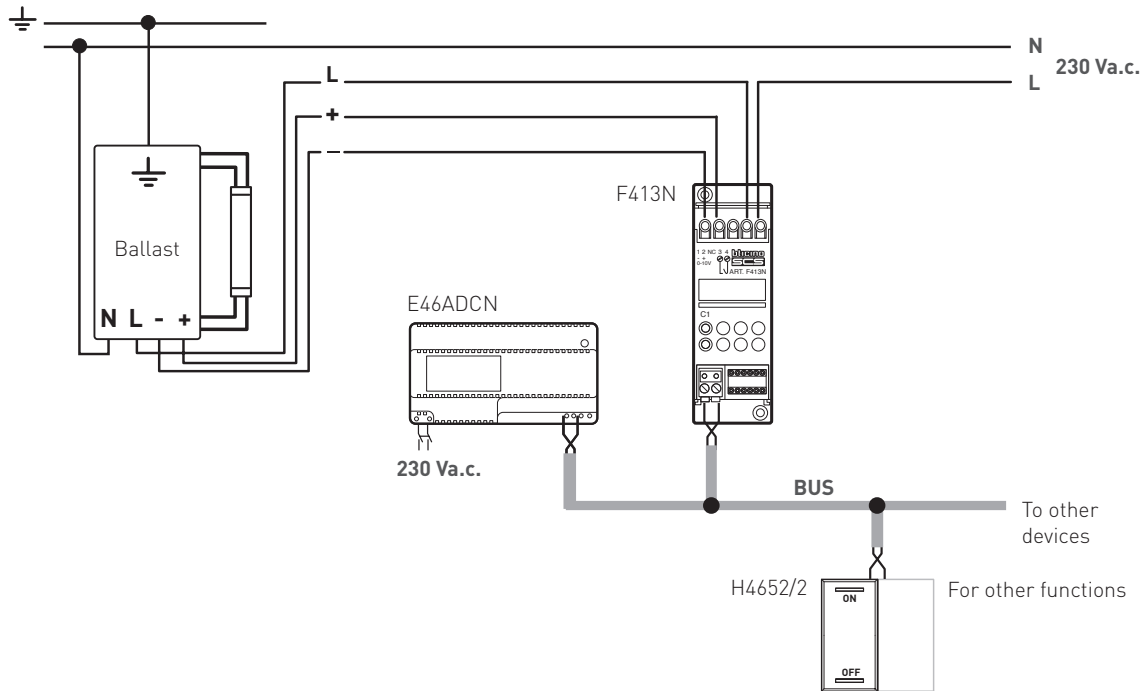

DIAGRAM 6

SWITCHING ON, OFF AND ADJUSTMENT OF THE LIGHT LEVEL OF LED LAMPS

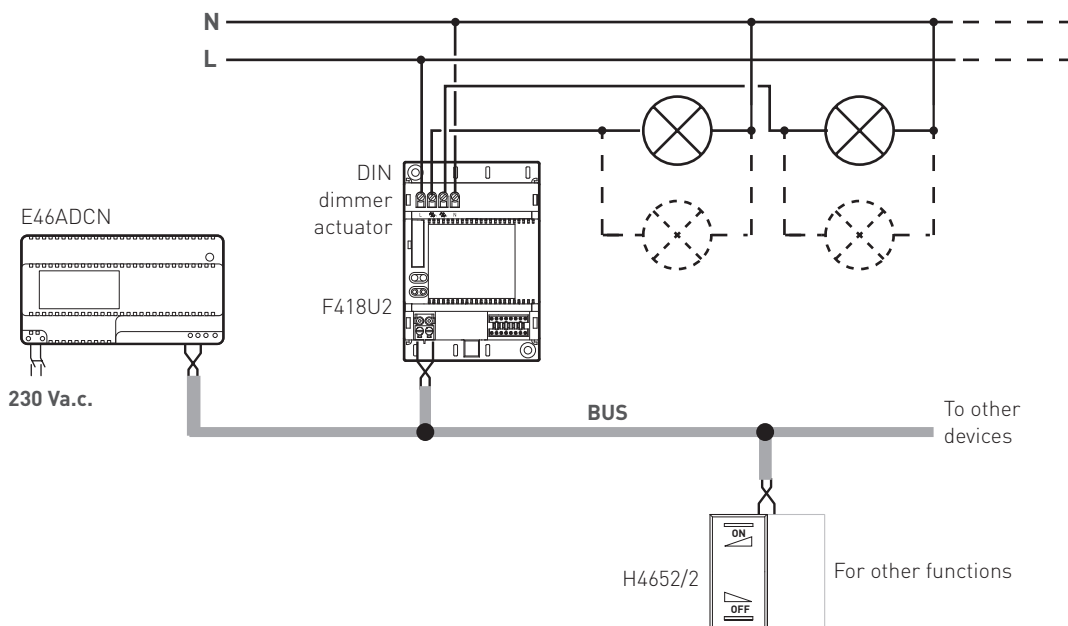

DIAGRAM 7

LIGHTING SYSTEM WITH PRESENCE AND LIGHTING SENSORS - LARGE MEETING ROOM

The SCS 1-10 V dimmer, item BMDI1002, manages all the room lighting circuits: switching on/off the lamps of the screen (circuit 2) and the blackboard (circuit 3), and adjusting the general lighting of the room (circuit 1).

The SCS double technology sensor, item BMSE3003, configured in ECO mode, is installed at the centre of

the room for optimum detection, and automatically disables the general lighting of the room (circuit 1) based on the detection of presence and the level of natural light.

It is also possible to manually adjust the light using one of the 3 module SCS control buttons, item H4652/3, installed at the entrance.

The lights of the screen (circuit 2),

the blackboard (circuit 3) and the general lights (circuit 1), are managed using the 3 module SCS control, item H4652/3.

The shutters (circuit 5, 6 and 7) and the screen up and down control (circuit 4) are controlled by three SCS actuators, item F411U2, and adjusted using the special SCS control, item H4651M2.

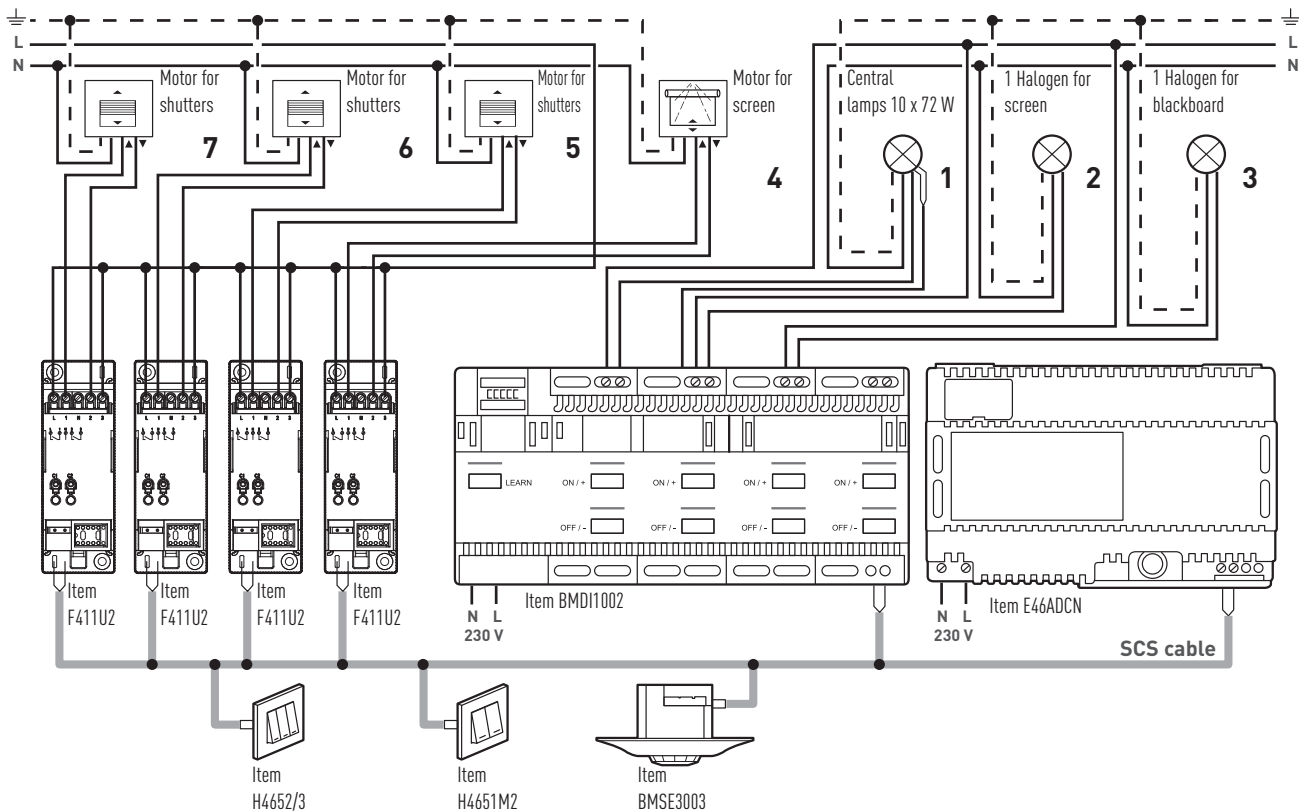

Warning:

- To ensure optimum detection, install the double technology ceiling SCS sensor, item BMSE3003, at the centre of the room; install the three module SCS control, item H4652/3; install the special SCS control, item H4651M2, between the screen and the shutters.
- Install the 2-channel SCS actuators item F411U2 + the 1-10 V 4 channel dimmer, item BMDI1002 + the SCS power supply unit, item E46ADCN, in a cabinet.
- Connect together all the devices using the SCS cable, item L4669, L4669/500, L4669HF.
- Configure sensors, controls and controller using the MyHOME_Suite software.
- The sensor has the following factory settings: delay time 15 minutes, brightness threshold 500 lux, maximum PIR sensitivity and high US. Whenever necessary use the configuration remote control item BMS04001 to change the sensor parameters.

Light and shutter automation system

DIAGRAM 8

LIGHTING SYSTEM WITH PRESENCE AND LIGHTING SENSORS - HALL AND RECEPTION

Each passive infrared ceiling sensor, item BMSE3001, or double technology sensor, item BMSE3003, controls the corresponding zone (circuit 1, 2 and 3). During the day, the illumination is automatically adjusted based on presence or movement, and the

amount of natural light: sensors are configured to keep a 500 lux level in the reception and a 100 lux level on the staircases.

The light can also be switched on using the touch screen, item H/LN4890.

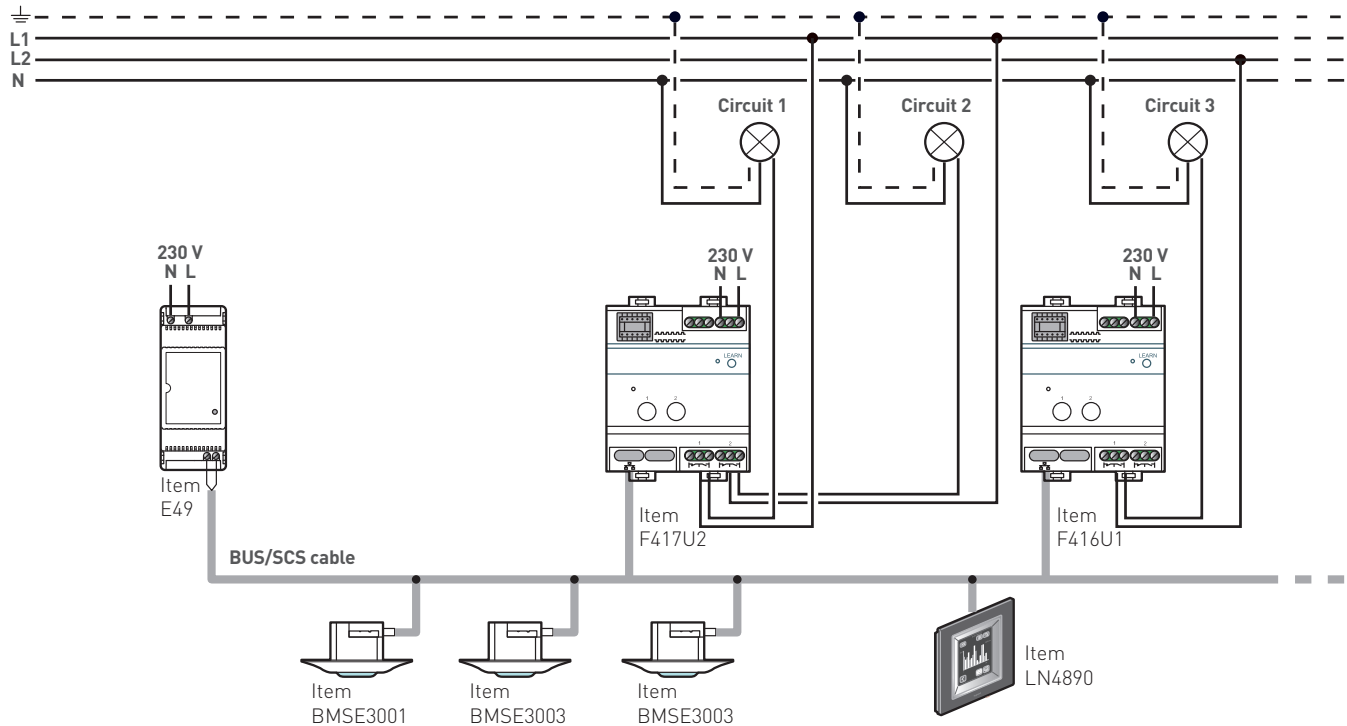

1. Install the double technology or passive infrared SCS ceiling sensors, items BMSE3003 and BMSE300, at the centre of each of the areas to control.
2. Install the SCS power supply unit, item E46ADCN, and the SCS dimmers, items F417U2 and F416U1, in the hall patch cabinet.
3. Install the SCS touch screen, item LN4890, on the wall.
4. Connect all the devices together using the SCS cable, item L4669, L4669/500, L4669HF.
5. Configure all the installed devices using the MyHOME_Suite software.
6. The sensors have the following factory settings: delay time 15 minutes, brightness threshold 500 lux, maximum PIR sensitivity and high US. Whenever necessary use the configuration remote control item BMS04001 to change the sensor parameters.



CONTENTS

MyHOME_Up – Temperature control

General features 70

General rules for installation 76

Wiring diagrams 78

GENERAL FEATURES

Temperature control

The MyHOME temperature control system includes the following devices:

- Probes with and without display
- Actuators

With the installation of the MyHOMEServer1 gateway, the system can also be managed using the HOMETOUCH touch screen, or the Smartphone with the **MyHOME_Up** App. IT is also possible to define programs for the activation of the heating system based on custom profiles.

With the integration of the Driver manager, item F459, it is possible to manage third-party heating and cooling systems using the mentioned devices.

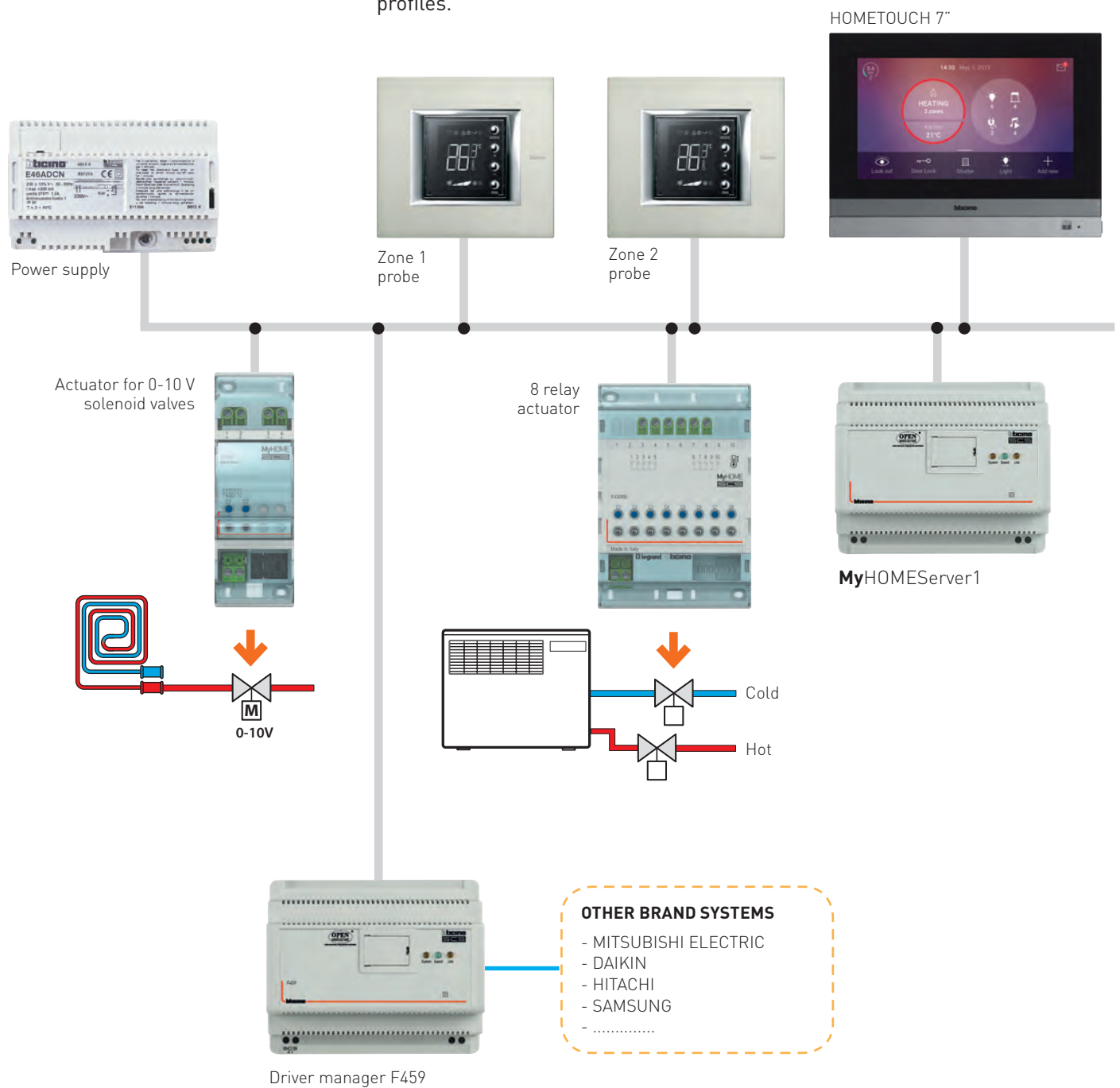

THE PROBES

Probe with display

Fitted with front controls for the selection of the desired temperature and of the operating mode: automatic, manual, preset Eco, comfort, Antifreeze-thermal protection and OFF.

In systems with fan-coil, it is also possible to set the fan speed, and it can be used in mixed systems with both heating and cooling functions. It can be connected to a NC/NO window contact, useful for changing the operating modes based on the status (open or closed) of the window itself.

It is possible to automatically switch OFF the heating if a window is opened in a room managed by the probe. This condition, notified by the opening of the NC type contact, is detected by the probe, which transfers the information to the temperature control system, for the appropriate actions. Living Now probes, item KW/KG/KM4691, are internally equipped with a humidity probe, the measured value of which can be used for advanced applications possible thanks to the integration with third-party systems through Driver manager, item F459.



Probe item KG4691

Basic probe without display

Device for the installation of junction boxes, to be combined with an external temperature sensor, item 3457, for the measurement of the room temperature in the 0 - 40 °C range.

In addition to the SCS clamp used for connection to the SCS bus, and the PROBE clamp for the connection of the external temperature sensor, the probe also has a REMOTE clamp for connection to a remote contact

for different applications (e.g.s to change the operating mode when a window is open, and to change the operating function...).

The probe is also equipped with a mechanical pushbutton for the configuration of the device and 2 LEDs, one red and one green, which provide information on the correct installation and configuration of the device, and the status of the temperature control zone.



Basic probe item 3454

Probe without display

Flush mounted probe to measure the temperature between 3 - 40°C. The device has no temperature adjustment knobs, which makes it suitable for installation in public places /small service sector.

It can be used with slave probe configuration for operation in conjunction with the probe with display, item4691, or as master probe.



SLAVE probe item HC4693

GENERAL FEATURES

Temperature control

THE ACTUATORS

Manufactured for installation in DIN switchboards, these devices control the solenoid valves and the pumps of the temperature control system.

The range is below:



Actuator with 2 contacts item F430/2

With NA contact relay output,

item F430/2 (2 contacts), item F430/4 (4 contacts) and item F430R8 (8 contacts), for the control of ON/OFF valves and pumps. If the system includes fan-coils, the fan speed can also be adjusted.

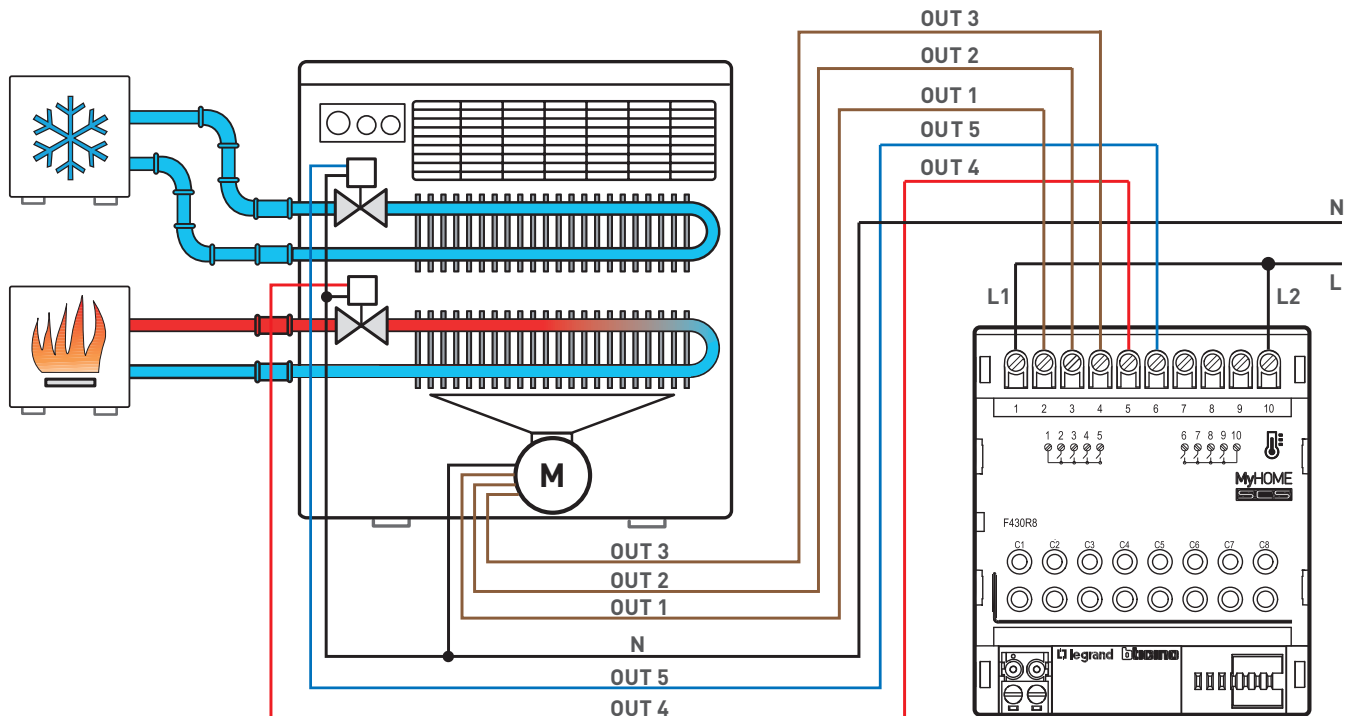

Use of the F430/8 actuator, for the control of a 4-tube and 3-speed fan-coil.

With output voltage 0-10 V

item F430R3V10 (also with 3 NC contacts) and item F430V10, for the control of proportional solenoid valves, type 0-10.

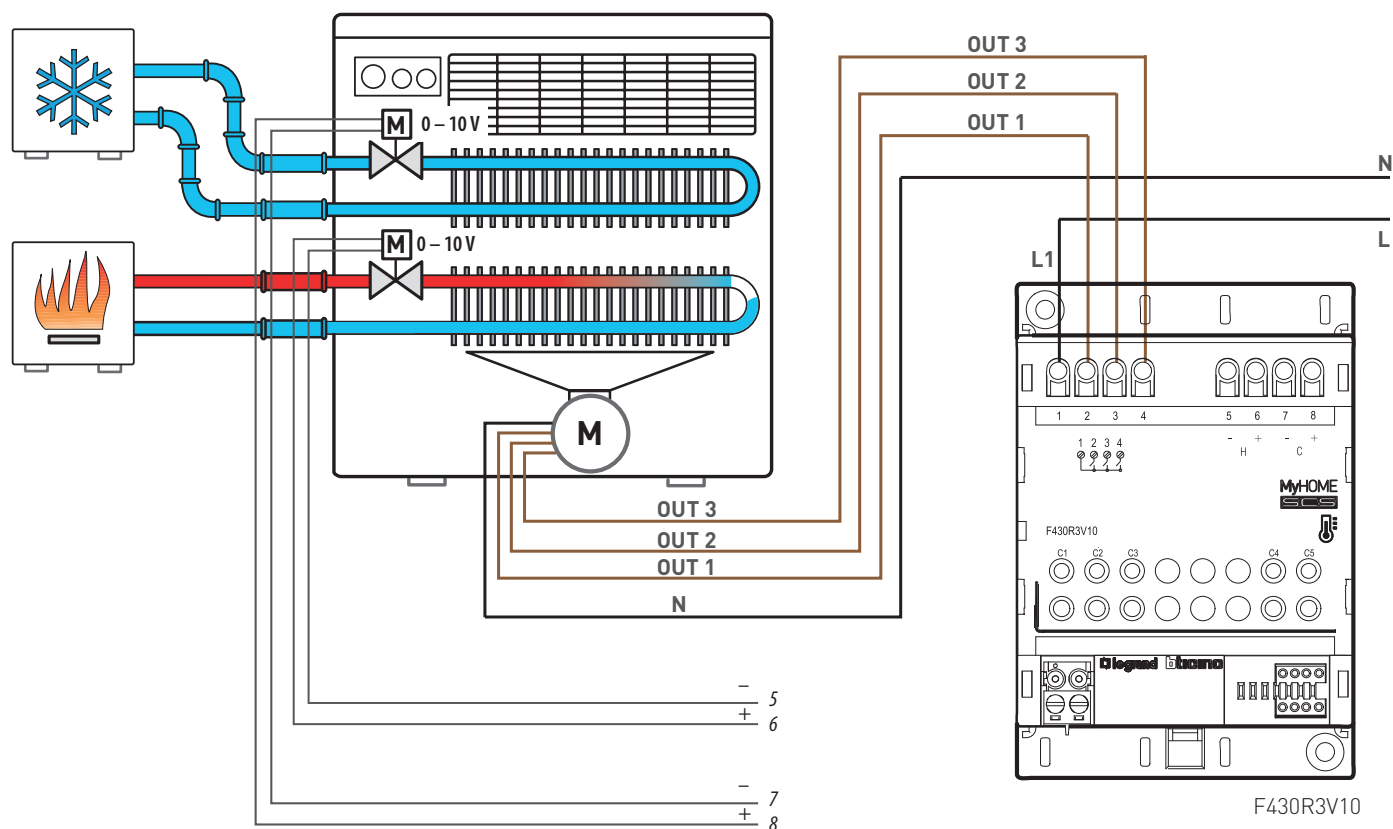

Use of the F430R3V10 actuator for the control of one 4-tube fan-coil with 0-10 3-speed valves.



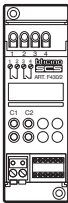
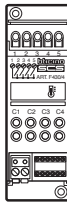
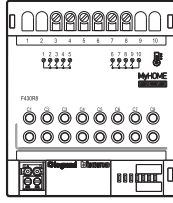

GENERAL FEATURES

Temperature control

SELECTION OF THE DEVICES BASED ON THE SYSTEM TO CONTROL

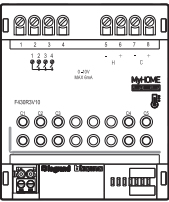
		Actuators			
		 F430/2	 F430/4	 F430R8	
VALVES	ON/OFF	●	●	●	
	OPEN/CLOSE	●	●	●	
	3 POINTS			●	
	0-10V				
FAN-COIL	2 ON/OFF TUBES		●	●	
	4 ON/OFF TUBES			●	
	2 TUBES 3 POINTS			●	
	4 TUBES 3 POINTS			●	
	2/4 TUBES 0-10V				
ELECTRICAL HEATING		●	●	●	
CLIMAVENETA					
MIXED ON/OFF + FAN-COIL					

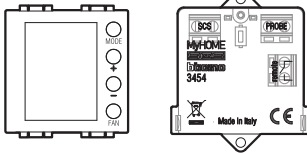
Note 1): Changing the speed using the probes is not possible

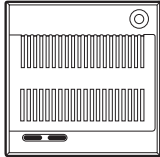
				Probes	
					
F430R3V10	F430V10	H4691 LN4691 KW4691 KG4691 KM4691	3454	SLAVE PROBE HC/HS4693 L/N/NT4693	
			●	●	
			●	●	
			●		
	●		●		
			●	●	11
			●	●	11
			●		
	●		●		
			●	●	11
			●	●	11
			●		

GENERAL RULES FOR INSTALLATION

Temperature control

SIZING OF THE SYSTEM

When sizing the system, check the absorption of the devices to ensure correct system operation. With absorption levels below 600 mA, it will be possible to use compact power supply E49. With absorption levels between 600 and 1200 mA, power supply E46ADCN must be used.

For the current absorption of the device see its technical data sheet.

The length of the cable must also be considered, complying with the following rules:

- The connection length between the power supply and the furthest device must not exceed 250 m.
- The total length of the connections must not exceed 500 m (cable extended).
- For optimum division of the currents on the bus line it is recommended that the power supply is installed in an intermediate position.

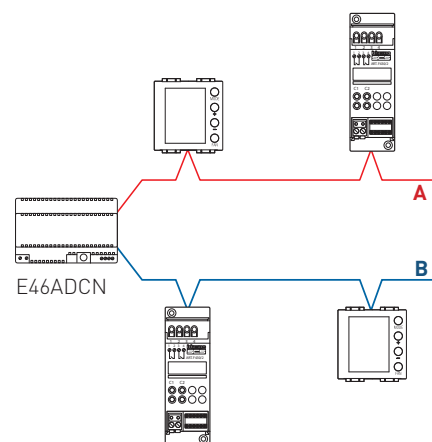

With power supply E46ADCN:

A = 250 m max

B = 250 m max

A + B = 500 m

Note: if a UTP5 cable is used in alternative to the L4669 BUS cable, distances are halved.

SYSTEM PHYSICAL EXPANSION

Particularly extended systems, or systems with overall device absorption exceeding 1200mA supplied by power supply E46ADCN, can be split into several sections powered with their own power supply unit and connected to each other in "physical separation" mode using the F422 interface configured in "physical expansion" mode.

When sizing the system, consider that:

- It is not possible to connect two interfaces in parallel on the same BUS;
- It is possible to install up to 4 interfaces to split the system into 5 separate sections.

For further indications refer to the technical data sheet of the F422 interface, available at bticino.com

NOTE: devices are automatically configured by the MyHOMEServer1 web server.

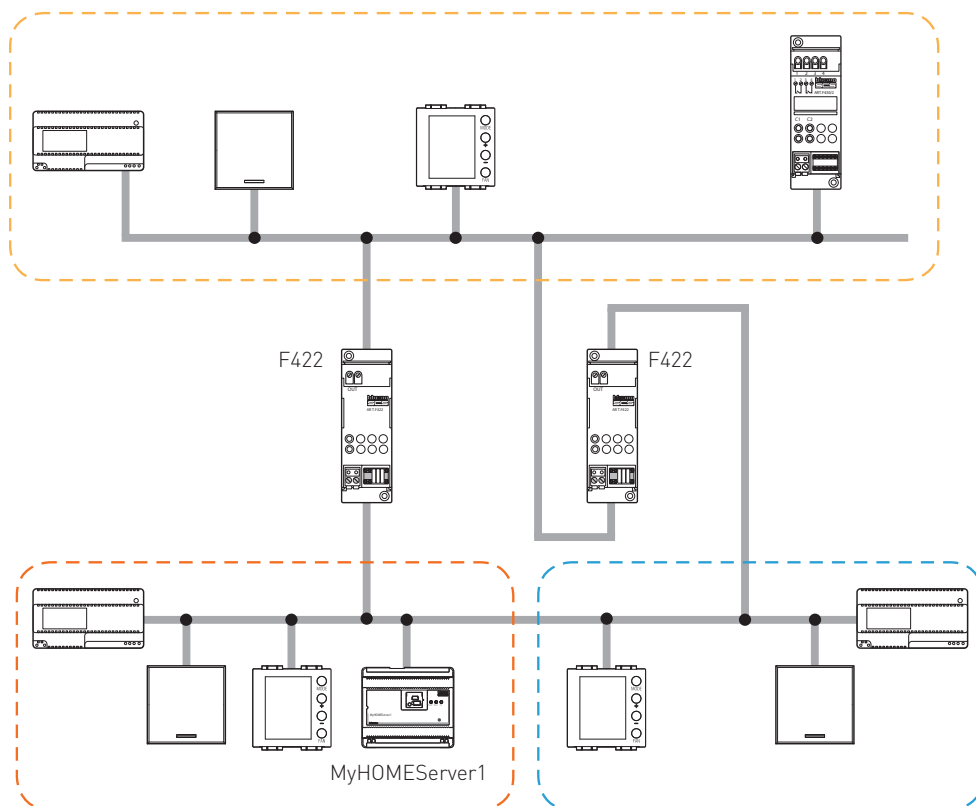

Example of temperature control system integrated with the light and shutter automation system.

ASSOCIATION OF THE DEVICES

This operation defines:

- the logic link between a probe and the corresponding actuator that must be managed;
- the operating mode of probes and actuators based on the type of temperature control system to manage.

As for the light and shutter automation system, this function is carried out when putting the system into operation and using the MyHOMEServer1 web server and the MyHOME_Up smartphone App.

For the list of the devices compatible with this mode, refer to the APPENDIX section at the end of the guide.

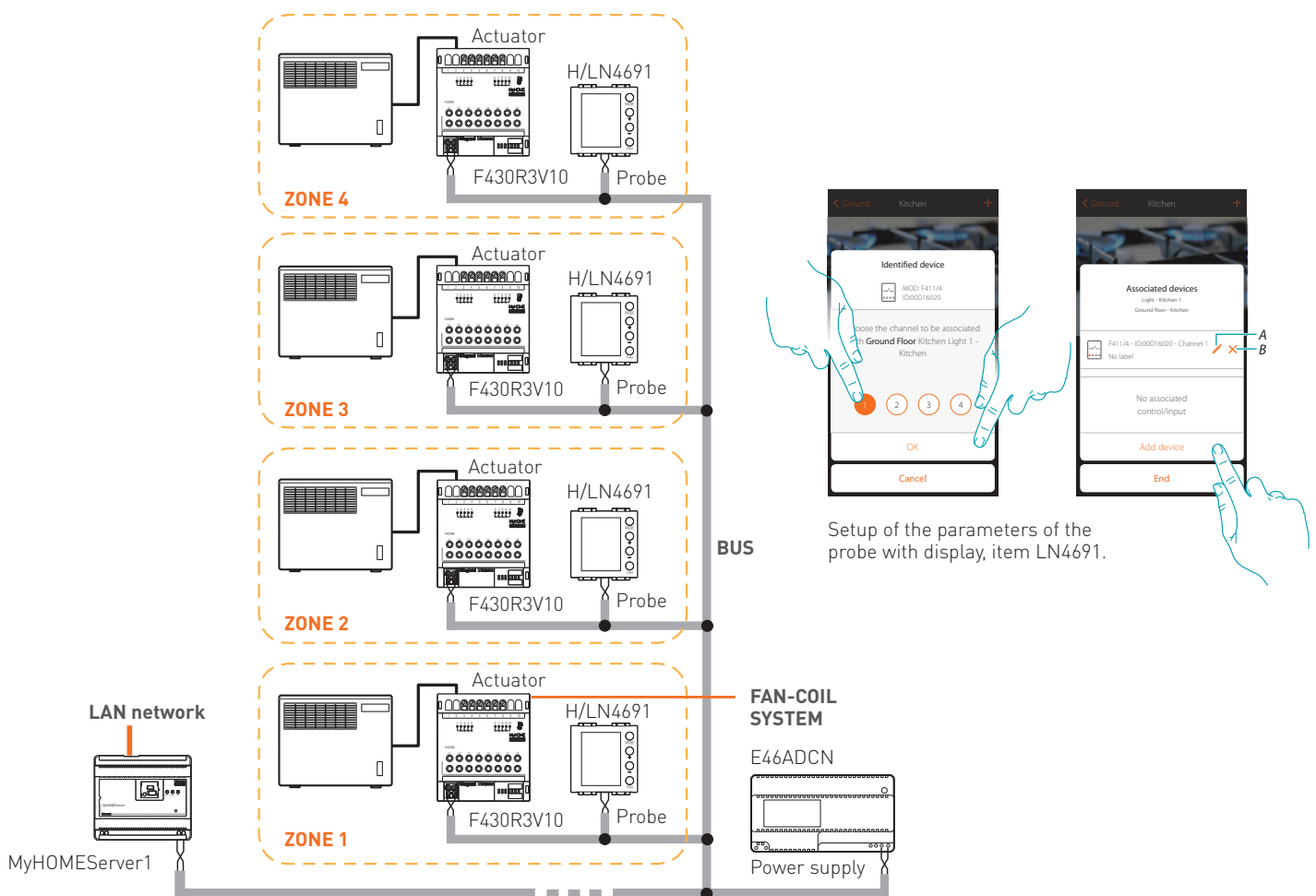

Setup of the parameters of the probe with display, item LN4691.

Temperature control

DIAGRAM 1

4 ZONE VILLA - HEATING BY MEANS OF RADIATOR WITH 0-10 V SOLENOID VALVES

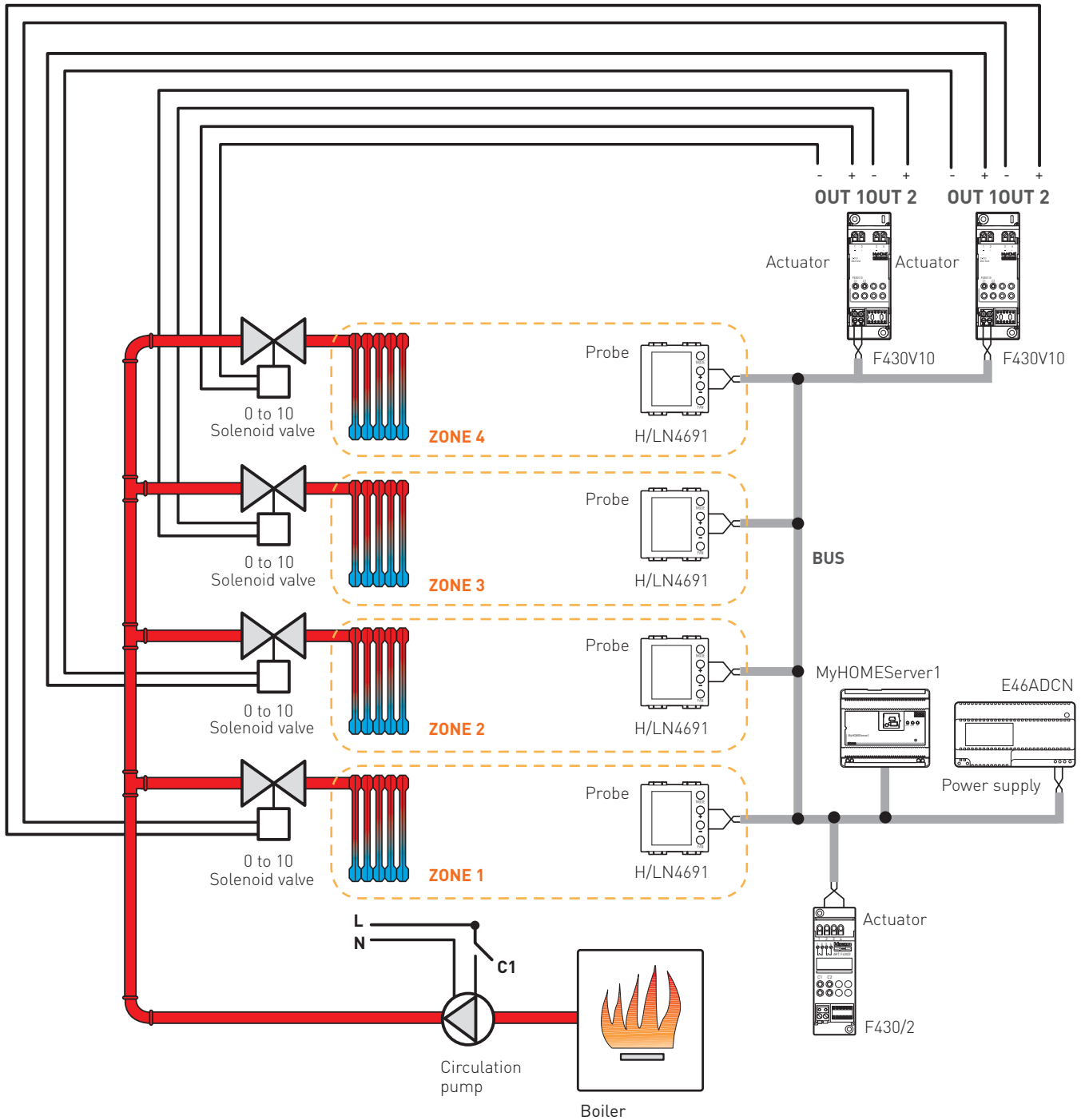

WARNING: The diagrams, showing Axolute and Livinglight, also apply, when possible, to MyHOME_Up products, Living Now series. For further information, see the Technical sheets of every item available in the bticino.com site.

DIAGRAM 2

4 ZONE VILLA - HEATING BY MEANS OF RADIATORS WITH ON/OFF SOLENOID VALVES

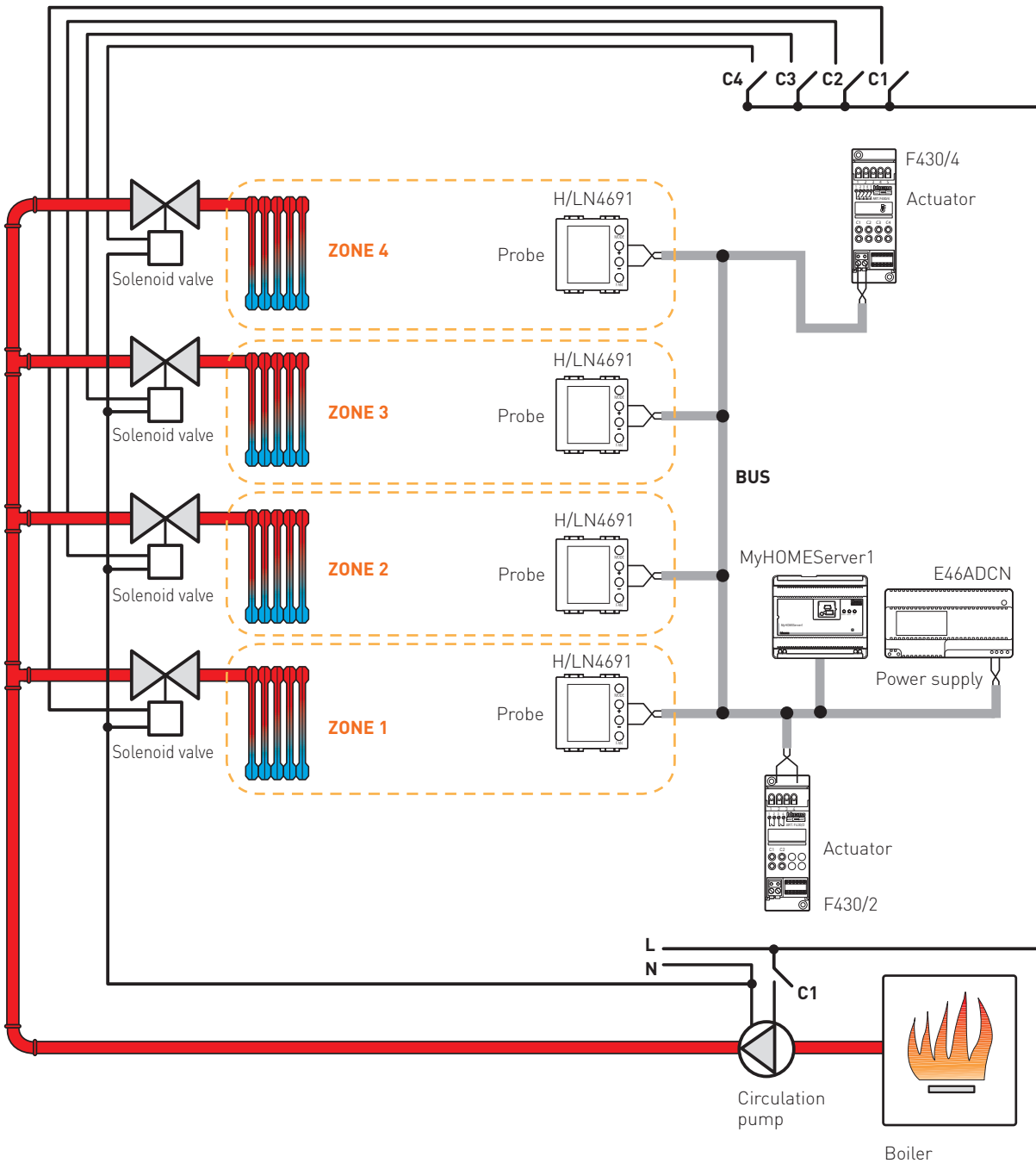

Temperature control

DIAGRAM 3

4-ZONE VILLA - HEATING AND COOLING WITH 4-TUBE FAN-COILS, WITH 0-10V SOLENOID VALVES OR WITH 0-10 SPEED ADJUSTMENT.

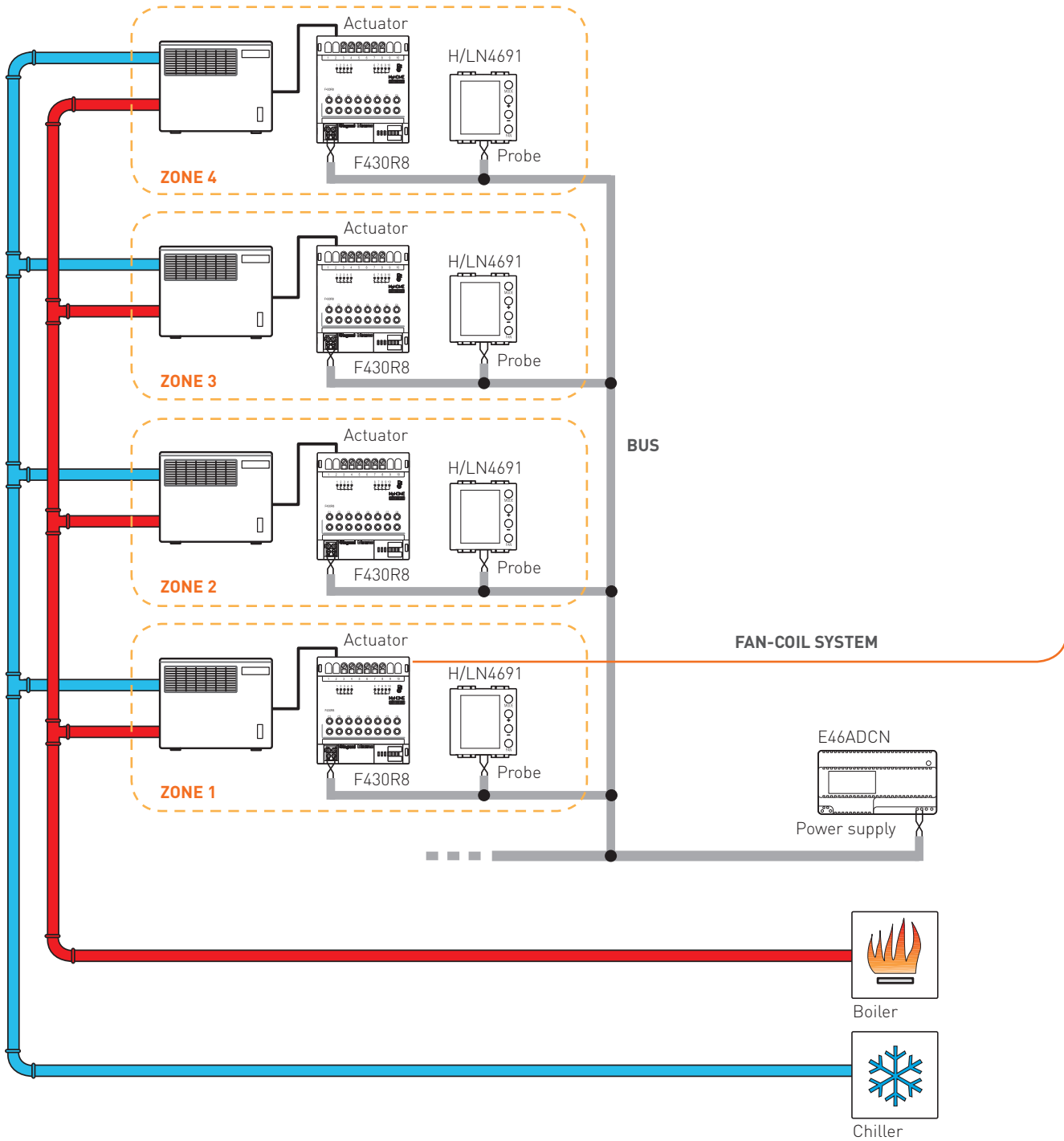

Note: 0-10V valves are not managed in proportional mode, but in ON-OFF mode

Actuator connection

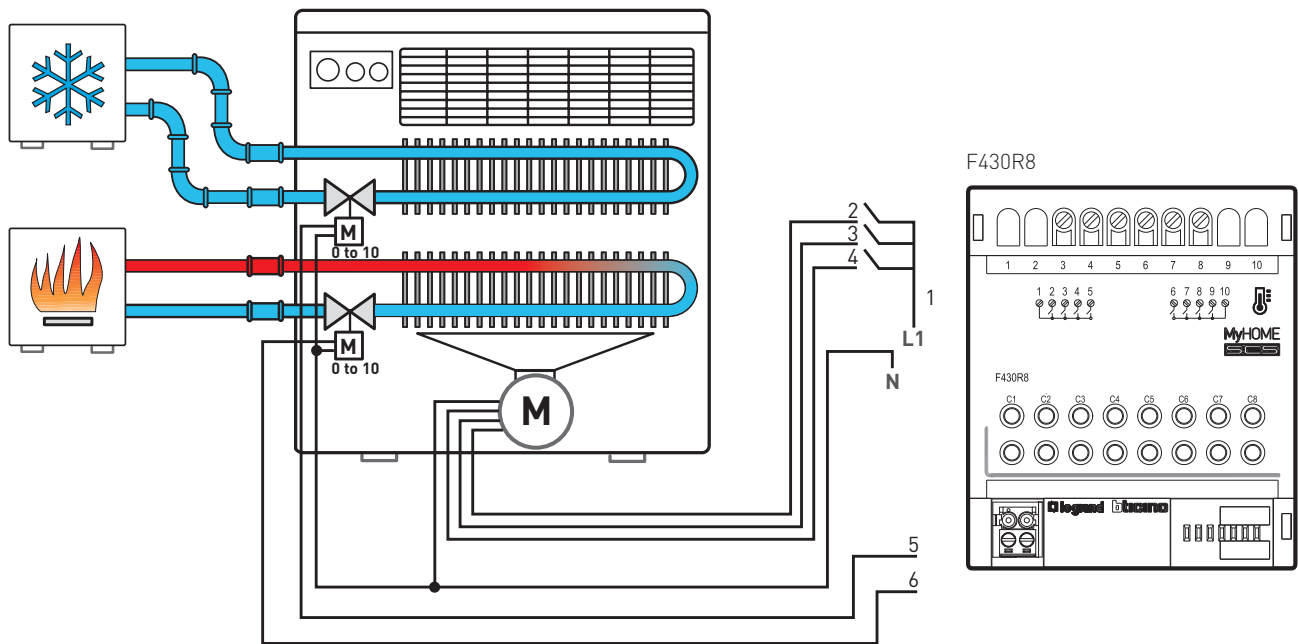

Variation for the connection of a 4-tube fan-coil with 0-10 V speed adjustment
 - use of two 0-10 V outputs (set LOAD = 3 in case of physical configuration).

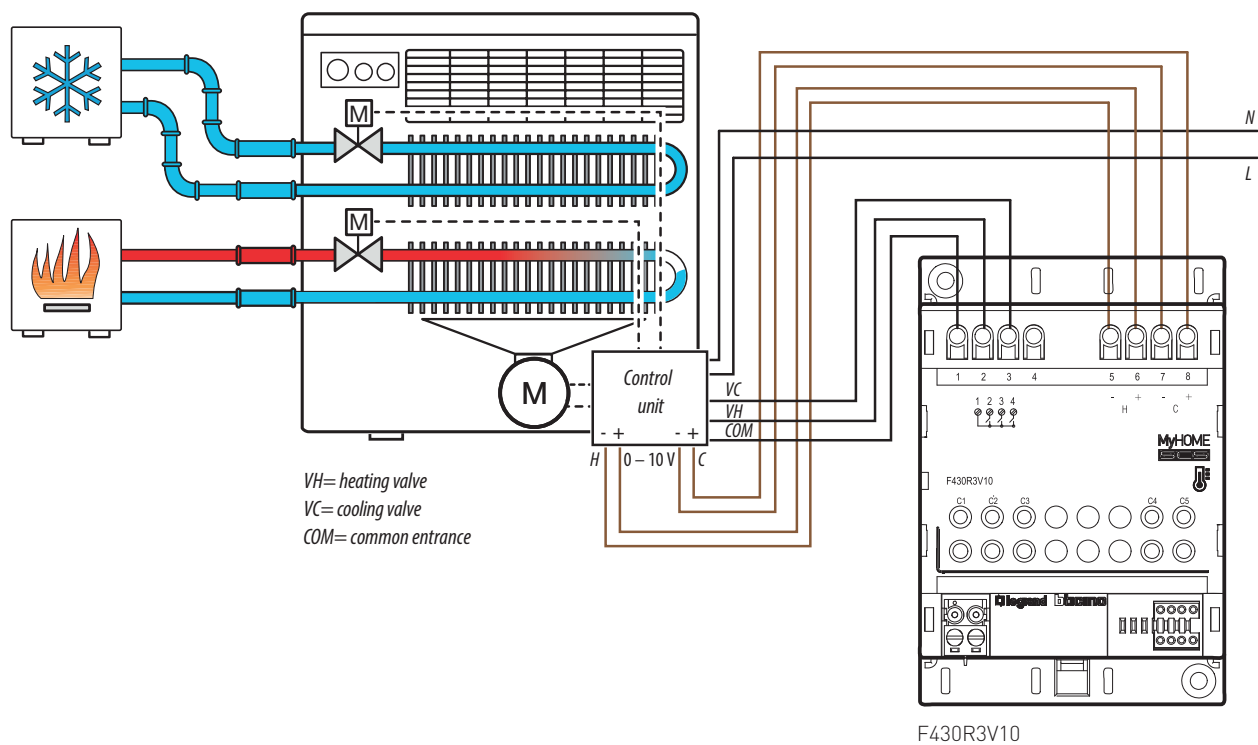

F430R3V10

Temperature control

DIAGRAM 4

3-ZONE VILLA - INTEGRATION OF THE TEMPERATURE CONTROL SYSTEM WITH RADIANT PANEL HEATING SYSTEMS AND DAIKIN VRV COOLING (IP PROTOCOL)

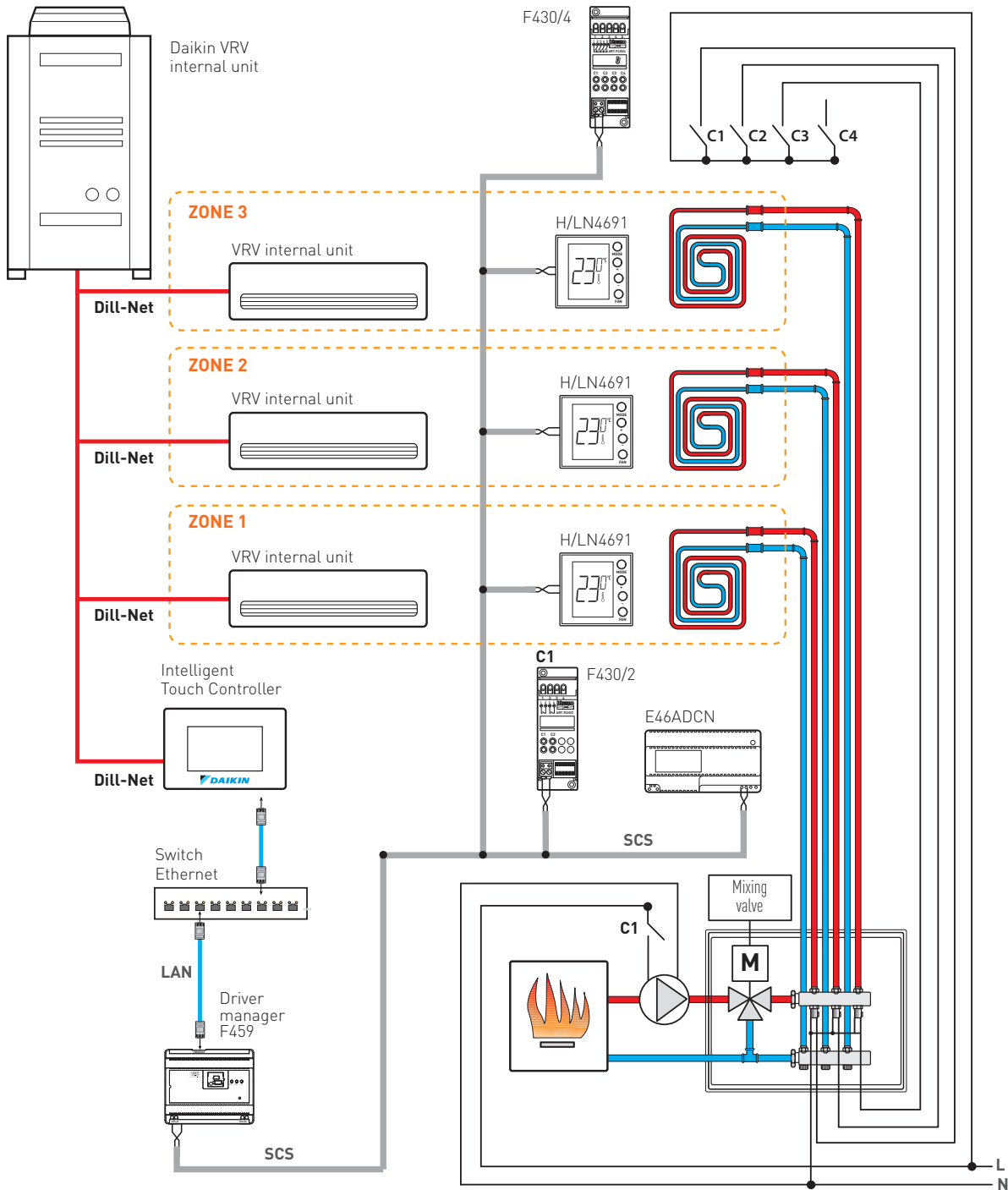

In these systems the Daikin local controllers must not be installed.



CONTENTS

MyHOME_Up - Load control and consumption display

General features	84
Wiring diagrams	89

GENERAL FEATURES

Management and load control system

The load control Management system manages the maximum power used, by automatically disconnecting the least important appliances in case of overload.

OPERATION

The control unit measures the power absorbed by the connected loads and compares it with the preselected value (between 1.5 and 18 kW, with tolerance +/- 20%).

Each load to control is associated with an actuator managed by the control unit, which disconnects the load from the network in case of overload.

The load disconnection sequence can be configured during installation; it is possible to manage up to 63 priority levels (actuators).

In the example shown, the oven, the microwave and the washing machine represent the loads controlled through actuators, while the refrigerator, the operation of which must never be stopped, is connected to the socket without actuator.

In case of overload, the first appliance that disconnects is the least important one; in this example this is the oven, which has a priority level of **1**.

The microwave is on the other hand the appliance with the highest importance, with priority level 3, and only disconnects after the oven and the washing machine.

The status of the disconnected appliance is displayed on the 7" HOMETOUCH touch screen and on the digital controls, item KW/KG/KM8011, through LED pictograms.

The device can be reactivated using the button of the actuator, using the 7" HOMETOUCH touch screen, and the digital controls, item KW/KG/KM8001.

If after reactivation the overload persists, the control unit disconnects the loads with priority levels **2** and **3**, until the overload situation is resolved,

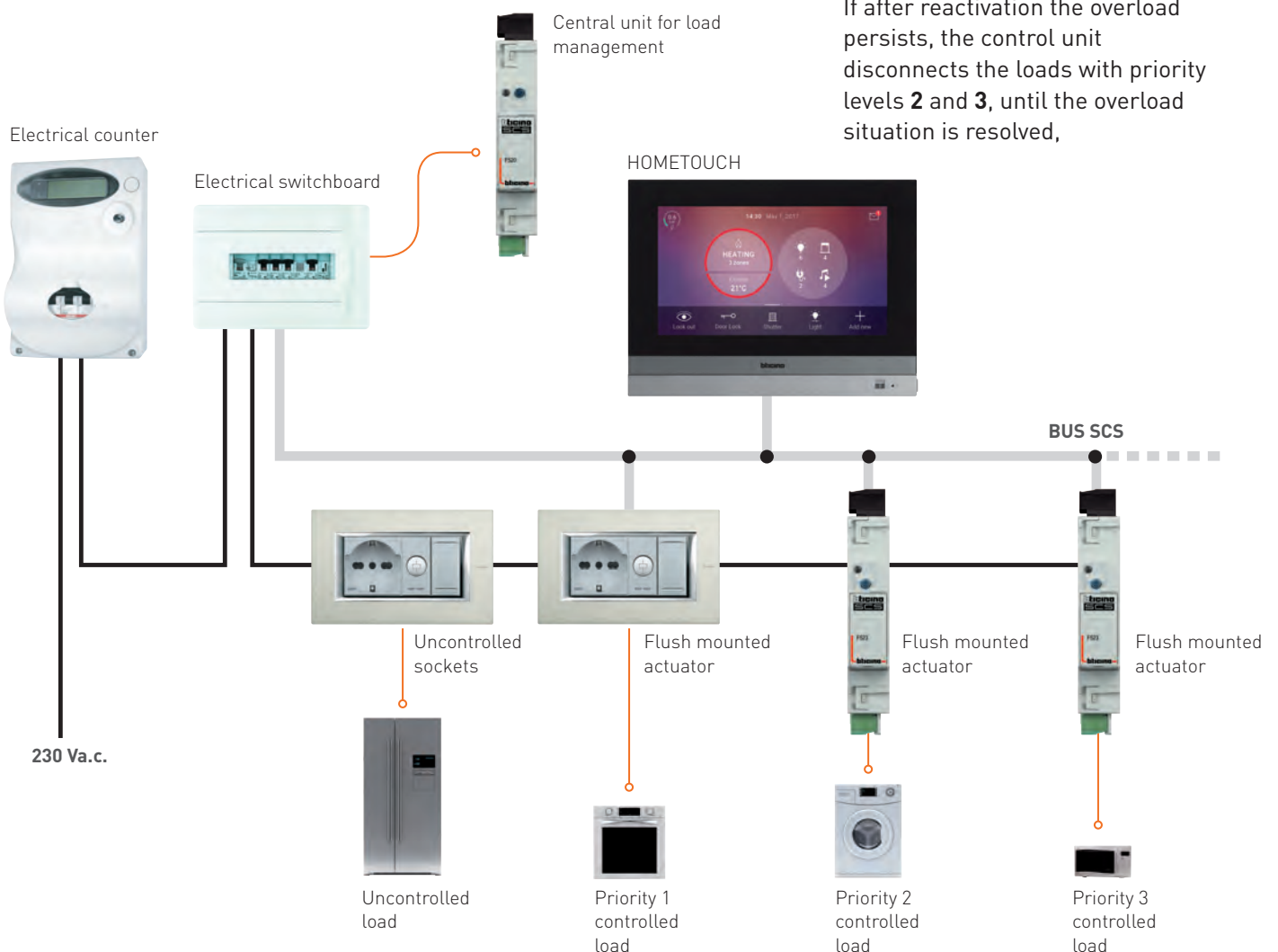

NOTA: the load control management central unit is positioned inside the electrical switchboard.

Consumption display and energy production

An important function offered by **MyHOME_Up** is the possibility of real time display and filing of the home energy consumption data.

The measurement is carried out using toroid electricity meters, item F520. The display is through the Smartphone and the **MyHOME_Up** App.

Photovoltaic panel



Inverters



Electric power meter



Compact power supply



MyHOME_Up App

Load control and consumption display

CONTROL AND MEASUREMENT DEVICES

Electricity meter item F520 with 3 toroid inputs

The device measures up to three separate electricity lines through the corresponding measurement toroids.

The intended processing and accounting functions are:

- Instantaneous consumption or production of maximum 3 lines;
- Instantaneous consumption or production on hourly basis for the last 12 months, on daily basis for the last 2 years, on monthly basis for the last 12 years.

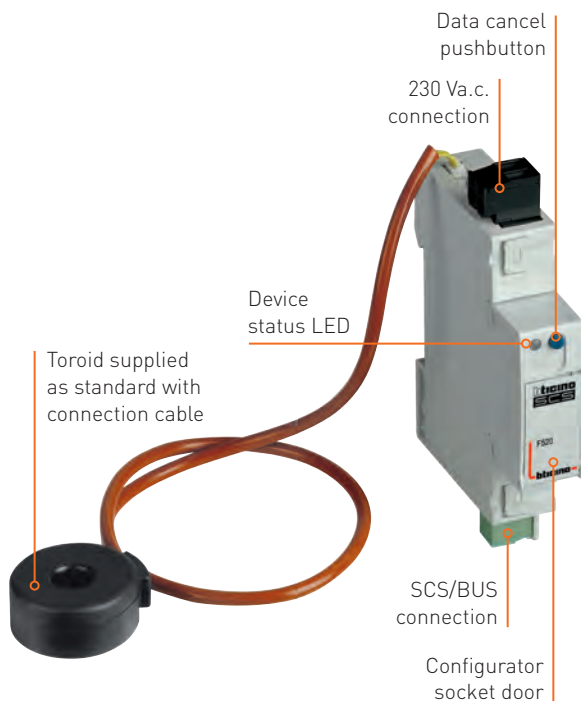

Central unit for load management art. F521

Device for the measurement of the power absorbed by the electric system, and the management of the load management system actuators.

The control unit manages up to 63 appliances or electric loads for each phase, making available the following data:

- instantaneous consumption of the controlled line;
- cumulative consumptions on hourly basis for the last 12 months, on daily basis for the last 2 years, on monthly basis for the last 12 years.

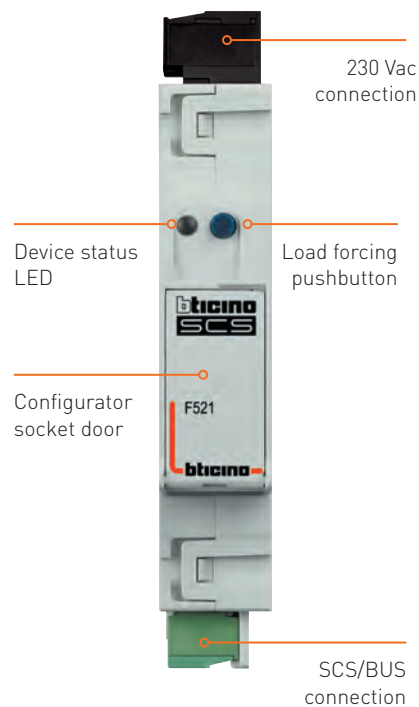

Flush mounted 16A actuator item4672N

Flush mounted device with internal 10A relay for load control management and/or automation.

Load control mode manages the load disconnection priority based on the settings of the load control unit, item F521.

A front pushbutton allows to:

- force the priority of the load during normal operation. In this case the central unit cannot disable the load for 4 hours.
- re-enable a load disabled by the central unit (the duration of this operation lasts for 4 hours, unless the disabling key is pressed manually).

In light automation mode, it carries out all the operational activities that can be configured on the control devices, with the exclusion of shutter control.

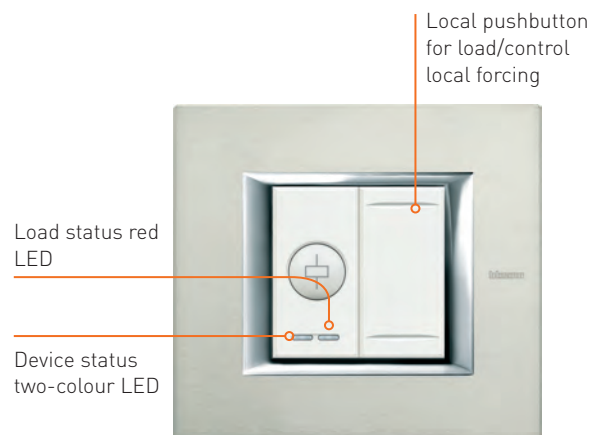

16A actuator with current sensor item F522

Device equipped with 1 10A bistable relay with zero crossing functionality for the load control management and/or automation functions, with the same modes of the flush mounted actuator, item4672N.

The actuator can be used for the measuring of the electricity, as it is fitted with an internal current sensor for the measurement of the consumptions of the controlled load and, in conjunction with the external optional toroid, item 3523, for the measurement of the earth leakage current of the diagnostic system.

16A actuator item F523

Device equipped with 1 bistable relay with zero crossing functionality for the load control management and/or automation functions, with the same modes of the flush mounted actuator, item4672N.

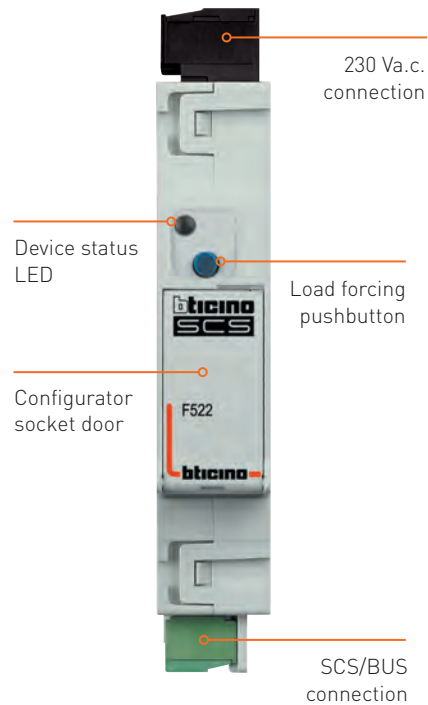

Central unit for load management item **F522**.
The device has a similar construction to actuator **F523**.

DEVICE SELECTION

Available functions	Devices					
	Energy meter item F520	Central unit for load management item F521	Actuator 16A with current sensor item F522	16A actuator item F523	Flush mounted 16A actuator item ...4672N	Living Now Full control item ...8011 and Touch screen HOMETOUCH
Display	●	●	●			●
Load control		●	●	●	●	●
Diagnosis 1)			●			

Note 1): in combination with optional toroid 3523

Load control and consumption display

SIZING OF THE SYSTEM

The maximum number of devices in a system depends on the total absorption of the same and the distance between the point of connection and the power supply. With absorption levels below 600 mA, it will be possible to use compact power supply E49. With absorption levels between 600 and 1200 mA, power supply E46ADCN must be used.

If the system shares the same cable of the Automation/Temperature control system, the calculation of the maximum number of devices must be completed taking into account the general absorption of the same.

For the purpose of the above calculations, refer to the absorption values indicated on the technical data sheets of the devices, available in the on-line catalogue that can be found at bticino.com.

When sizing the system, it is also necessary to consider the length of the cable, complying with the following rules:

- The connection length between the power supply and the furthest device must not exceed 250 m.
- The total length of the connections must not exceed 500 m (cable extended).
- For optimum division of the currents on the bus line it is recommended that the power supply is installed in an intermediate position.

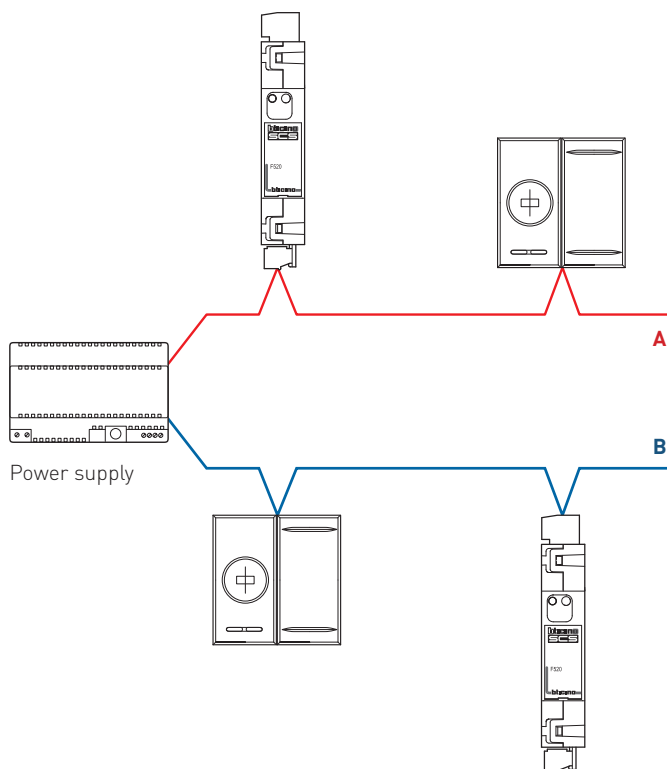

- A** =250 m max
- B** =250 m max
- A + B** =500 m

Maximum current provided by the power supply:
1200 mA for item E46ADCN and 600mA for item E49.

Note: If a UTP5 cable is used in alternative to the L4669 BUS cable, distances are halved.

Management and load control system

DIAGRAM 1 - MANAGEMENT AND LOAD CONTROL

⚠ CAUTION

- A** It is possible to install the following flush mounted 2-module 16A actuators:
 - HC/HS/HD4672N AXOLUTE
 - L/N/NT4672N LIVING/LIGHT/LIGHTECH
- B** The TMG circuit breakers must be selected based on the load absorption.
- C** The IG general circuit breaker (TMG+EARTH LEAKAGE) must be selected based on the general absorption. For better safety and comfort it is recommended to install also the STOP&GO additional device.
- D** Supplied with each F521 is a 3523 toroid for the reading of the current

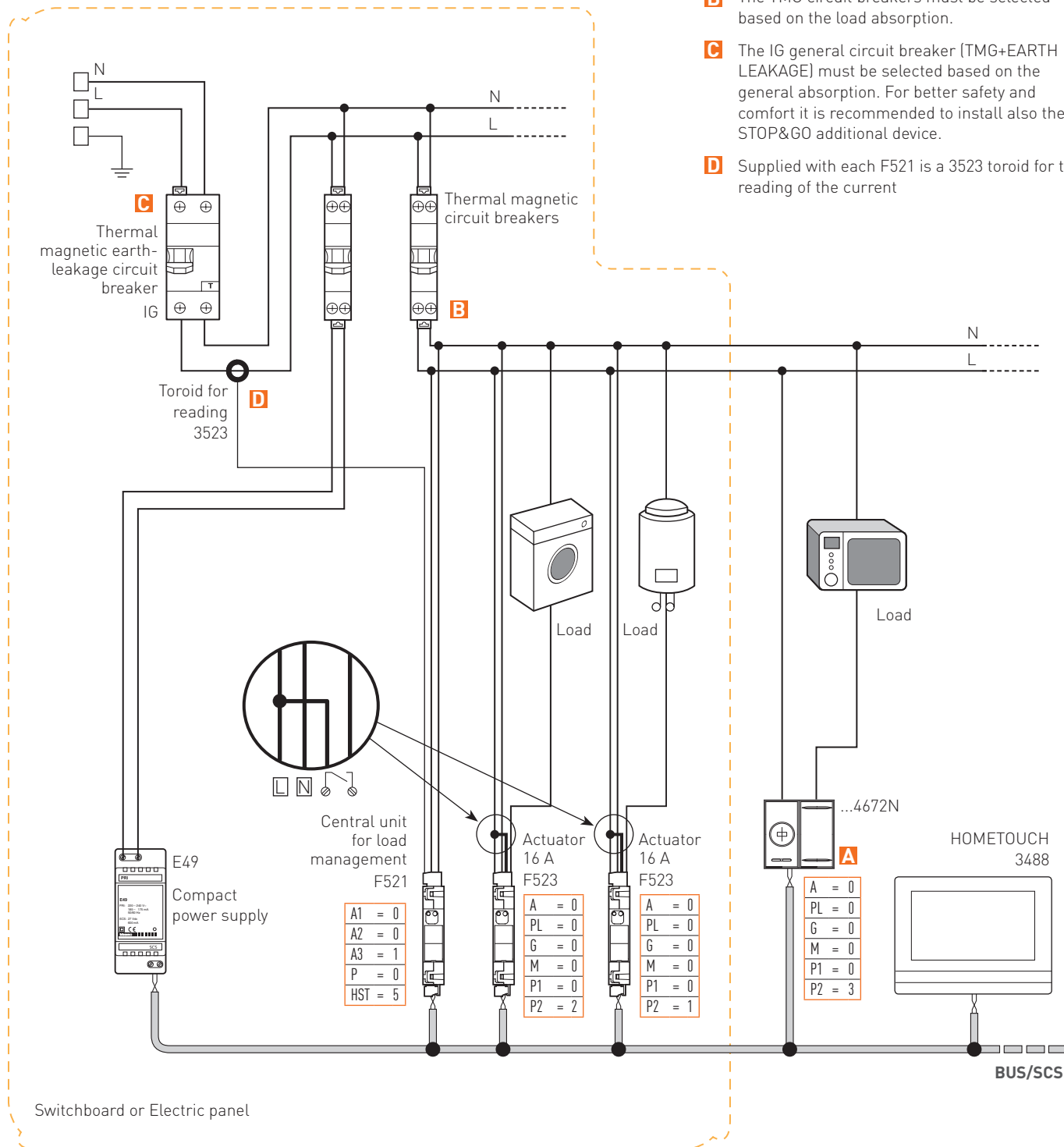

Management and load control system

DIAGRAM 2 - THREE-PHASE LOAD CONTROL MANAGEMENT AND SINGLE PHASE LOAD WITH BUS SCS IN COMMON

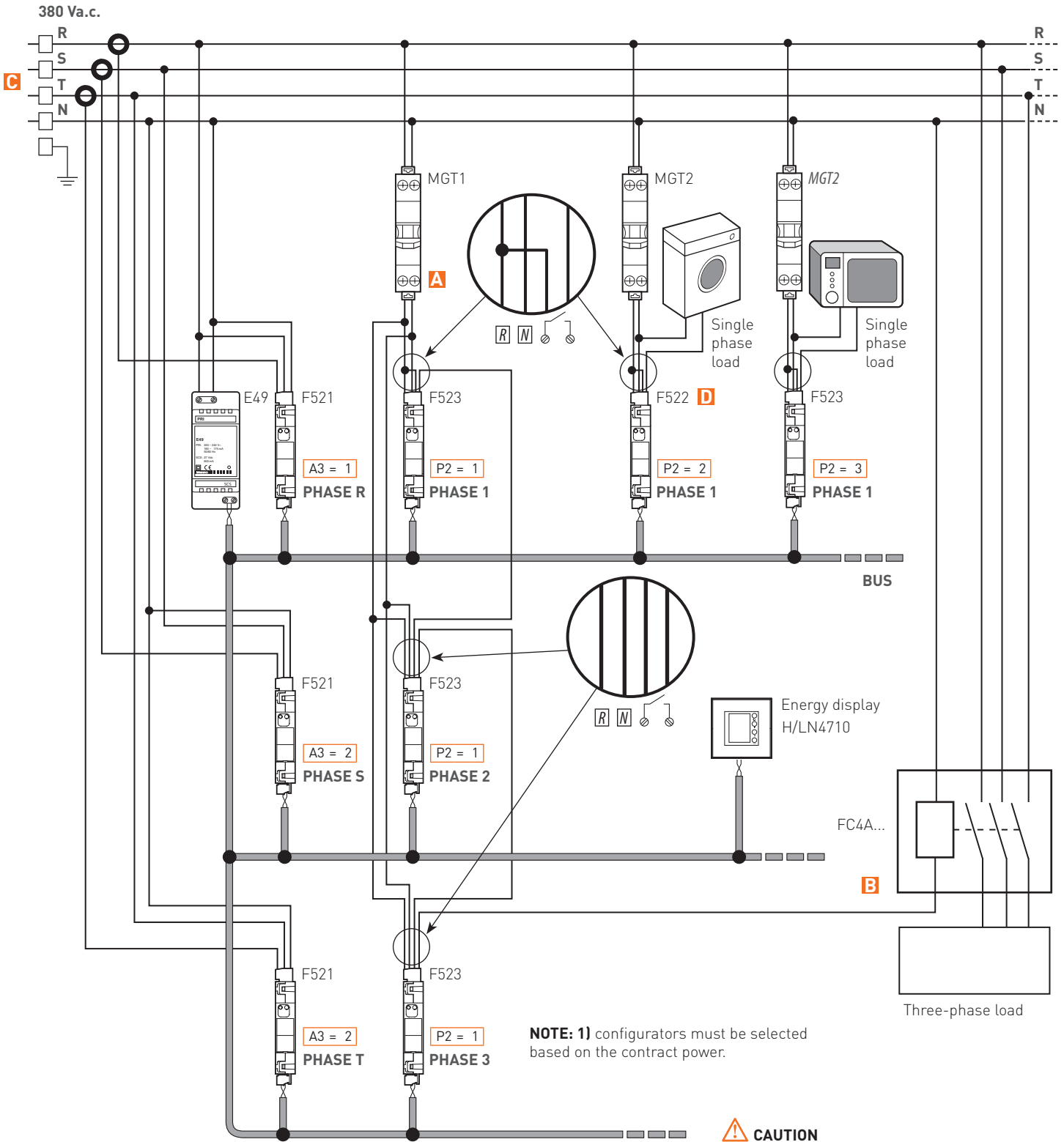

CAUTION

- A** The thermal magnetic circuit breakers must be selected based on the load absorption.
- B** The contactor must be selected based on the load absorption
- C** The three-phase line must be balanced
- D** F522: to be positioned where the single-phase load must be measured



MyHOME_Up - Function integration

GENERAL FEATURES

Function integration

The integration of the various home automation functions allows to set advanced functions that could not be possible with a traditional system.

For example it is possible to:

- create advanced functions, such as switching on all the lights following an intrusion alarm;
- create scenarios for the simultaneous activation of several devices of the **MyHOME_Up** system for the creation of comfort situations.

The integration also allows to control all the home automation functions through central control devices, such as the HOMETOUCH Touch Screen, or a Smartphone with the **MyHOME_Up** supervision App. With **MyHOME_Up** it is possible to have two types of integration:



- 1. Integration of two or more MyHOME_Up functions**, such as the light automation system with the temperature control system, or the load management system.
- 2. Integration of two or more MyHOME_Up functions with other BTicino and/or third party systems**, possible using the LAN network and the TCP-IP communication protocol, or dedicated interfaces. An example is represented by the integration of the Automation system with the radio-wired Burglar Alarm system, or with the NUVO digital audio system. They can also be integrated with third-party products, such as air conditioning systems, Philips Hue lamps, etc...

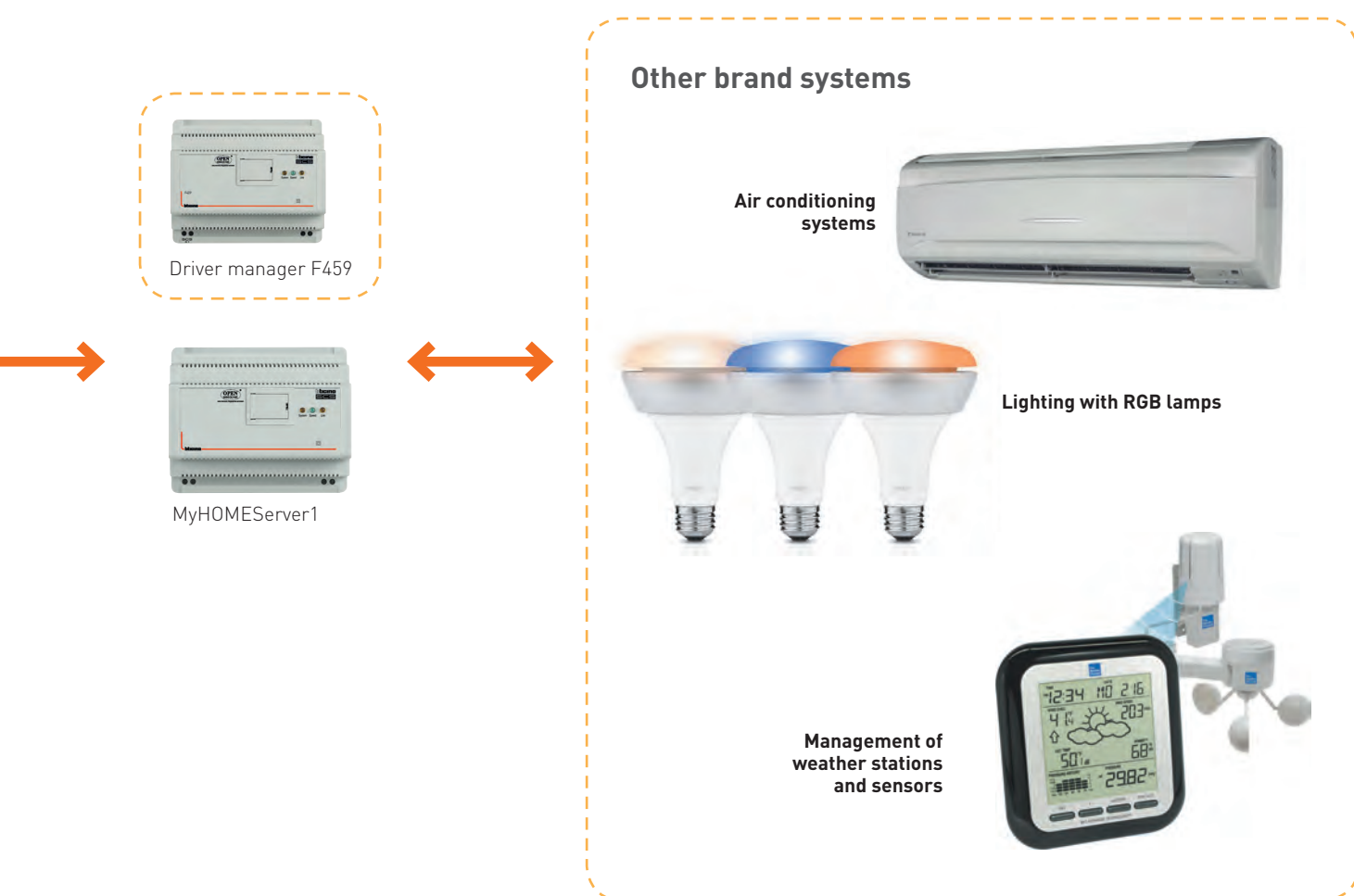

GENERAL FEATURES

Function integration

INTEGRATION OF LIGHT AUTOMATION, LOAD MANAGEMENT, CONSUMPTION DISPLAY AND TEMPERATURE CONTROL SYSTEMS

The integration is achieved without the use of special interfaces, as the devices share the same BUS cable and electric power supply.

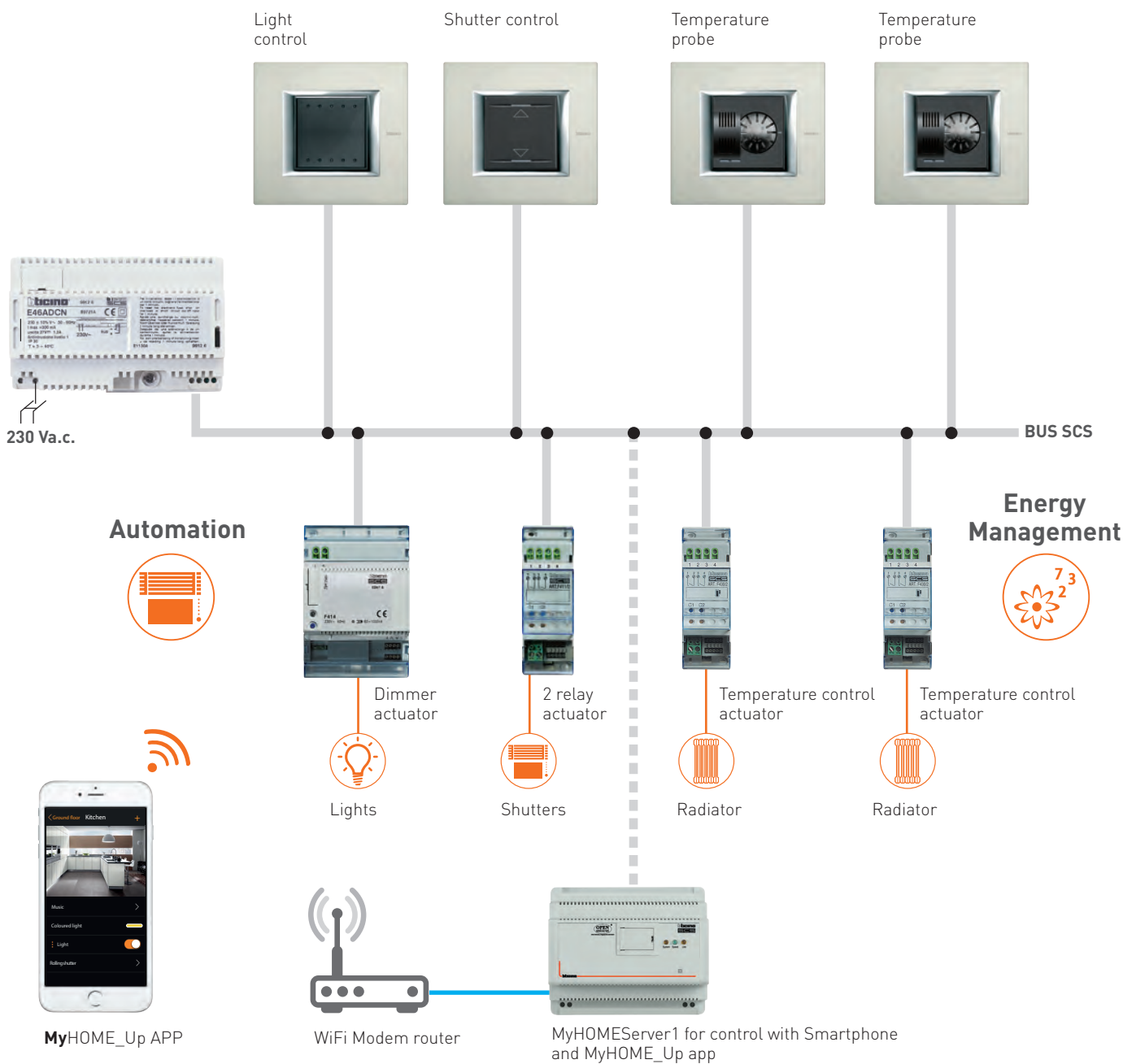

“Physical separation” mode

In case of need of splitting the system in order to achieve the current absorption values, or to keep them separate, interface F422 must be used in “physical separation” mode.

With this mode, each system can be connected both to the OUT and the IN clamp of the F422 interface used to keep the corresponding BUS separate, and the electric power supplies independent.

The interface operating mode will be set automatically from MyHOMEServer1 the first time the system is switched on.



F422 interface

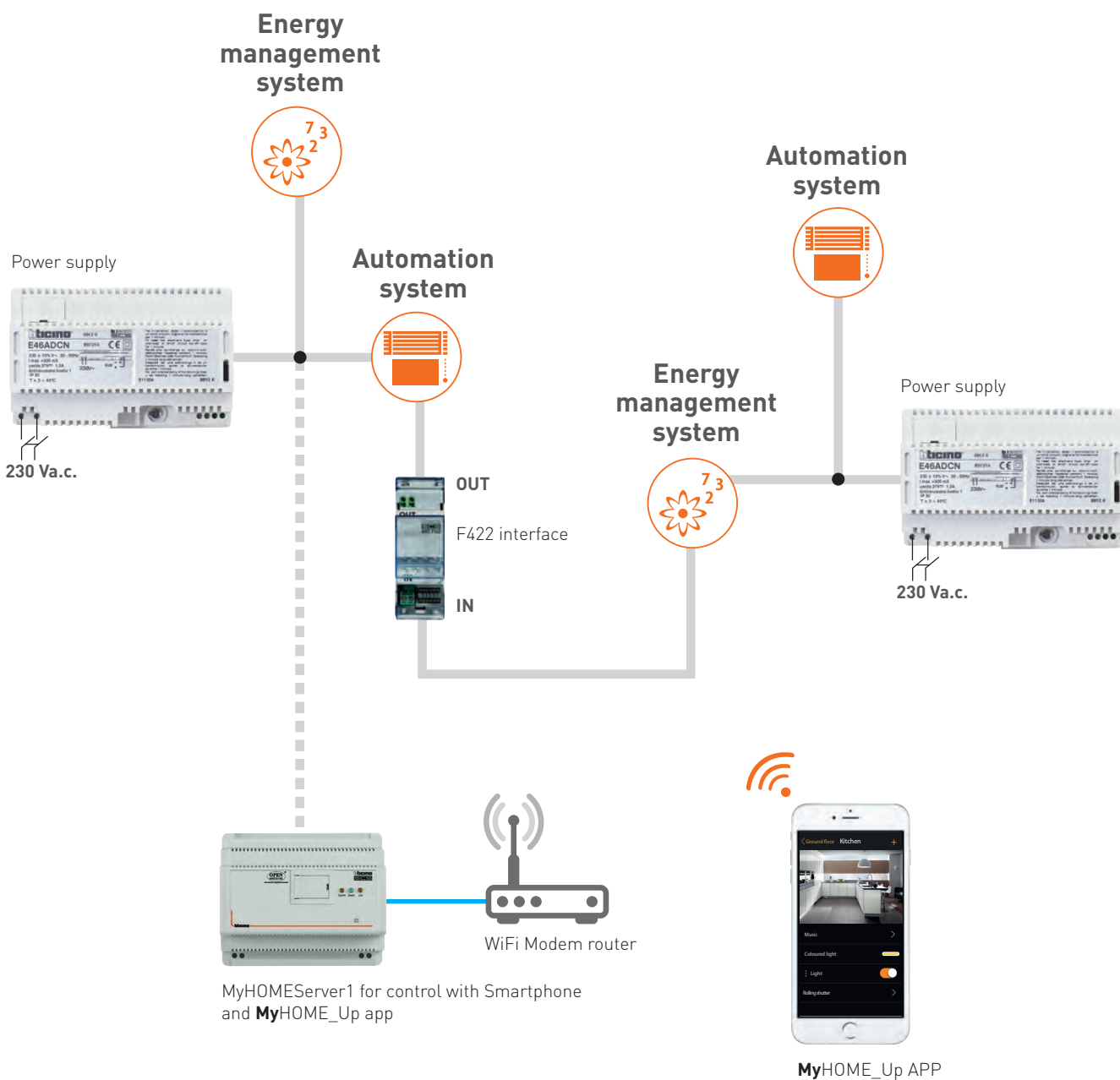

Function integration

INTEGRATION OF MyHOME_Up SYSTEMS WITH BTICINO AND/OR THIRD PARTY SYSTEMS

MyHOME is an open system that can be easily integrated, without any modifications, with the best technologies, and with systems and devices of other manufacturers. The integration is completed in the following ways:

- A.** Using the F422 interface or the HOME TOUCH touchscreen, for the integration of the automation and temperature control system with the video door entry system.
- B.** Using the MyHOMEServer1 gateway based integration platform.
- C.** Using the MyHOME_Link integration platform based on the use of the F459 Driver manager and the TCP/IP communication protocol.
- D.** Using integration devices with different communication protocols, such as DALI, etc.;
- E.** Developing API based applications supplied by BTicino through the “Works With Legrand” program.

A.1 Use of interface item F422

For the integration of the two systems shown, interface F422 must be configured in “galvanic separation” mode (configurator 0 in the MOD position);

This device makes it possible to use some Automation devices for the activation of Video door entry functions, such as switching a light or a camera on.

For more information, see the CONNECTION DIAGRAMS - VARIATIONS sections of the design guide for BTicino 2 wires audio and video door entry systems.

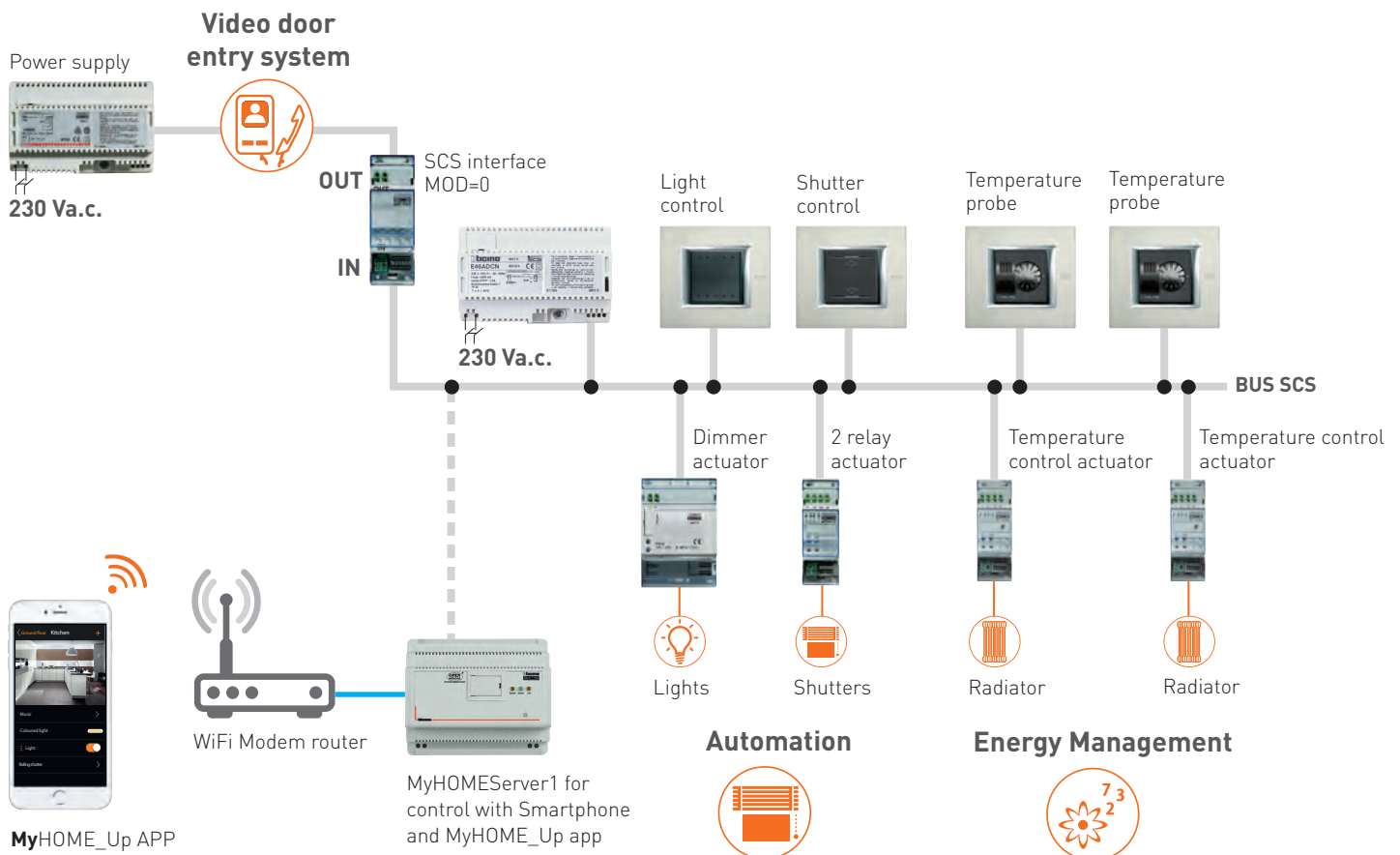

A2. Use of HOMETOUCH Touch Screen

When managing home automation and video door entry system functions using the HOMETOUCH touch screen, interface F422 is not required.

In this case, the integration is completed from HOMETOUCH connected to the Automation and Video door entry system BUS.

The MyHOMEServer1 gateway must also be installed in the system, for the integrated management of the Automation, Temperature control and Video door entry system for the association of the devices.

Function control can be completed locally or remotely using the Smartphone, with the MyHOME_Up and Door Entry Apps.

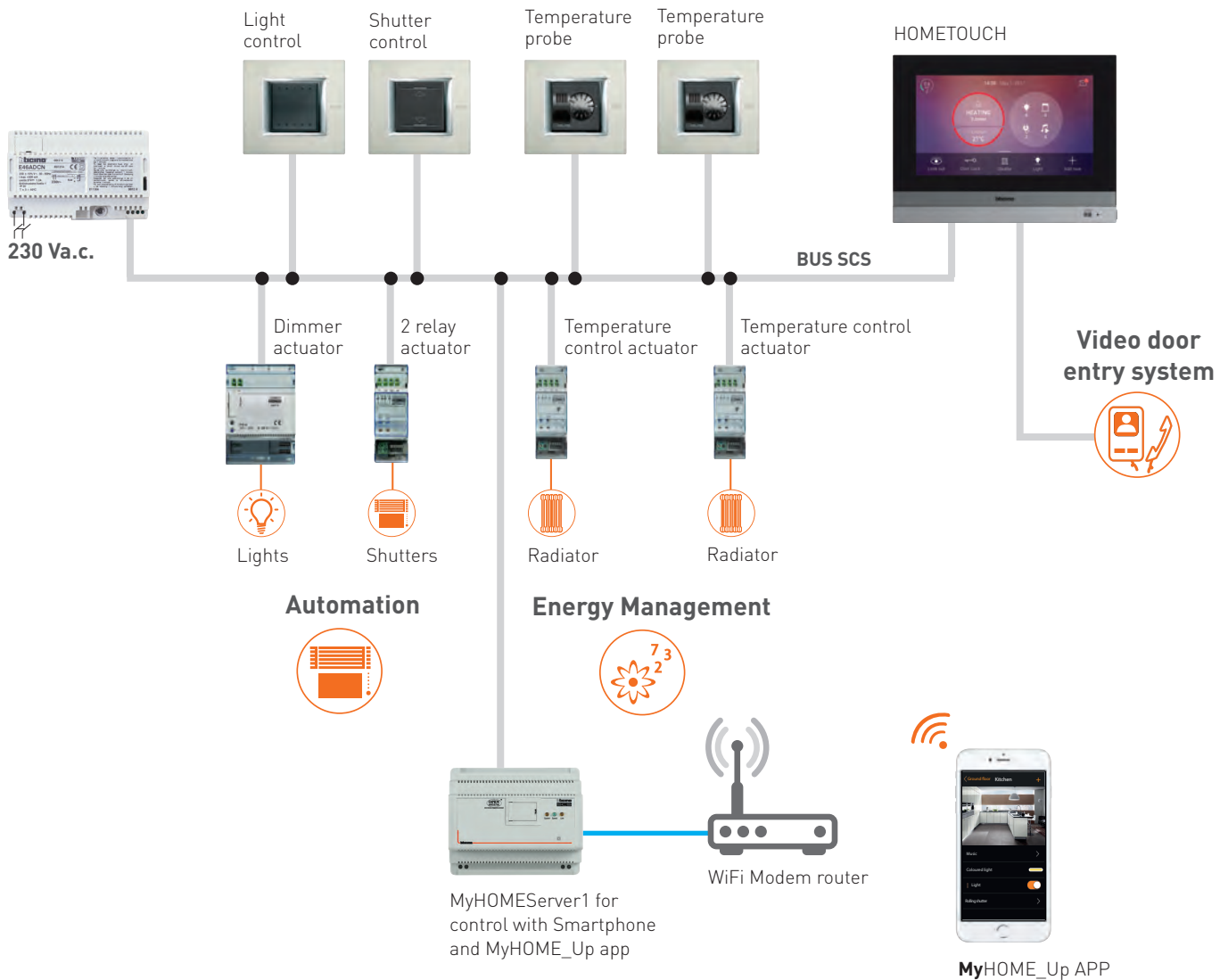

Function integration

INTEGRATION OF MyHOME_Up SYSTEMS WITH BTICINO AND/OR OTHER PARTS SYSTEMS

B. Use of Gateway item MyHOMEServer1

The use of MyHOMEServer1 allows the integration of automation, temperature control and video door entry system with other BTicino systems or third party systems, such as the burglar alarm, coloured lights and sound diffusion.

As shown in the diagram below, the integration of these systems takes place through the LAN network and with the TCP/IP communication protocol. The Burglar alarm system is already preset for the connection to the LAN network, while for the connection of the Automation and/or Temperature control systems it is necessary to use the MyHOMEServer1 gateway.

In addition to the control of all the functions using the Smartphone and the MyHOME_Up App, and the HOMETOUCH touch screen, it will be possible to create Smart scenarios resulting from the synergy

of several systems; for example, when activating the Burglar alarm system when leaving the house, it is possible to set the temperature at an economy level, closing the shutters and switching the lights off.

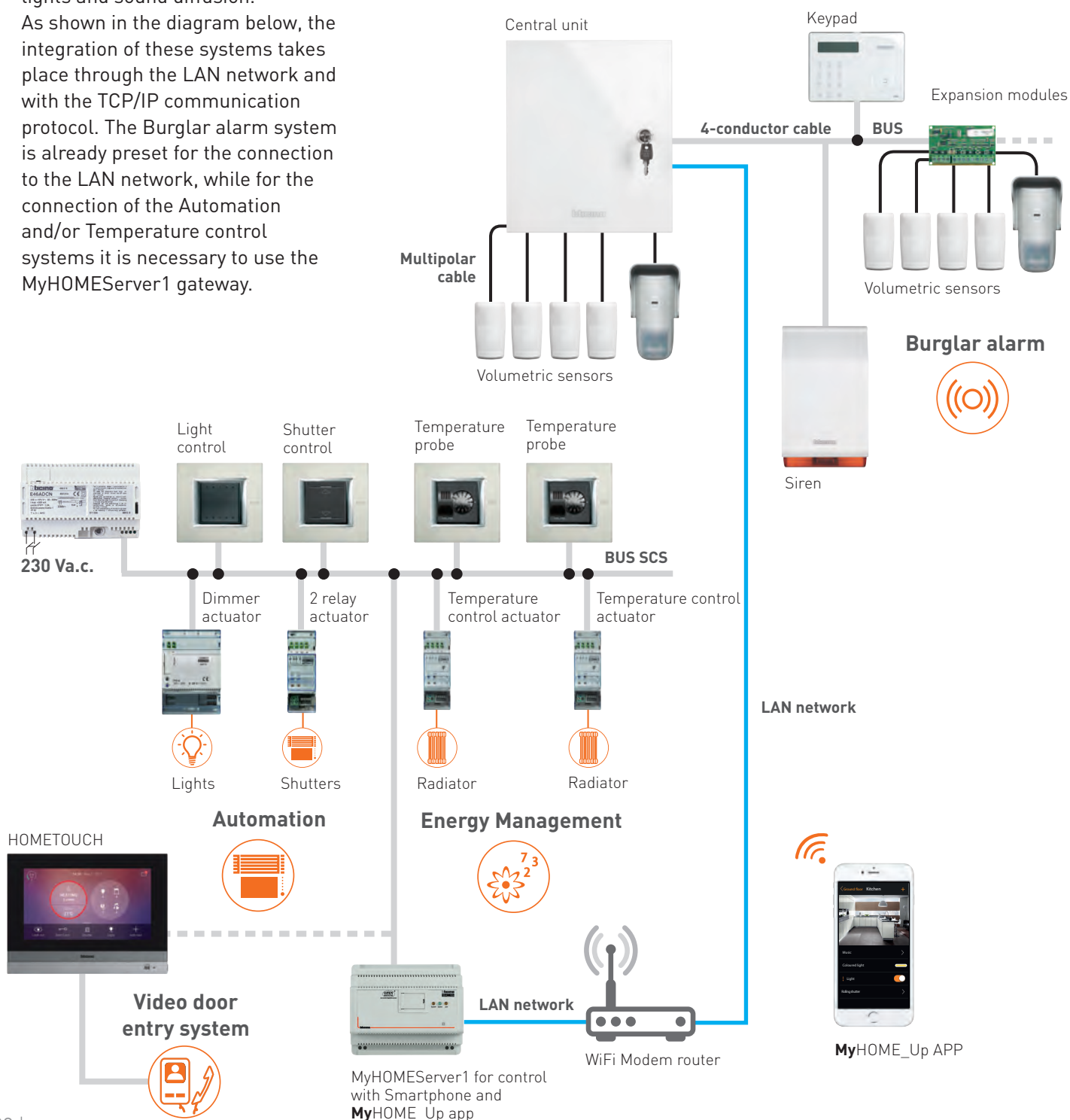

This page shows another example of integration through the LAN network of Automation, Temperature control, NUVO multiroom audio system, and lighting with Philips HUE lamps.

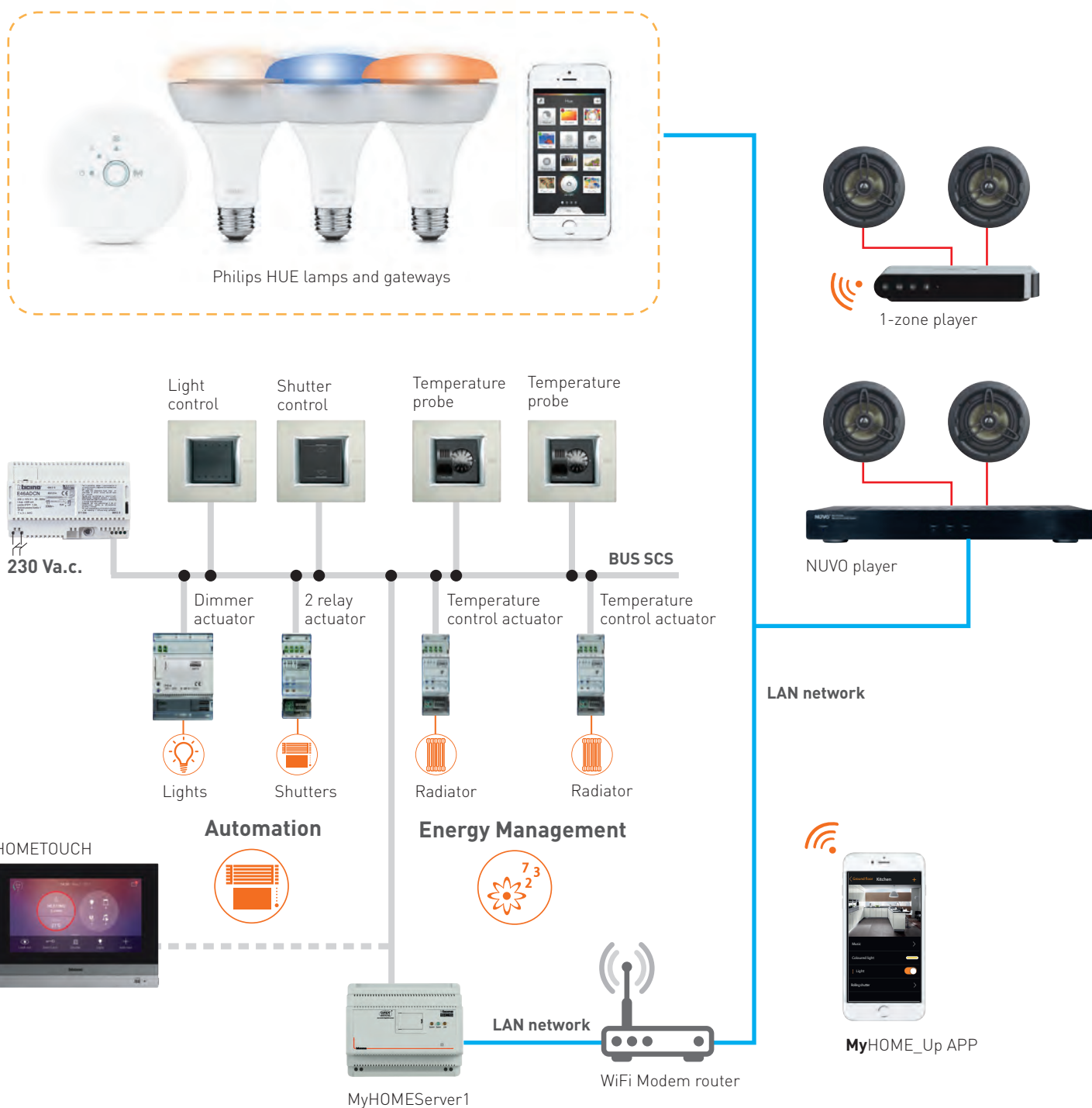

Function integration

INTEGRATION OF MyHOME_Up SYSTEMS WITH BTICINO AND/OR OTHER PARTS SYSTEMS

C. Integration by means of Driver manager gateway item F459

This integration solution uses the Driver manager, item F459, appropriately configured with the specific driver, specifically made to manage functions/systems of third-party manufacturers. It is for example possible to manage, through the MyHOME zone

temperature control system, VRV, VRF and air conditioning systems of the main manufacturers on the market. The F459 device can be programmed with several drivers, for the management of several systems integrated with MyHOME.

For technical information, details and a view of all the available drivers, visit: www.bticino.com

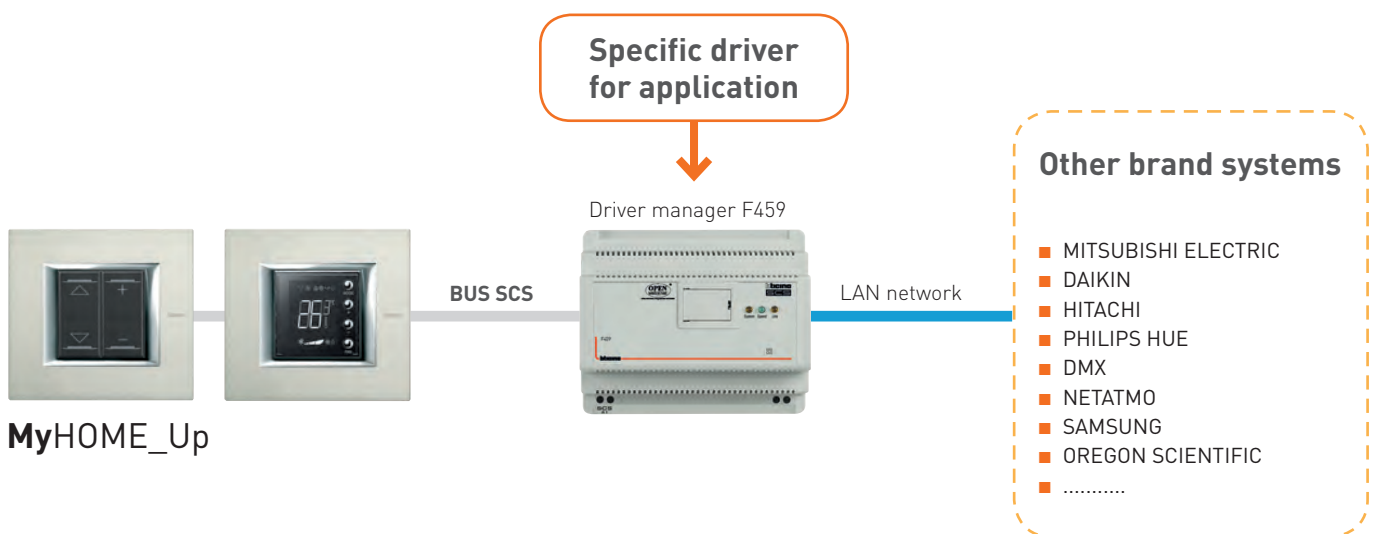

D. Integration by means of dedicated interfaces

The MyHOME_Up catalogue also includes the F429 interface for the integration of the DALI protocol.

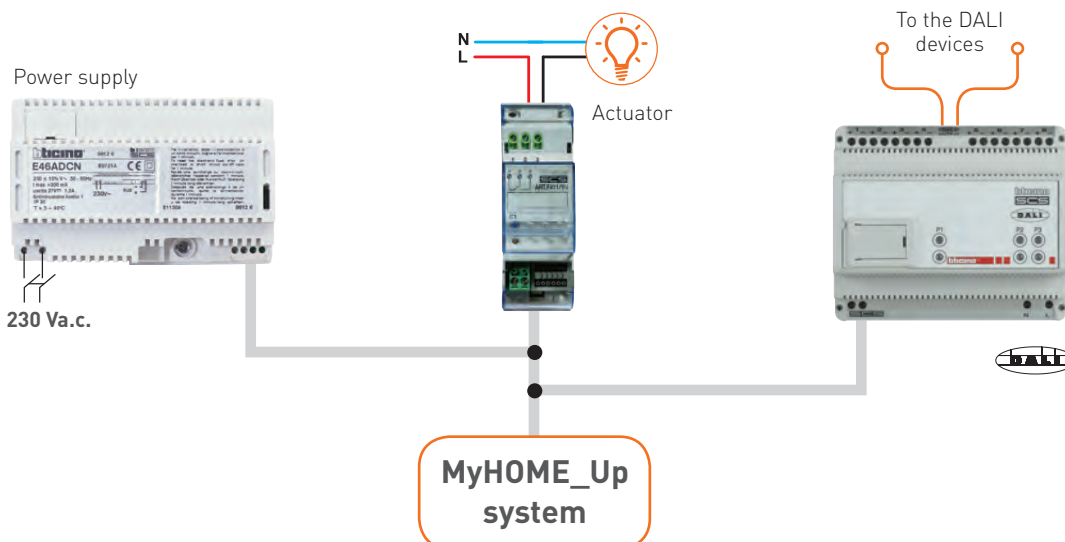

E. Integration using the Application Programming Interface (API)

API integration can be made in two ways:

- interoperability through the sharing of different languages on the IP level (local and through the cloud).
- interoperability through IOT Cloud platforms, for example Artik Samsung and similar.

Works With Legrand is available for professionals that must use this integration solution.

This is the open interoperability platform, a strategic part of the Eliot program (program of the connected objects of the Legrand group). Compatible with the main IoT world players, it gives the possibility of connecting with the Legrand ecosystem in several ways, allowing small and large developers to interact with **MyHOME_Up**.

For more details please visit: www.bticino.com





MyHOME_Up – Software and Services

GENERAL FEATURES

Home configurator Web App

The HOME configurator is a tool that helps the installer or the final user to correctly estimate an electric system, either traditional, traditional with connected Smart devices, or **MyHOME_Up** BUS.

The application, available after free registration on the <https://my.bticino.it> website, offers a range of “standard homes” that can be modified based on specific needs. For each home the functions to value can also be defined.

- Driving force and services;
- Light;
- Shutters;
- Temperature control;
- Consumption display;
- Electric panel;
- Protections.

After selecting the function, the application requires the definition of the system technology:

- traditional;
- traditional with connected Smart devices;

- **MyHOME_Up** BUS, and to customise the control/device points in the various finishes: Axolute, Mâtix, Livinglight and Living Now. With this simple information, the application will provide the value for the total system, or split into rooms,

which can be changed at any time, and saved in the MyBTicino personal area. If the system is a **MyHOME_Up** system, also the total system current consumption will be supplied, for the appropriate checks at the design stage.

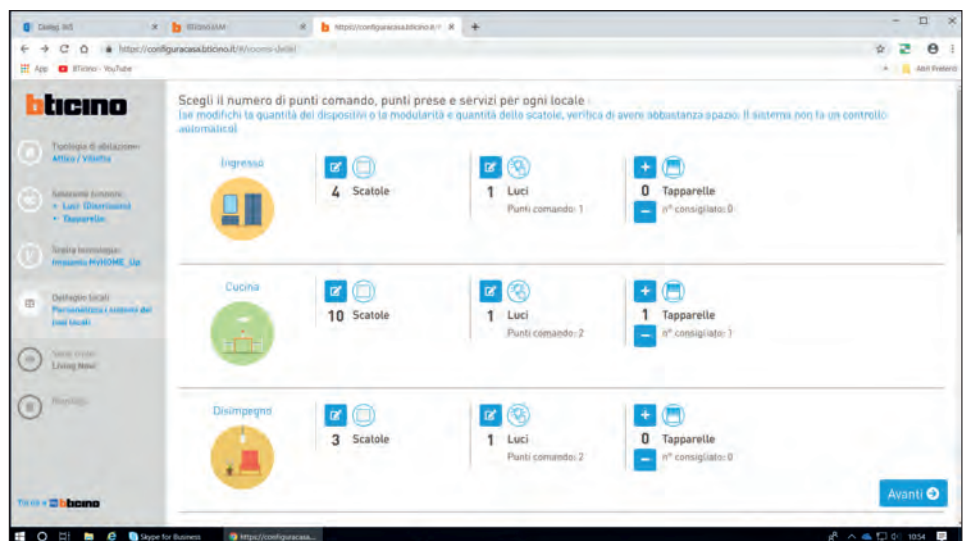

Definition of the functions to value.

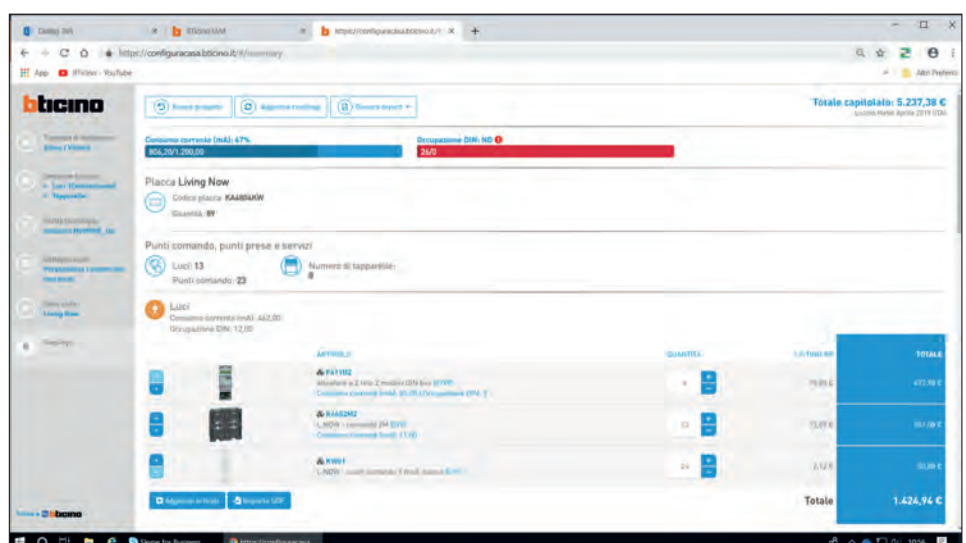

Example of system estimation.

NOTE: to ensure constant product improvement, this software may be subjected to revision. We therefore recommend that the my.bticino.it website is checked regularly to make sure to obtain the most recent version of the web application.

GENERAL FEATURES

YouDiagram software

YouDiagram is the software for the design and configuration of 2 wires video door entry systems and wired-radio burglar alarm systems.

It allows to draw the system diagram, select the finish of the devices and their configuration. It also quickly provides the total value of the current absorption of the system, for the appropriate design checks.

Example of YouDiagram software screenshot

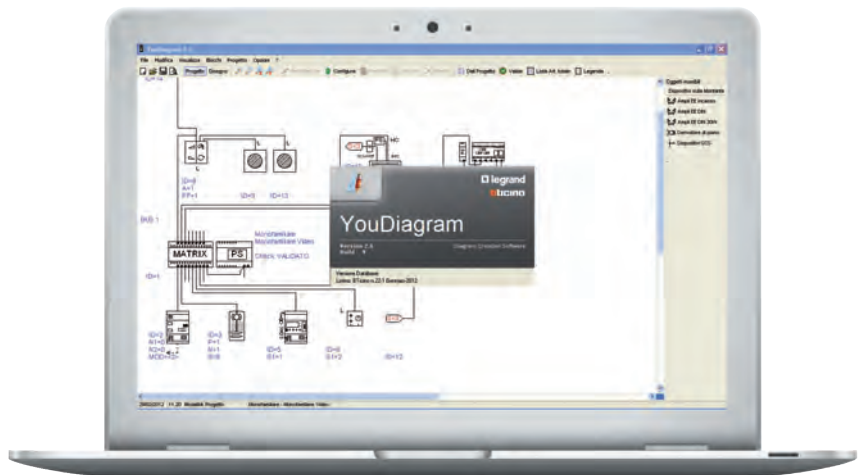

The software can be downloaded free of charge from the website

<https://professionisti.bticino.it/software-e-app/software-di-progettazione/>

Example of a video door entry system design

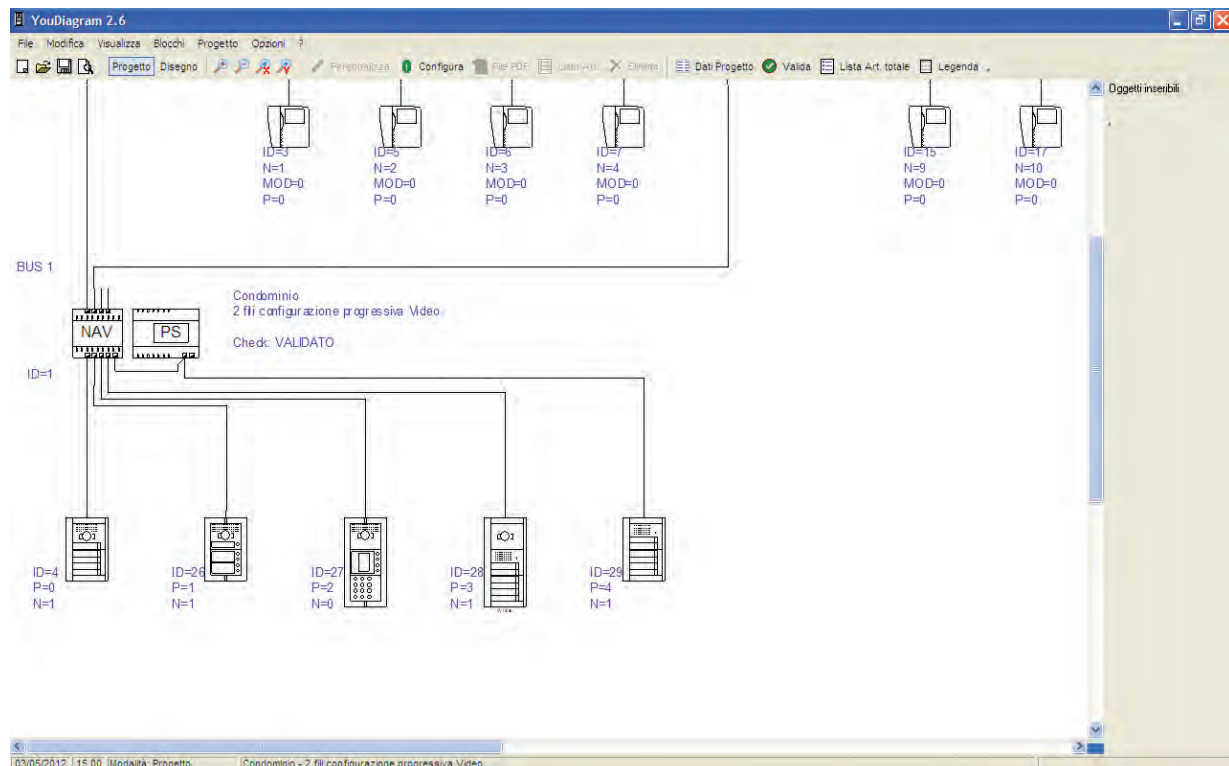

NOTE: to ensure constant product improvement, this software may be subjected to revision. We therefore recommend that the my.bticino.it website is checked regularly to make sure to obtain the most recent version of the web application.

MyHOME_SUITE

MyHOME_Suite is the application that can be used in alternative to the MyHOME_Up App to assign functions to the devices of the Automation, Energy management and Temperature systems.

The connection of the system to the PC can be completed using the MyHOMEServer1 web server.

The software can be easily downloaded free of charge from the website www.homesystems-legrandgroup.com

On-line update icon

Icon for the consultation of the software integrated user guide

Web Server IP address and connection status display

List of configurable items

Working area for the collection of the system devices to configure

Selection of the parameters for the configuration of the address and the operating mode

GENERAL FEATURES

Service and digital tools

CUSTOMER SERVICE



TECHNICAL-COMMERCIAL INFORMATION

Toll-free number for the request of technical documentation and technical and commercial documentation, available
From Monday to Friday 8:30 to 18:30

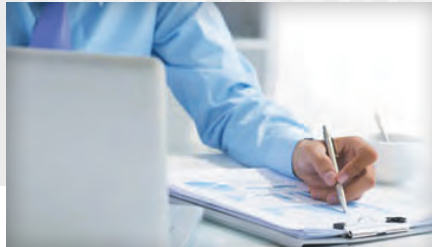

ESTIMATION SERVICE

To request detailed estimates regarding MyHOME_Up applications, including integrated applications.
For more information see the "Services" section in the following site:
www.professionisti.bticino.it.



TECHNICAL SUPPORT SERVICE

Authorized Technical Support Centres to request assistance for products and systems with or without warranty.

WEBSITES FOR PROFESSIONALS

A wide range of content to get to know the BTicino range better.

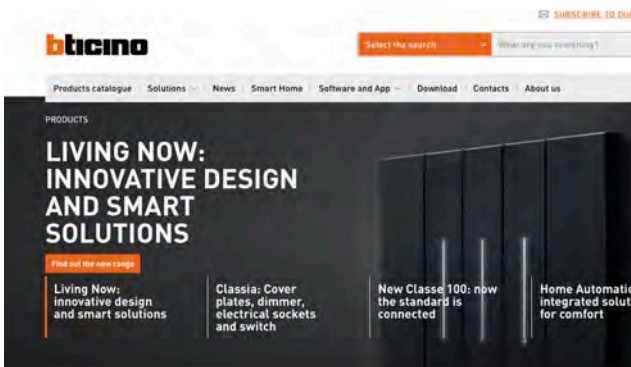

MYOPEN COMMUNITY

The home automation system integrator community, with detailed information and services relating to new applications.

www.myopen-legrandgroup.com



BTICINO.COM

Visiting www.bticino.com, it will be possible to acquire all the product information and the technical content that will help you to improve your knowledge of the BTicino offer.



ON LINE CATALOGUE

The quickest way to find technical information and the prices of our products.

<https://catalogue.bticino.com/prbt/bticino/wiring-devices/living-now/living-now-my-home-up>



CONTENTS

MyHOME_Up catalogue	108
MyHOME FLATWALL catalogue	126
Appendix	138

INTEGRATION AND CONTROL





MyHOMEserver1



3488







F429

Item	CONTROL SERVER USING THE APP
<input type="radio"/> MyHOMEserver1 	server to associate devices during the system starting-up and for the local and remote management of the functions by the user with the specific MyHOME_Up application for Android and iOS smartphones or tablets.
<input type="radio"/> MHSERVERKIT 	MyHOMEserver1 KIT kit containing MyHOMEserver1 and Access Point for communication between the MyHOME_Up system to which it is connected, and a smartphone or tablet where the MyHome-Up App is installed.

Note: For the details of the products managed by MyHome_Up and the compatible products, see the corresponding guide.

	HOMETOUCH - TOUCH SCREEN 7"
<input type="checkbox"/> 3488W <input checked="" type="checkbox"/> 3488 	HOMETOUCH - Touch Screen 7" for the management of all MyHOME_Up functions, that can be integrated with the video door entry system, to be used as connected internal unit. To use the home automation functions, configuration is not necessary. It is possible to display the MyHOME_Up system status and control the integrated functions (lights, automation, scenarios, burglar alarm, temperature management, Nuvo music system, ...). Thanks to the "DOOR ENTRY for HOMETOUCH" application, available both for Android and iOS operating systems, it is also possible to manage the video door entry functions of a BTicino 2 wires system using the 7" capacitive display or the Smartphone. Flush mounted installation with box for masonry walls (item 3487) or wall mounted installation with the supplied metal bracket. Available in tech grey and in white.

	BOX FOR FLUSH MOUNTED INSTALLATION
<input type="radio"/> 3487 	box for flush mounted installation of the HOMETOUCH Touch screen item 3488 and 3488W. Width 197 mm, height 148 mm and depth 52 mm.
<input type="radio"/> 3487AP 	support for flush mounted installation on plasterboard walls of the HOMETOUCH Touch screen item 3488 and 3488W.

Item	SCS/DALI INTERFACE
<input type="radio"/> F429 	DALI dimmer, 8 independent outputs with maximum load 16 ballast at 230 Vac, pushbutton for load direct control - 6 DIN modules
<input type="radio"/> F459 	DRIVER MANAGER integration platform with other brand systems - 6 DIN modules

Contact the BTicino System Integration Service to check the feasibility of specific integrations and to request the licence needed to use the Driver manager (Toll free number 800.837035)

LIVING NOW DIGITAL DEVICES FOR LIGHTS AND SHUTTERS



KG8013



K8003



KM8010



KW8011



KG8100



KW8103



K8002L



K8002S



K8001

Item

VOICE CONTROL

- KW8013
- KG8013
- KM8013



Amazon Alexa digital control device with voice assistant, including two capacitive controls for lighting management.
27 Vd.c. power supply from BUS through connection module item KW8001 or additional power supply unit, item K8003 - 3 modules

Item

BLANKING MODULE.

- KW8100
- KG8100
- KM8100



covers for blanking modules item K4950 - 1 module

POWER SUPPLY

- K8003



voice command additional power supply unit, item KW/KG/KM8013 - 2 modules

LIGHT CONTROL

- KW8010
- KG8010
- KM8010



capacitive control for the management of one or two controlled socket and light ON/OFF type functions. It can also be used to manage 4 protected scenarios - 1 module

FULL CONTROL

- KW8011
- KG8011
- KM8011



capacitive control for the management of one to three functions among the following: on/off, dimmer, coloured lights, up/down without preset, scenarios, Nuvo multi-room sound system and load control. It can also be used as group or general control. On-board proximity sensor that allows the display of function icons when approaching the control - 1 module

ON/OFF ACTUATORS FOR LIGHTS AND FOR SHUTTERS

- K8002L



actuator with 2 independent relays for single or double 230 V a.c. loads: 16 A - 1 module

- K8002S



shutter actuator with 2 internal relays 2 A 250 Va.c. In addition to the monostable and bistable UP/DOWN function, the actuator also places the shutter in a stored (PRESET) position - 1 module

CONNECTION MODULES

- K8001



device for the power supply of controls through electrified frame
item KW/KG/KM8103.....8104.....

ELECTRIFIED FRAME

- KW8102P1
- KG8102P1
- KM8102P1



electrified frame with intermediate control separators (removable). For the installation of up to 3 digital controls or covers, item KW/KG/KM8100 in 2-module box with support K8102

- KW8103
- KG8103
- KM8103



electrified frame with intermediate control separators (removable). For the installation of up to 3 digital controls or covers, item KW/KG/KM8100 in 3-module box with support K4703

- KW8103P1
- KG8103P1
- KM8103P1



electrified frame with intermediate control separators (removable). For the installation of up to 4 digital controls or covers, item KW/KG/KM8100 in 3-module box with support K4703

- KW8104
- KG8104
- KM8104



electrified frame with intermediate control separators (removable). For the installation of up to 4 digital controls or covers, item KW/KG/KM8100 in 4-module box with support K4704

- KW8104P1
- KG8104P1
- KM8104P1



electrified frame with intermediate control separators (removable). For the installation of up to 5 digital controls or covers, item KW/KG/KM8100 in 4-module box with support K4704

2-MODULE SUPPORT FOR ELECTRIFIED FRAME ITEM8102P1

- K8102



support for the installation of the electrified frame item8102P1 in 2 module box

LIGHTS AND SHUTTER AUTOMATION



H4651M2



L4652/2



AM5832/3



K4652M2



H4652



HS4680

Item **CONTROLS FOR SINGLE OR DOUBLE LOADS**
control which can drive a single actuator for single or double loads or two actuators for single loads or independent double loads – to be completed with 1 2-module key cover for controls with one or two functions or 2 1-module key covers with one or two functions - 2 modules

- H4652/2
- L4652/2
- AM5832/2



Axolute
Livinglight
Màtix

control which can drive three actuators for single or double loads or two actuators for single loads or independent double loads – to be completed with 3 1-module key covers for controls with one or two functions - 3 modules

- H4652/3
- L4652/3
- AM5832/3



Axolute
Livinglight
Màtix

CONTROL FOR SHUTTER MANAGEMENT

2 module flush mounted control with reduced thickness with 3 pushbuttons. In addition to monostable and bistable UP/DOWN operation, the device also places the shutter in a stored (PRESET) position.

- H4660M2
- LN4660M2
- AM5860M2



Axolute
only suitable for operation with advanced actuators H4661M2 and F401, specific for the management of shutters.

Livinglight
only suitable for operation with advanced actuators LN4661M2 and F401, specific for the management of shutters.

Màtix
only suitable for operation with advanced actuators LNAM5860M2 and F401, specific for the management of shutters.

CONTROL FOR SPECIAL FUNCTIONS

special control – can drive an actuator performing all the standard functions of a control and in addition some special functions: activation of 4 scenarios, timings, activation of an actuator installed on a different bus than the control, selection of the fixed adjustment level and the dimmer soft-start and soft-stop speed, sound system, door lock switching on control, call to the floor and switching on staircase light control and management of auxiliary channels. To be completed with 1 or 2-module key covers with one or two functions - 2 modules

- H4651M2
- L4651M2
- AM5831M2



Axolute
Livinglight
Màtix

Item **CONTROL FOR SPECIAL FUNCTIONS**
control for the management of one or two ON/OFF functions, the shutter UP/DOWN function and the adjustment of a dimmer load. It can also be used as scenario control and for the call to the floor, staircase light switching on and door lock activation functions. It manages advanced shutter functions. - 2 modules.
To be completed with 1 or 2-module covers.

- K4652M2



Living Now

Control for the management of up to three separate functions as described above - 3 modules. To be completed with 1 or 2-module covers.

- K4652M3



Living Now

SCENARIO CONTROL

customisable scenario control for the activation of up to 4 Automation, Temperature Control and Sound System independent scenarios saved in the F420 scenario module - 2 modules.

- H4680
- HC4680
- HS680
- N4680
- NT4680
- L4680



Axolute

Livinglight

8-KEY control for light management, shutter automation, sound system and scenarios - SCS-BUS connection - sizes: 2 modules

- H4652
- LN4652



Axolute

Livinglight

A5 sheets for the customisation of the control symbols item H4652 and LN4652.

The sheets can be customised using the tool found in the MyHOME_Suite configuration software.

- 3541
- 3542

black

white

HOME-AUTOMATION HINGE

- 4911TDM



Livinglight

accessory for the installation of 2-module key covers on devices installed in 503E box

LIGHTS AND SHUTTER AUTOMATION



HD4657M3



HS4657M3



MHKIT1116

Item **GLASS CONTROLS**

Axolute
MyHOME control which can control single loads or group loads (e.g. lights and shutters), sound system, scenario, basic door entry functions (e.g. gate opening). It has capacitive keys, which are touch activated. They can be identified by LED with light of adjustable intensity.

WHITE GLASS

HD4657M3 6-key control – size: 3 modules

HD4657M4 8-key control – size: 4 modules

WHICE

HC4657M3 6-key control – size: 3 modules

HC4657M4 8-key control – size: 4 modules

NIGHTER

HS4657M3 6-key control – size: 3 modules

HS4657M4 8-key control – size: 4 modules

NOTE: for white glass controls check contact your local BTicino commercial representative for availability

Item **CONTACT INTERFACE**

3477  basic module control interface with 2 independent contacts for the control of 2 actuators for single function loads, or 1 actuator for double function loads (shutters) – the inputs accepts two traditional switches or pushbuttons with NO and NC contact, or a traditional two-way switch, or interlocked pushbuttons

F428  as above - 2 DIN modules

MEMORY MODULE

F425  module for saving the status of the actuators - to reset the light Automation system in case of blackout - 2 lowered DIN modules

KIT - SHUTTER AUTOMATION

MHKIT1013 solution for the automation of shutters. It gives the possibility of controlling 5 motorised shutters or curtains, or mixed shutter/curtain solutions, with individual and general controls. The kit includes:

- 1 power supply item E49
- 1 shutter control item LN4660M2
- 5 shutter actuators item LN4661M2
- key covers with UP/DOWN and STOP symbols
- various configurators.

It can be expanded with other similar actuators or integrated with other MyHOME functions. LIVINGLIGHT aesthetic (White, Tech, Anthracite finishes)

KIT - LIGHT AND SHUTTER AUTOMATION

MHKIT1116 solution for the control of 6 shutters or 6 lights and 3 shutters, or 12 light points, with general and individual controls. It is possible to save the shutter position. The kit includes:

- 1 power supply item E49
- 1 shutter control item L4652/2
- 6 shutter actuators item LN4672M2
- various configurators. To be completed with LIVINGLIGHT key covers. It can be expanded with other MyHOME devices that share the BUS cable, item L4669.

Note: the following products are not included in the package and have to be purchased separately:

- cable (sheathed pair) art. L4669 sold in 100 m coil;
- flush and wall mounted boxes, supports and front cover plates of the LIVINGLIGHT range.

INSTALLATION OF THE GLASS DIGITAL CONTROL

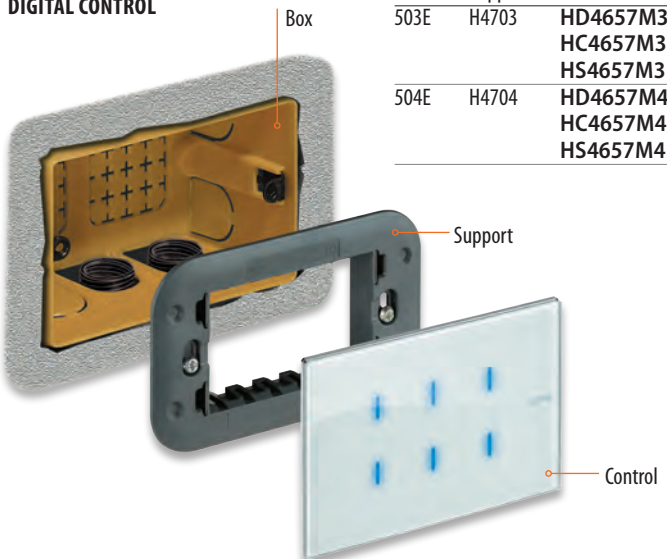

Box	Support	Control
503E	H4703	HD4657M3 HC4657M3 HS4657M3
504E	H4704	HD4657M4 HC4657M4 HS4657M4

LIGHTS AND SHUTTER AUTOMATION



H4672M2
LN4672M2
AM5852M2

Item

LIGHT AND SHUTTER CONTROL/ACTUATOR

actuator/control with 2 independent relays - for single, double or mixed loads: 1380 W resistive, 1380 W incandescence lamps, 460 W for reducer motors, 460 VA $\cos\phi$ 0.5 for ferromagnetic transformers and 250 W for fluorescent lamps - logic relay interlock via configuration. The device can be also configured to manage a remote actuator equipped with "zero crossing" technology. - 2 modules.

- H4672M2
- LN4672M2
- AM5852M2



Axolute
Livinglight
Matic

LIGHT CONTROL/ACTUATOR

- 3476

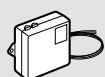

1 relay actuator - for single loads: 2 A resistive or incandescence lamps, 2 A $\cos\phi$ 0.5 for ferromagnetic transformers - a traditional pushbutton with NO contact accepted in input



K4672M2S

Item

LIGHT CONTROL/ACTUATOR

actuator/control with 2 independent relays - for single, double or mixed loads: 1380 W resistive, 1380 W incandescence lamps, 460 W for reducer motors, 460 VA $\cos\phi$ 0.5 for ferromagnetic transformers and 250 W for fluorescent lamps. The device can be also configured to manage a remote actuator equipped with "zero crossing" technology. - 2 modules.

- K4672M2L



Living Now

SHUTTER CONTROL/ACTUATOR

2 module flush mounted actuator with 2 internal relays and 4 pushbuttons. In addition to monostable and bistable UP/DOWN operation, the actuator also places the shutter in a stored (PRESET) position.

- H4661M2
- LN4661M2
- AM5861M2
- K4672M2S



Axolute
to be combined with control devices H4660M2
Livinglight
to be combined with control devices LN4660M2
Matic
to be combined with control devices AM5860M2



Living Now
equipped with "zero crossing" technology

Warning: unless specifically indicated in the Instruction Sheet, insert a 10 A magnetothermic protection on the line that carries power to the actuators.

LOADS THAT CAN BE DRIVEN (230 Va.c. 50/60 Hz)

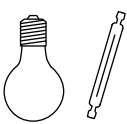
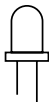
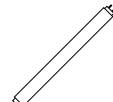
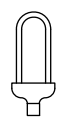
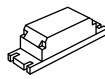
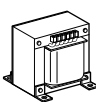
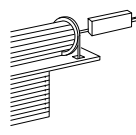
Actuators	Type						
							
	Energy saving incandescence and halogen lamps	LED lamps	Linear fluorescent lamps ¹⁾	Compact fluorescent lamps	Electronic transformers ³⁾	Ferromagnetic transformers ^{2) 3)}	Reducer motors for shutters ⁴⁾
H4672M2 LN4672M2 AM5852M2 K4672M2L	1380 W	250 W Max 10 lamps ⁵⁾	250 VA	250 W Max 10 lamps ⁵⁾	460 W	460 VA	460 W
3476	2 A 460 W	40 W Max 1 lamp	- -	40 W Max 1 lamp	- -	2 A $\cos\phi$ 0,5 460 VA	- -
H/L4661M2 AM5861M2 K4672M2S	-	-	-	-	-	-	2 A 250 Va.c.

Notes:

- 1) Power factor corrected fluorescent lamps, discharge lamps.
- 2) Account must be taken of the transformer yield to calculate the effective power of the load connected to the actuator. For example if a dimmer is connected to a 100 VA ferromagnetic transformer with yield 0.8, the effective power of the load will be 125 VA.
- 3) The transformer must be loaded at its rated power and however never less than 90% of this power. It is preferable to use a single transformer rather than several transformers in parallel. For example it is better to use a single 250 VA transformer with 5 50W spotlights connected rather than use 5 50 VA transformers in parallel each with a 50 W spotlight.
- 4) The  symbol on the actuators refers to the shutter reducer motors.
- 5) The declared number of lamps is to be understood as using the "Zero crossing" function. For more information, refer to the specific product documentation.

LIGHTS AND SHUTTER AUTOMATION



F411U2



F411/4





BMSW1003



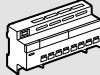

F401

Item	ACTUATORS FOR CENTRALISATIONS	
○ F411U2		actuator with 2 independent relays – for single and double loads: 10 A resistive and 6 A incandescence lamps, 500 W for reducer motors, 2 A $\cos\varphi$ 0,5 for ferromagnetic transformers and 250 W for fluorescent lamps - logic relay interlock via configuration - it has "Zero crossing" technology - 2 DIN modules
○ F411/4		actuator with 4 independent relays - for single, double or mixed loads: 2 A resistive, 2 A incandescence lamps, 500 W for reducer motors, 2 A $\cos\varphi$ 0,5 for ferromagnetic transformers and 70 W for fluorescent lamps - logic relay interlock via configuration - 2 DIN modules

Item	ACTUATORS FOR CENTRALISATIONS	
○ BMSW1003		ON/OFF actuator, 4 independent outputs with maximum load 16 A at 230 Va.c., clamp connection and RJ45, IP20 protection index, power supply 100/240 Va.c. 50/60 Hz, pushbuttons for load direct control - zero-crossing function - 6 DIN modules
○ BMSW1005		ON/OFF actuator, "Zero Crossing" technology, 8 independent outputs with maximum load 16 A at 230 V a.c., clamp connection, IP20 protection index, power supply 100/240 V a.c. 50/60 Hz, pushbuttons for load direct control - 10 DIN modules
○ F401		actuator with 2 internal relays and 4 pushbuttons. In addition to monostable and bistable UP/DOWN operation, the actuator also places the shutter in a stored (PRESET) position - 2 DIN modules

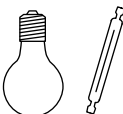
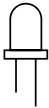
Warning: unless specifically indicated in the Instruction Sheet, insert a 10 A magnetothermic protection on the line that carries power to the actuators.

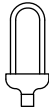
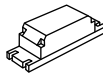
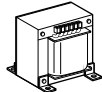
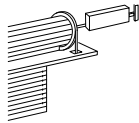
LOADS THAT CAN BE DRIVEN (250 Va.c. 50/60 Hz)							
Actuators	Type						
							
	Energy saving incandescence and halogen lamps	LED lamps	Linear fluorescent lamps ¹⁾	Compact fluorescent lamps	Electronic transformers ³⁾	Ferromagnetic transformers ^{2) 3)}	Reducer motors for shutters ⁴⁾
F411U2	10 A 2300 W	500 W Max 10 lamps ⁵⁾	4 A 920 W	500 W Max 10 lamps ⁵⁾	4 A 920 W	4 A $\cos\varphi$ 0,5 920 VA	2 A 460 W
F411/4	2 A 460 W	70 W Max 2 lamps	0.3 A 70 W	70 W Max 2 lamps	0.3 A 70 W	2 A $\cos\varphi$ 0,5 460 VA	2 A 460 W
BMSW1003	16 A 3680 W	2.1 A 500 VA	10 X (2 X 36 W) 4.3 A	1150 W 5 A	16 A 3680 W	16 A 3680 W	- -
BMSW1005	16 A 3680 W	2.1 A 500 VA	4.3 A 10X2X36 W	5 A 1150 VA	16 A 3680 W	16 A 3680 W	- -
F401							2 A 250 Va.c.

Notes:

- 1) Power factor corrected fluorescent lamps, discharge lamps.
- 2) Account must be taken of the transformer yield to calculate the effective power of the load connected to the actuator. For example if a dimmer is connected to a 100 VA ferromagnetic transformer with yield 0.8, the effective power of the load will be 125 VA.
- 3) The transformer must be loaded at its rated power and however never less than 90% of this power. It is preferable to use a single transformer rather than several transformers in parallel. For example it is better to use a single 250 VA transformer with 5 50W spotlights connected rather than use 5 50 VA transformers in parallel each with a 50 W spotlight.
- 4) The  symbol on the actuators refers to the shutter reducer motors.
- 5) The declared number of lamps is to be understood as using the "Zero crossing" function. For more information, refer to the specific product documentation.

LIGHTS AND SHUTTER AUTOMATION



F413N

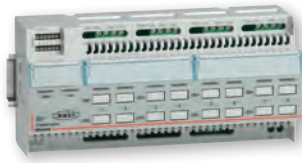

BMDI1002

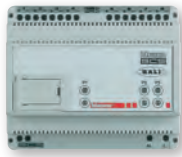



F429





F416U1

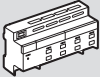





F418U2

Item	DIMMERS FOR CENTRALISATIONS	
○ F413N		1-output dimmer to supply fluorescent lamps or LED sources with input 1-10 V for single loads up to 2.5 A at 230 Va.c. – type of screw connection - power supply 27 Vd.c. – absorption 30 mA – max 10 ballast that can be connected (clamps 1-2) - with pushbutton for load direct control - version for fastening on DIN rail - 2 modules
○ BMDI1002		1/10V dimmer, “Zero Crossing” technology, 4 outputs with maximum load 4.3 A at 230 V a.c., clamp connection, IP20 protection index, power supply 100/240 V a.c. 50/60 Hz, pushbuttons for load direct control - 10 DIN modules
○ F429		DALI dimmer with 8 independent outputs for the connection of up to 16 DALI reactors for each output – 230 V a.c. power supply 50/60 Hz; 110 - 240 Vd.c. – absorption 5 mA - with pushbutton for load direct control - version for fastening on DIN rail - 6 modules

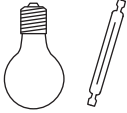
Item	MULTI-LOAD DIMMERS FOR CENTRALISATIONS	
○ F416U1		multi-load dimmer, 1 output with maximum load 4.3 A at 230 Va.c., clamp connection and RJ45, IP20 protection index, power supply 100/240 Va.c. 50/60 Hz, pushbutton for load direct control - 6 DIN modules
○ F418U2		two-channel dimmer for the management of dimmer LEDs, dimmer compact fluorescent lamps (CFL), energy saving halogen lamps and electronic transformers at 110-230V. Possibility of parallelisation of the two channels to increase the maximum power which can be managed. power supply 27 Vd.c., absorption 18 mA - version for fastening on DIN rail - 4 modules

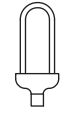
LOADS THAT CAN BE DRIVEN (230 Va.c. 50/60 HZ)

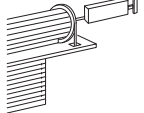
Actuators	Type						
							
BMDI1002	Dimmer for ballast - 4 x 4.3 A outputs - 4x 1000VA@ 230 Vac - 4x500VA@ 230 Vac						
F413N	-	-	2 A 460 W ⁵⁾ Max 10 ballast, type T5, T8, compact or driver for LED	-	-	-	-
F414	0.25 - 4.3 A 60 - 1000 VA	-	-	-	-	0.25 - 4.3 A 60 - 1000 VA	-
F416U1	4.3 A 40 - 1000 W	-	-	-	4.3 A 40 - 1000 W	4.3 A 40 - 1000 W	-
F418U2	2x300 W	2x300 VA	-	2x300 VA	2x300 VA	2x300 VA	-
F429	SCS/DALI dimmer interface - 8 x16 ballast						

Notes:

- 1) Power factor corrected fluorescent lamps, discharge lamps. 2) Account must be taken of the transformer yield to calculate the effective power of the load connected to the actuator. For example if a dimmer is connected to a 100 VA ferromagnetic transformer with yield 0.8, the effective power of the load will be 125 VA.
- 3) The transformer must be loaded at its rated power and however never less than 90% of this power. It is preferable to use a single transformer rather than several transformers in parallel. For example it is better to use a single 250 VA transformer with 5 50W spotlights connected rather than use 5 50 VA transformers in parallel each with a 50 W spotlight.
- 4) The  symbol on the actuators refers to the shutter reducer motors. 5) Only compatible with lamps with 1/10 V ballast.

LIGHT SENSOR



Item **PIR+US DOUBLE TECHNOLOGY GREEN SWITCH**

Green Switch: double technology presence sensor, passive IR and ultrasound (PIR+US), suitable for the detection of presence in working areas (offices, meeting rooms). With manual ON/OFF pushbutton. Operating mode (automatic or manual), time delay (5 s to 59 min), and brightness threshold (20 to 1275 LUX) settable using the advanced/basic (BMSO4001/BMSO4003) configuration remote control; physical or virtual configuration. 2 modules

<input type="checkbox"/> HD4658		Axolute
<input type="checkbox"/> HC4658		
<input type="checkbox"/> HS4658		
<input type="checkbox"/> N4658N		Livinglight
<input type="checkbox"/> NT4658N		
<input type="checkbox"/> L4658N		
<input type="checkbox"/> AM5658		Màtix

Item **PIR PASSIVE INFRARED GREEN SWITCH**

Green Switch: passive IR (PIR) sensor, suitable for the detection of presence in transit areas (corridors, toilets, service rooms). Operating mode (automatic or manual), time delay (5 s to 59min), and brightness threshold (20 to 1275 LUX) settable using the advanced/basic (BMSO4001/BMSO4003) configuration remote control; physical or virtual configuration. 2 modules

<input type="checkbox"/> HD4659		Axolute
<input type="checkbox"/> HC4659		
<input type="checkbox"/> HS4659		
<input type="checkbox"/> N4659N		Livinglight
<input type="checkbox"/> NT4659N		
<input type="checkbox"/> L4659N		
<input type="checkbox"/> AM5659		Màtix
<input type="checkbox"/> K4659		Living Now

DIAGRAM FOR THE USE OF THE GREEN SWITCH, ITEM L/N/NT4658N

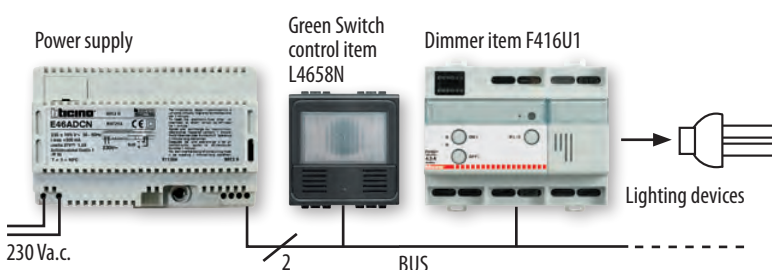

ECO MODE

Manual load activation and automatic switch off managed by the dimmer/actuator based on the detection of the presence of people and the desired level of illumination detected by the control, item L4658N. The function of the control is first of all to activate the automatism of the dimmer/actuator: upon first pressure, the sensor compares the desired light level with the actual light level of the room, and ascertains if the light should be switched on or not. A subsequent pressure of the control forces the switching ON or OFF of the automatism determined by the dimmer/actuator.

LIGHT SENSOR



BMSE3001



BMSE3003



0 488 34



BMSO4001



BMSO4003

Item

LIGHTING/MOVEMENT SENSORS

○ BMSE3001		passive infrared SCS sensor for the detection of movement and the lighting level. Ceiling flush mounted installation using springs or installation boxes; surface installation using surface installation box, item 048875; IP20 protection index; RJ45 clamp connection; 8 m (50 m ²) diameter coverage area for a 2.5 m installation height, maximum installation height 6 m; 27 V d.c. power supply from bus, absorption 12 mA; regulation with basic/advanced remote control (BMSO4003 and BMSO4001) or through configuration software, of the lighting level, from 5 to 1275 LUX, of the time delay, from 30 s to 255 h, and of the main operating parameters; Push&Learn pushbutton
○ BMSE3003		double technology SCS sensor: passive infrared for the detection of presence and the lighting level. Ceiling flush mounted installation using springs or installation boxes; surface installation using surface installation box, item 048875; IP20 protection index; RJ45 clamp connection; 8 m diameter (50 m ²) infrared coverage area for a 2.5 m installation height, 11 mm diameter (95 m ²) ultrasound coverage area for a 2.5 m installation height, maximum installation height 6 m; 27 V d.c. power supply from BUS, absorption 17 mA; regulation with basic/advanced remote control (BMSO4003 and BMSO4001), or through configuration software, of the lighting level, from 5 to 1275 LUX, of the delay, from 30 s to 255 h, and of the main operating parameters; Push&Learn pushbutton
○ 048834		IP55 passive IR (PIR) movement sensor, suitable for the detection of movement in outdoor or indoor transit areas (corridors, cellars, garage paths). Coverage area: 140° x 15m at 2.5m high. Operating mode (automatic or manual), time delay (5 s to 59min), and brightness threshold (20 to 1275 LUX) settable using the advanced/basic (BMSO4001/BMSO4003) configuration remote control; physical or virtual configuration. Wall or angular installation by means of accessory item 048971

Item

CONFIGURATION REMOTE CONTROLS

○ BMSO4001	the advanced configuration remote control, with IR transmitter and receiver, adjusts the main operating parameters of: Switch Sensor, Green Switch and SCS compatible sensors. With display for the acquisition of the parameters set on the sensors and to modify them. Batteries charged by USB mini port.
○ BMSO4003	the basic configuration remote control, with IR transmitter, adjusts the main operating parameters of: Switch Sensor, Green Switch and SCS compatible sensors. Modification of parameters only possible for preset values, battery recharge not available

INSTALLATION ACCESSORIES

○ 048875	ceiling mounted box compatible with the sensors: BMSE3001 and BMSE3003, IP20 protection index, dimensions Ø 100 x 50 mm
○ 048971	angle installation accessory, compatible with the 048834 accessory, IP42 protection index, dimensions (hxlxd) 115 x 75 x 40 mm

FEATURES OF THE LIGHTING/MOVEMENT SENSORS

SCS SENSORS	048834	BMSE3001	BMSE3003
INSTALLATION	wall mounted	ceiling flush mounted	
TYPE OF OPERATION	AUTO/ECO/WALKTHROUGH	AUTO/ECO/WALKTHROUGH	
SENSOR TECHNOLOGY	PIR	PIR	PIR+US
POWER SUPPLY	27 V d.c. from Bus	27 V d.c. from Bus	
PROTECTION INDEX	IP55	IP20	
COVERAGE AREA AT 2.5 m	15 m x 6 m	Ø 8 m	Ø 11 m
COVERAGE ANGLES (v/h)	45°/140°	90°/360°	
LIGHTING LEVEL	5 lux - 1275 lux	5 lux - 1275 lux	
SWITCHING OFF DELAY	5 s - 59 min - 59 h	30 s - 255 h - 59 min - 59 sec	
FACTORY ADJUSTMENTS	300 lux - 15 min	300 lux - 15 min	
CONNECTION TYPE	SCS clamp	RJ45 connector	

TEMPERATURE CONTROL



KG4691



H4691



HS4693





N4693



3454

PROBE WITH DISPLAY
flush mounted device with backlit display. It can be used to control the temperature of an individual zone, irrespective of a temperature control central unit being installed as part of the system or not. It has a temperature probe and an input for the connection of a contact line (e.g. window contact). It can be used for the management of different types of systems, and the adjustment of the fan speed when fan coils are used. Possibility of automatic operation (summer/winter) with compatible systems. bus SCS connection – 2 modules.

- H4691 
- LN4691
- KW4691 
- KG4691
- KM4691

Axolute
Livinglight

Living Now

SLAVE PROBE
probe to control the room temperature for heating and cooling systems – temperature measurement range 3–40 °C – 2 modules



- HD4693
- HC4693
- HS4693
- N4693
- NT4693
- L4693

Axolute

Livinglight

PROBE WITHOUT DISPLAY
temperature probe in basic module with wired sensor - to be associated to the temperature sensor item 3457 and Vantage probe item 8051

ACCESSORIES
temperature probe to be associated to the probe item 3454

ACTUATORS
actuator with 2 independent relays – for single and double loads: 6 A resistive, 2A motor driven valves and pumps - configuration based logic relay interlock - 2 DIN modules

actuator with 4 independent relays - for single, double or mixed loads: 4 A resistive, 1 A motor driven valves, pumps and fan coils - configuration based logic relay interlock - 2 DIN modules



actuator with 8 independent relays for the control of on-off valves, motorised valves (open-close and three points), pumps and fan coils with 2 and 4 tubes - 4A resistive, 1A motor valves, pumps and fan-coils- SCS-bus connection - 4 DIN modules



actuator with 3 independent relays and 2 x 0-10 Volts outputs for the control of fan coils with 2 and 4 tubes with proportional 0-10 Volt valves - 4A resistive, 1A fan coil - SCS-BUS connection - 4 DIN modules

actuator with 2 x 0-10 Volt outputs for the control of 0-10 proportional valves - SCS-BUS connection - 2 DIN modules

ENERGY MANAGEMENT



Item		CONSUMPTION DISPLAY
○ F520		meter for the measurement of electricity on a maximum of 3 lines, by connecting 3 toroids to the appropriate inputs. Version for fastening on DIN rail - 1 module. The device is fitted with 1 toroid.
○ 3523		Additional electricity meter toroid, item F520 and for actuator with sensor, item F522 for the measurement of the earth leakage current. Cable length 400 mm.
LOAD CONTROL MANAGEMENT		
○ F521		central unit for the management and control of the actuators of the load control system, to prevent the risk of detachment of the limiter of the electricity supplier. The central unit manages up to 63 loads, a contract power between 1.5 and 18 kW, and tolerance up to +/- 20%. It integrates an electricity meter for the controlled line. Version for fastening on DIN rail - 1 module. The device is fitted with 1 toroid.
○ F522		actuator with integrated current sensor for the measurement of the controlled load consumptions. 1 relay - 10 A for incandescence lamps and 4 A for fluorescent lamps or ferromagnetic transformers, and 500 for compact fluorescent and LED lamps - Bistable relay with zero crossing for the Automation and/or Load control management functions. Version for fastening on DIN rail - 1 module. Earth leakage control by connecting the additional toroid, item 3523.
○ F523		1 relay actuator - for incandescence lamps and 4 A for fluorescent lamps or ferromagnetic transformers, and 500 W for compact fluorescent and LED lamps - bistable relay with zero crossing for the Automation and/or Load control management functions. Version for fastening on DIN rail - 1 module.

Item		LOAD CONTROL MANAGEMENT
		1 relay actuator - 10 A for incandescence lamps and 4 A for fluorescent lamps or ferromagnetic transformers, and 500 W for compact fluorescent and LED lamps for the Automation and/or Load control management functions. Pushbutton for forced load operation - flush mounted version - 2 modules
<input type="checkbox"/> HD4672N <input type="checkbox"/> HC4672N <input checked="" type="checkbox"/> HS4672N <input type="checkbox"/> N4672N <input type="checkbox"/> NT4672N <input checked="" type="checkbox"/> L4672N		Axolute
		Livinglight
ACCESSORIES		
○ 3508BUS		removable clamp for BUS connection - width 3.81 mm
○ 3508U2		removable clamp 2 poles
○ 3508U3		removable clamp 3 poles
LOAD CONTROL KIT		
○ MHKIT4015		This kit gives the possibility of managing the maximum power used and automatically disconnect the less important users in case of overload (based on set priority levels). It can easily be expanded and integrated with other MyHOME functions. The kit includes: <ul style="list-style-type: none"> • 1 power supply item E49 • 1 load control central unit item F521 • 1 x 16A actuator with measurement sensor item F522 • 2 actuators item F523 • 1 energy display item LN4710 • various configurators.

COMMON ACCESSORIES AND DEVICES



E46ADCN



E49



3545



L4669
L4669/500



336904

Item		POWER SUPPLIES
<input type="radio"/> E46ADCN		power supply - input 230 Va.c. output 27 Vd.c. SELV - maximum absorbed current 450mA - installation on DIN profile for flush mounted or wall-mounted switchboards - 8 DIN modules
<input type="radio"/> E49		compact power supply - input 230 Va.c. - output 27 Vd.c. Maximum current delivered 600 mA - 2 DIN modules.
VARIOUS ACCESSORIES		
<input type="radio"/> 3545		spare removable clamp
TECHNICAL SUPPORT VOUCHER		
<input type="radio"/> 3545		set of 5 vouchers for the intervention of a Technical Support technician for MyHOME, Video door entry, Telephone, Luminous notification and CCTV systems

Item		GUARANTEE EXTENSION VOUCHERS
<input type="radio"/> MHBASIC5A		voucher for the guarantee extension for up to 5 years for Light and Automation, Energy management, Sound and NUVO, Video door entry and Remote control systems
<input type="radio"/> MHPLUS5A		voucher for the guarantee extension as above, but also valid for Temperature control and Burglar alarm systems, and MyHome_screen 3.5 touch screen devices
<input type="radio"/> MHFULL5A		voucher for the guarantee extension as above, but also valid for MyHome_screen 10 touch screen devices
CONNECTION CABLES		
<input type="radio"/> L4669		sheathed pair made up of 2 flexible wires with unshielded plaited sheath - insulation 300/500 V - complies with standards CEI 46-5 and CEI 20-20 - coil length 100 metres
<input type="radio"/> L4669/500		as above - in 500 m coils
<input type="radio"/> L4669KM1		as above - reel length 1000 m (1)
<input type="radio"/> 336905		as above - low toxicity cable without halogens - ideal for application in environments where fire hazard safety is critical - coil length 200 metres
<input type="radio"/> 336904		specific cable with 2 twisted conductors. It can be installed in underground piping, in accordance with standards (CEI 20-13 and CEI 20-14). It ensures the best performance in video systems (higher distance between EP and Handset when compared with other cables). 200 m coil

System	Cable	
	L4669 L4669/500 L4669KM1 336905	336904
Automation	●	●(1)
Energy Management/Consumption Display	●	●(1)
Temperature control	●	●(1)
Video door entry system		●

NOTE (1): for systems underground cable sections

LIVING NOW KEY COVERS

COVER FOR ACTUATOR ITEM K4672M2L,
CONTROLS ITEM K4652M2 AND ITEM K4652M3

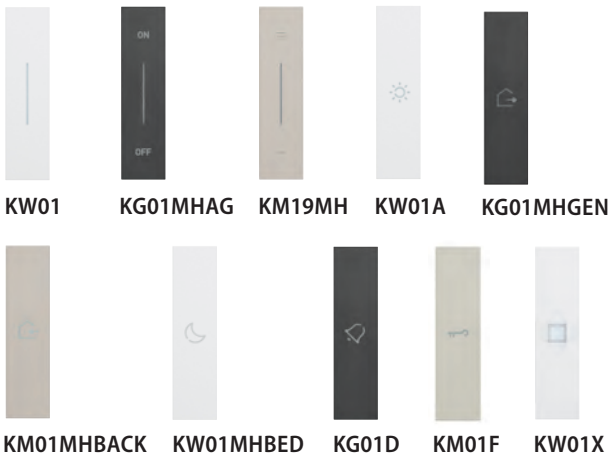

COVER FOR ACTUATOR ITEM K4672M2S,
CONTROLS ITEM K4652M2 AND ITEM K4652M3



LIGHTABLE COVERS - 1 FUNCTION

		1 module
Description		Item
NEUTRAL	<input type="checkbox"/>	KW01
	<input checked="" type="checkbox"/>	KG01
	<input type="checkbox"/>	KM01
ON/OFF	<input type="checkbox"/>	KW01MHAG
	<input checked="" type="checkbox"/>	KG01MHAG
	<input type="checkbox"/>	KM01MHAG
+/- FOR DIMMER	<input type="checkbox"/>	KW19MH
	<input checked="" type="checkbox"/>	KG19MH
	<input type="checkbox"/>	KM19MH
LIGHT/WAKE UP	<input type="checkbox"/>	KW01A
	<input checked="" type="checkbox"/>	KG01A
	<input type="checkbox"/>	KM01A
OUTPUT	<input type="checkbox"/>	KW01MHGEN
	<input checked="" type="checkbox"/>	KG01MHGEN
	<input type="checkbox"/>	KM01MHGEN
COMING IN	<input type="checkbox"/>	KW01MHBACK
	<input checked="" type="checkbox"/>	KG01MHBACK
	<input type="checkbox"/>	KM01MHBACK
BED	<input type="checkbox"/>	KW01MHBED
	<input checked="" type="checkbox"/>	KG01MHBED
	<input type="checkbox"/>	KM01MHBED
DOORBELL	<input type="checkbox"/>	KW01D
	<input checked="" type="checkbox"/>	KG01D
	<input type="checkbox"/>	KM01D
KEY	<input type="checkbox"/>	KW01F
	<input checked="" type="checkbox"/>	KG01F
	<input type="checkbox"/>	KM01F
HIGH BRIGHTNESS	<input type="checkbox"/>	KW01X
	<input checked="" type="checkbox"/>	KG01X
	<input type="checkbox"/>	KM01X

LIGHTABLE COVERS - 1 FUNCTION

		1 module
Description		Item
SHUTTERS UP/DOWN	<input type="checkbox"/>	KW05
	<input checked="" type="checkbox"/>	KG05
	<input type="checkbox"/>	KM05
SHUTTERS STOP	<input type="checkbox"/>	KW06MH
	<input checked="" type="checkbox"/>	KG06MH
	<input type="checkbox"/>	KM06MH

LIVING NOW KEY COVERS

COVERS FOR ACTUATOR ITEM K4672M2L AND CONTROL ITEM K4652M2



COVERS FOR ACTUATOR ITEM K4672M2S AND CONTROLS ITEM K4652M2



LIGHTABLE COVERS - 1 FUNCTION

		2 modules
Description		Item
UP/DOWN	<input type="checkbox"/>	KW05MH2
	<input checked="" type="checkbox"/>	KG05MH2
	<input type="checkbox"/>	KM05MH2

COVERS FOR GREEN SWITCH ITEM K4659



LIGHTABLE COVERS - 1 FUNCTION

		2 modules
Description		Item
NEUTRAL	<input type="checkbox"/>	KW01MH2
	<input checked="" type="checkbox"/>	KG01MH2
	<input type="checkbox"/>	KM01MH2
ON/OFF	<input type="checkbox"/>	KW01MH2AG
	<input checked="" type="checkbox"/>	KG01MH2AG
	<input type="checkbox"/>	KM01MH2AG
+/- FOR DIMMER	<input type="checkbox"/>	KW19MH2
	<input checked="" type="checkbox"/>	KG19MH2
	<input type="checkbox"/>	KM19MH2
LIGHT/WAKE UP	<input type="checkbox"/>	KW01MH2A
	<input checked="" type="checkbox"/>	KG01MH2A
	<input type="checkbox"/>	KM01MH2A
OUTPUT	<input type="checkbox"/>	KW01MH2GEN
	<input checked="" type="checkbox"/>	KG01MH2GEN
	<input type="checkbox"/>	KM01MH2GEN
COMING IN	<input type="checkbox"/>	KW01MH2BACK
	<input checked="" type="checkbox"/>	KG01MH2BACK
	<input type="checkbox"/>	KM01MH2BACK
BED	<input type="checkbox"/>	KW01MH2BED
	<input checked="" type="checkbox"/>	KG01MH2BED
	<input type="checkbox"/>	KM01MH2BED
DOORBELL	<input type="checkbox"/>	KW01MH2D
	<input checked="" type="checkbox"/>	KG01MH2D
	<input type="checkbox"/>	KM01MH2D
KEY	<input type="checkbox"/>	KW01MH2F
	<input checked="" type="checkbox"/>	KG01MH2F
	<input type="checkbox"/>	KM01MH2F
HIGH BRIGHTNESS	<input type="checkbox"/>	KW01MH2X
	<input checked="" type="checkbox"/>	KG01MH2
	<input type="checkbox"/>	KM01MH2X

		2 modules
		Item
<input type="checkbox"/>		KW17
<input checked="" type="checkbox"/>		KG17
<input type="checkbox"/>		KM17

COVERS FOR BURGLAR-ALARM ACTIVATOR ITEM K4215



		1 module
		Item
<input type="checkbox"/>		KW24
<input checked="" type="checkbox"/>		KG24
<input type="checkbox"/>		KM24

OTHER KEY COVERS

2-FUNCTION NON-SILK-SCREEN PRINTED KEY COVERS



2-FUNCTION NON-SILK-SCREEN PRINTED KEY COVERS



NON-SILK-SCREEN PRINTED KEY COVERS - 1 FUNCTION

	1 module	2 modules
	Item	Item
Axolute		
<input type="checkbox"/>	HD4915	HD4915M2
<input type="checkbox"/>	HC4915	HC4915/2
<input type="checkbox"/>	HS4915	HS4915/2
Livinglight		
<input type="checkbox"/>	N4915LN	N4915M2LN
<input type="checkbox"/>	NT4915N	NT4915M2N
<input type="checkbox"/>	L4915N	L4915M2N
Matic		
<input type="checkbox"/>	AM5911*	AM5911/2*

NON-SILK-SCREEN PRINTED KEY COVERS - 2 FUNCTIONS

	1 module	2 modules
	Item	Item
Axolute		
<input type="checkbox"/>	HD4911	HD4911M2
<input type="checkbox"/>	HC4911	HC4911/2
<input type="checkbox"/>	HS4911	HS4911/2
Livinglight		
<input type="checkbox"/>	N4911N	N4911M2N
<input type="checkbox"/>	NT4911N	NT4911M2N
<input type="checkbox"/>	L4911N	L4911M2N
Matic		
<input type="checkbox"/>	AM5911*	AM5911/2*

* key cover that can be used for 1 and 2 functions

NOTE: the control keys are supplied with the device.

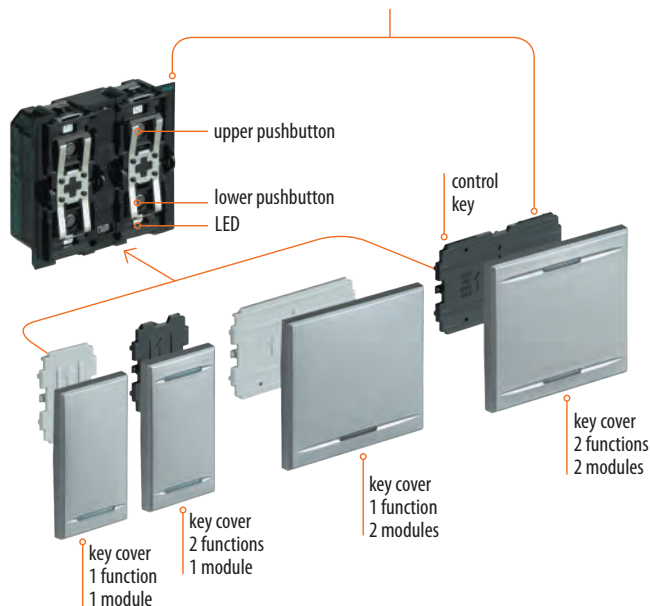

1-FUNCTION SILK-SCREEN PRINTED KEY COVERS

Axolute



HD4915AA HC4915/2AA HS4915BA

Livinglight



NT4915AN NT4915M2ADN NT4915MR

Màtix



AM5915AC AM5915/2AA AM5915BA

SILK-SCREEN PRINTED KEY COVERS WITH SYMBOLS - 1 FUNCTION

		Axolute		Livinglight		Màtix	
		1 module	2 modules	1 module	2 modules	1 module	2 modules
Description		Item	Item	Item	Item	Item	Item
OFF	<input type="checkbox"/>	HD4915AA	HD4915M2AA	—	—	AM5915AA	AM5915/2AA
	<input type="checkbox"/>	HC4915AA	HC4915/2AA	—	—		
	<input type="checkbox"/>	HS4915AA	HS4915/2AA	—	—		
ON	<input type="checkbox"/>	HD4915AB	HD4915M2AB	—	—	AM5915AB	AM5915/2AB
	<input type="checkbox"/>	HC4915AB	HC4915/2AB	—	—		
	<input type="checkbox"/>	HS4915AB	HS4915/2AB	—	—		
GEN	<input type="checkbox"/>	HD4915AC	HD4915M2AC	—	—	AM5915AC	AM5915/2AC
	<input type="checkbox"/>	HC4915AC	HC4915/2AC	—	—		
	<input type="checkbox"/>	HS4915AC	HS4915/2AC	—	—		
DIMMER	<input type="checkbox"/>	HD4915AD	HD4915M2AD	—	N4915M2ADN	AM5915AD	AM5915/2AD
	<input type="checkbox"/>	HC4915AD	HC4915/2AD	—	NT4915M2ADN		
	<input type="checkbox"/>	HS4915AD	HS4915/2AD	—	L4915M2ADN		
STOP	<input type="checkbox"/>	HD4915AE	—	N4915AEN	—	AM5915AE	—
	<input type="checkbox"/>	HC4915AE	—	NT4915AEN	—		
	<input type="checkbox"/>	HS4915AE	—	L4915AEN	—		
LIGHT	<input type="checkbox"/>	HD4915BA	HD4915M2BA	N4915AN	N4915M2AN	AM5915BA	AM5915/2BA
	<input type="checkbox"/>	HC4915BA	HC4915/2BA	NT4915AN	NT4915M2AN		
	<input type="checkbox"/>	HS4915BA	HS4915/2BA	L4915AN	L4915M2AN		
STAIRCASE LIGHT	<input type="checkbox"/>	—	—	N4915BN	N4915M2BN	—	—
	<input type="checkbox"/>	—	—	NT4915BN	NT4915M2BN	—	—
	<input type="checkbox"/>	—	—	L4915BN	L4915M2BN	—	—
BED LIGHT	<input type="checkbox"/>	HD4915BL	HD4915M2BL	—	—	—	—
	<input type="checkbox"/>	HC4915BL	HC4915M2BL	—	—	—	—
	<input type="checkbox"/>	HS4915BL	HS4915M2BL	—	—	—	—
BELL	<input type="checkbox"/>	HD4915BB	HD4915M2BB	—	—	AM5915BB	—
	<input type="checkbox"/>	HC4915BB	HC4915/2BB	—	—		
	<input type="checkbox"/>	HS4915BB	HS4915/2BB	—	—		
EXHAUST FAN	<input type="checkbox"/>	HD4915BC	HD4915M2BC	—	—	—	—
	<input type="checkbox"/>	HC4915BC	HC4915/2BC	—	—		
	<input type="checkbox"/>	HS4915BC	HS4915/2BC	—	—		
KEY	<input type="checkbox"/>	HD4915BD	—	N4915FN	N4915M2FN	AM5915BD	—
	<input type="checkbox"/>	HC4915BD	—	NT4915FN	NT4915M2FN		
	<input type="checkbox"/>	HS4915BD	—	L4915FN	L4915M2FN		
DO NOT DISTURB	<input type="checkbox"/>	HD4915DD	HD4915M2DD	N4915DD	N4915M2DD	—	—
	<input type="checkbox"/>	HC4915DD	HC4915M2DD	NT4915DD	NT4915M2DD	—	—
	<input type="checkbox"/>	HS4915DD	HS4915M2DD	L4915DD	L4915M2DD	—	—
DOORBELL	<input type="checkbox"/>	—	—	N4915DN	N4915M2DN	—	—
	<input type="checkbox"/>	—	—	NT4915DN	NT4915M2DN	—	—
	<input type="checkbox"/>	—	—	L4915DN	L4915M2DN	—	—
MAKE UP THE ROOM	<input type="checkbox"/>	HD4915MR	—	N4915MR	—	—	—
	<input type="checkbox"/>	HC4915MR	—	NT4915MR	—	—	—
	<input type="checkbox"/>	HS4915MR	—	L4915MR	—	—	—

OTHER KEY COVERS

2-FUNCTION SILK-SCREEN PRINTED KEY COVERS

Axolute



HD4911AF HD4911MAF HC4911BC

Livinglight



NT4911AHN NT4911AIN

Màtix



AM5911AF AM5911AI

SILK-SCREEN PRINTED KEY COVERS WITH SYMBOLS - 2 FUNCTIONS

		Axolute		Livinglight		Màtix	
		1 module	2 modules	1 module	2 modules	1 module	2 modules
Description		Item	Item	Item	Item	Item	Item
ON - OFF - GEN	<input type="checkbox"/>	HD4911AF	HD4911M2AF	N4911AFN	N4911M2AFN	AM5911AF (*)	AM5911/2AF
	<input type="checkbox"/>	HC4911AF	HC4911/2AF	NT4911AFN	NT4911M2AFN		
	<input type="checkbox"/>	HS4911AF	HS4911/2AF	L4911AFN	L4911M2AFN		
ON - OFF	<input type="checkbox"/>	HD4911AG	HD4911M2AG	N4911AGN	N4911M2AGN	AM5911AG	AM5911/2AG
	<input type="checkbox"/>	HC4911AG	HC4911/2AG	NT4911AGN	NT4911M2AGN		
	<input type="checkbox"/>	HS4911AG	HS4911/2AG	L4911AGN	L4911M2AGN		
UP - DOWN	<input type="checkbox"/>	HD4911AH	HD4911M2AH	N4911AHN	N4911M2AHN	AM5911AH	AM5911/2AH
	<input type="checkbox"/>	HC4911AH	HC4911/2AH	NT4911AHN	NT4911M2AHN		
	<input type="checkbox"/>	HS4911AH	HS4911/2AH	L4911AHN	L4911M2AHN		
ON - OFF ADJUSTMENT	<input type="checkbox"/>	HD4911AI	HD4911M2AI	N4911AIN	N4911M2AIN	AM5911AI (*)	AM5911/2AI
	<input type="checkbox"/>	HC4911AI	HC4911/2AI	NT4911AIN	NT4911M2AIN		
	<input type="checkbox"/>	HS4911AI	HS4911/2AI	L4911AIN	L4911M2AIN		
LIGHT	<input type="checkbox"/>	HD4911BA	HD4911M2BA	—	—	—	—
	<input type="checkbox"/>	HC4911BA	HC4911/2BA	—	—	—	—
	<input type="checkbox"/>	HS4911BA	HS4911/2BA	—	—	—	—
EXHAUST FAN	<input type="checkbox"/>	HD4911BC	HD4911M2BC	—	—	—	—
	<input type="checkbox"/>	HC4911BC	HC4911/2BC	—	—	—	—
	<input type="checkbox"/>	HS4911BC	HS4911/2BC	—	—	—	—
TREBLE CLEF	<input type="checkbox"/>	HD4911BE	—	—	—	—	—
	<input type="checkbox"/>	HC4911BE	—	—	—	—	—
	<input type="checkbox"/>	HS4911BE	—	—	—	—	—
+ up and - down	<input type="checkbox"/>	HD4911AD	—	N4911ADN	—	—	—
	<input type="checkbox"/>	HC4911AD	—	NT4911ADN	—	—	—
	<input type="checkbox"/>	HS4911AD	—	L4911ADN	—	—	—

NOTE (*): key covers also suitable for use with Sound System devices

CUSTOMISABLE LIVINGLIGHT KEY COVERS WITH DIFFUSERS, AVAILABLE IN KIT

CUSTOMISABLE KEY COVERS			
		1 module	2 modules
Description		Item	Item
1 FUNCTION CUSTOMISABLE KEY COVER WITH 1 DIFFUSER*	<input type="checkbox"/>	N4915TN	N4915M2TN
	<input type="checkbox"/>	NT4915TN	NT4915M2TN
	<input type="checkbox"/>	L4915TN	L4915M2TN
2 FUNCTION CUSTOMISABLE KEY COVER WITH 2 DIFFUSERS*	<input type="checkbox"/>	N4911TN	N4911M2TN
	<input type="checkbox"/>	NT4911TN	NT4911M2TN
	<input type="checkbox"/>	L4911TN	L4911M2TN

1 FUNCTION

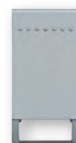

Customisable with 1 diffuser

2 FUNCTIONS



Customisable with 2 diffusers

DIFFUSER KIT		
Description	Item	
KIT WITH DIFFUSER ON THE SIDE (50 DIFFUSERS)	<input type="checkbox"/>	N4915SETBL
	<input type="checkbox"/>	NT4915SETBL
	<input type="checkbox"/>	L4915SETBL



MyHOME FLATWALL

BASE, DEVICE HOLDER SUPPORTS AND ACCESSORIES



Item	BASIC MODULE FOR WALLS
3750	basic module h 240 - 270 cm, for masonry walls made up of: lower module bottom, telescopic module bottom, upper end cap, bracket with adjustable feet, cable fastener plate and masonry net
3751	module as above, for plasterboard walls
3823	flush mounted module h 150 cm for masonry and plasterboard walls



Item	DEVICE HOLDER SUPPORTS AND ACCESSORIES
3787	device holder support h 30 cm max 36 DIN mod.
3788	device holder support for free fastening of non-DIN devices or for cable fastening in the riser solution
3789	device holder support h 60 cm max 72 DIN mod.
3801	mounting bracket for 1 or 2 MyHOME devices - 506E modularity
3802	mounting bracket for 3 MyHOME devices - 506E modularity
3805	pair of brackets for non-modular central units
3790	pair of kits with trunking and DIN rails for 3788
3756	horizontal partition (optional)
3803	extension module. To be used as a connector when passing between floors. It is indispensable to use it in the riser solution
3804	vertical partition h 300 cm to separate the cables in the riser solution
3828	multimedia box to be completed with appropriate clips F496/MF
3831	cable entry kit for multimedia box

MyHOME FLATWALL

FINISHES



Item	PANELS
3794N	front cover panel h 120 cm for 1 device with 506E modularity
3795N	front cover panel h 120 cm for 2 devices with 506E modularity
3796N	front cover panel h 120 cm for 3 devices with 506E modularity
3791N	front cover panel h 30 cm for 1 device with 506E modularity
3792N	front cover panel h 30 cm for 2 devices with 506E modularity
3793N	front cover panel h 30 cm for 3 devices with 506E modularity
3797*	DIN switchboard h 30 cm - glass
3798*	DIN switchboard h 30 cm - metal sheet
3829	Multimedia box panel h 30 cm
3799*	DIN switchboard h 30 cm - plastic
3757	front cover panel h 30 cm
3759	front cover panel h 60 cm
3785	front cover panel h 90 cm
3786	front cover panel h 120 cm
3771	upper and lower finishing end caps for 240 and 270 version
3825	upper and lower finishing end caps for 150 version
3761**	front cover panel for non-modular central units
3769	front cover panel h 60 cm for burglar alarm

* Provide some white blanking modules F215FP, to close any internal empty compartments
 ** Provide some white blanking modules 16133, to close any empty compartments

Item	FRAMES AND PROFILES
3817N	frame for AXOLUTE items
3818N	frame for LIVING items
3821	side finishing profiles h 270 cm
3822	side finishing profiles h 240 cm
3826	side finishing profiles h 150 cm

ASSEMBLY GUIDE: MyHOME FLATWALL 240 - 270 AS SWITCHBOARD

BASIC SETUP: BOTTOM



3750
Flush mounted bottom

3751
Flush mounted bottom
for plasterboard
(without masonry net)

DEVICE HOLDER SUPPORTS AND ACCESSORIES



3787
Device holder support
h 30 cm max 36 DIN mod.



3789
Device holder support
h 60 cm max 72 DIN mod.



3788
Device holder support for
free fastening of non-DIN
devices



3790
Pair of kits with
trunking and DIN rails
for 3788 (optional)



3787
Device holder support
h 30 cm max 36 DIN mod.



3756
Horizontal partition
(optional)



3828
Multimedia equipment box
F496/MF
Clips



3805
Support bracket
for non-modular
central units

SUPPORTS FOR MyHOME DEVICES WITH 506E MODULARITY



3802
Mounting bracket
3 devices



3801
Mounting bracket
1 or 2 devices



Power supplies and other devices
MyHOME DIN module



DIN protective devices



3550
Temperature
control central unit



3486
GSM burglar-alarm
central unit

FINISHINGS: PANELS FOR DEVICES WITH 506E MODULARITY, END CAPS AND FRAMES***

SIDE FRAME FINISHING



3794N
Front cover plate
h 120 cm for one device



3795N
Front cover plate
h 120 cm for two devices



3796N
Front cover plate
h 120 cm for three devices



3817N
Frames for
AXOLUTE items



3818N
Frames for
LIVING items



3791N
Front cover plate
as above h 30 cm



3792N
Front cover plate
as above h 30 cm



3793N
Front cover plate
as above h 30 cm



3797**
DIN switchboard
h 30 cm - glass



3798**
DIN switchboard
h 30 cm - metal sheet



3799**
DIN switchboard
h 30 cm - plastic



3829
Multimedia
box panel
h 30 cm



3757
Front cover plate
h 30 cm



3759
Front cover plate
h 60 cm



3785
Front cover plate
h 90 cm



3786
Front cover plate
h 120 cm



3771
Upper and lower finishing end caps
(to be fitted last)



3761
Front cover panel for
non-modular central
units*



3821
3822
Side finishing frames
h 270 cm and
h 240 cm

* Provide some white blanking modules 16133, to close any empty compartments
** Provide some white blanking modules F215FP to close any internal empty compartments
*** Panels and end cap must always be installed after the side finishing frames (3821 or 3822).

ASSEMBLY GUIDE: MyHOME FLATWALL 150 AS SWITCHBOARD

BASIC SETUP: BOTTOM



3823
Flush mounted bottom

DEVICE HOLDER SUPPORTS AND ACCESSORIES



3787
Device holder support
h 30 cm max 36 DIN mod.



3789
Device holder support
h 60 cm max 72 DIN mod.



3788
Device holder support for
free fastening of non-DIN
devices



3790
Pair of kits with trunking
and DIN rails for 3788
(optional)



3787
Device holder support
h 30 cm max 36 DIN mod.



3756
horizontal partition
(optional)



3828
Multimedia equipment box
F496/MF
Clips



3805
Support bracket
for non-modular
central units

SUPPORTS FOR MyHOME DEVICES 506E MODULARITY



3802
Mounting bracket
for 3 devices



3801
Mounting bracket
for 1 or 2 devices



Power supplies and other MyHOME devices
DIN module



DIN protective devices



3550
Temperature
control central unit



3486
GSM burglar-alarm
central unit

FINISHINGS: PANELS FOR DEVICES WITH 506E MODULARITY, END CAPS AND FRAMES***

SIDE FRAME FINISHING



3791N
Front cover plate
h 30 cm for one device



3792N
Front cover plate
h 30 cm for two devices



3793N
Front cover plate
h 30 cm for three devices



3817N
Frames for
AXOLUTE items



3818N
Frames for
LIVING items



3797**
DIN switchboard
h 30 cm - glass



3798**
DIN switchboard
h 30 cm - metal sheet



3799**
DIN switchboard
h 30 cm - plastic



3829
Multimedia
box panel
h 30 cm



3757
Front cover plate
h 30 cm



3759
Front cover plate
h 60 cm



3785
Front cover plate
h 90 cm



3825
Upper and lower finishing
end caps (to be fitted
before front cover panels)



3761
Front cover panel for
non-modular central
units*



3826
side finishing frames
h 150 cm

* Provide some white blanking modules 16133, to close any empty compartments

** Provide some white blanking modules F215FP to close any internal empty compartments

*** Panels and end cap must always be installed after the side finishing frames (3821 or 3822).

ASSEMBLY GUIDE: MYHOME FLATWALL 240 - 270 AS ELECTRIC PANEL

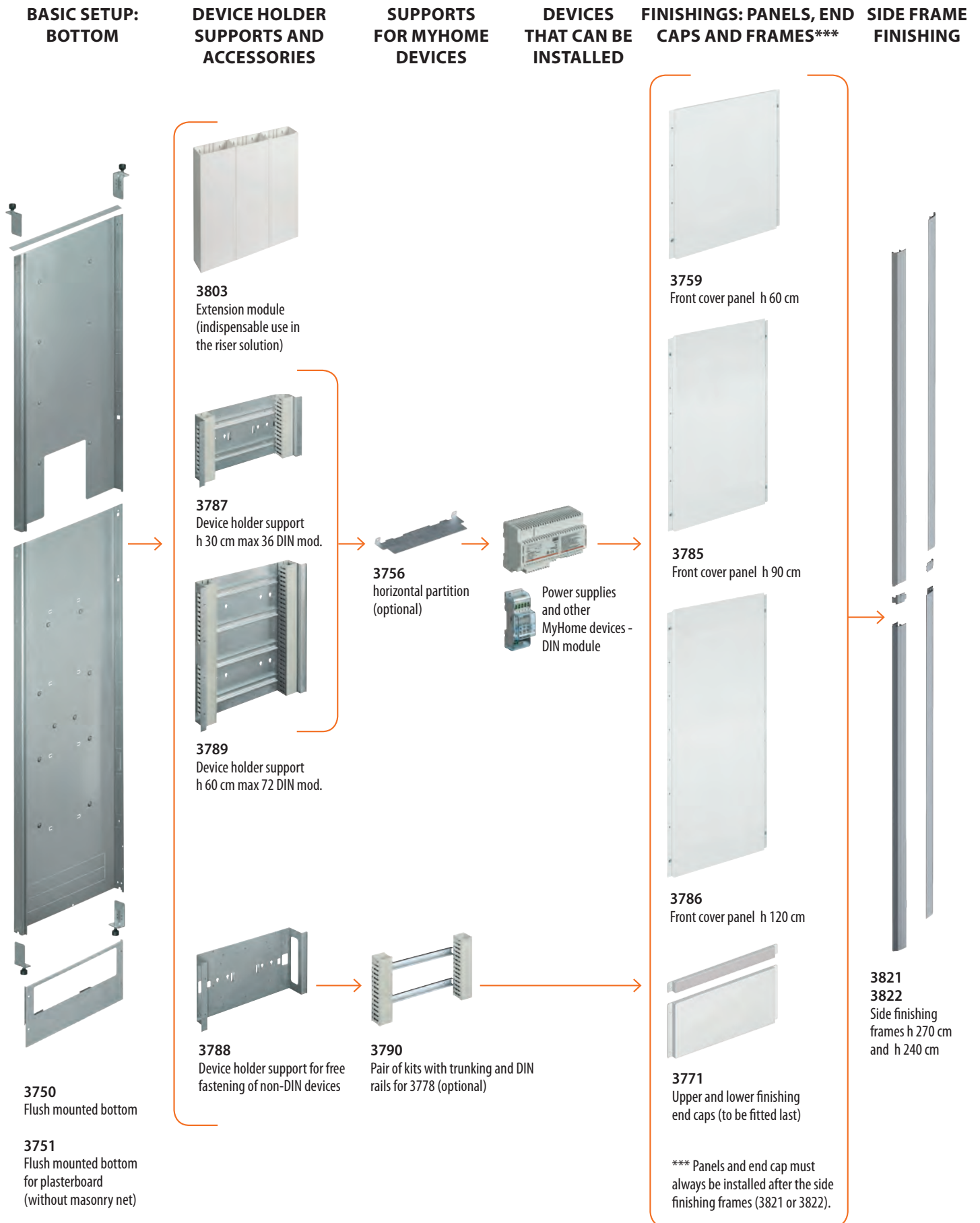

ASSEMBLY GUIDE: MyHOME FLATWALL 150 AS ELECTRIC PANEL

**BASIC SETUP:
BOTTOM**

**DEVICE HOLDER
SUPPORTS AND
ACCESSORIES**

**SUPPORTS
FOR MY HOME
DEVICES**

**DEVICES THAT CAN
BE INSTALLED**

**FINISHINGS:
PANELS, END CAPS
AND FRAMES*****

**SIDE FRAME
FINISHING**

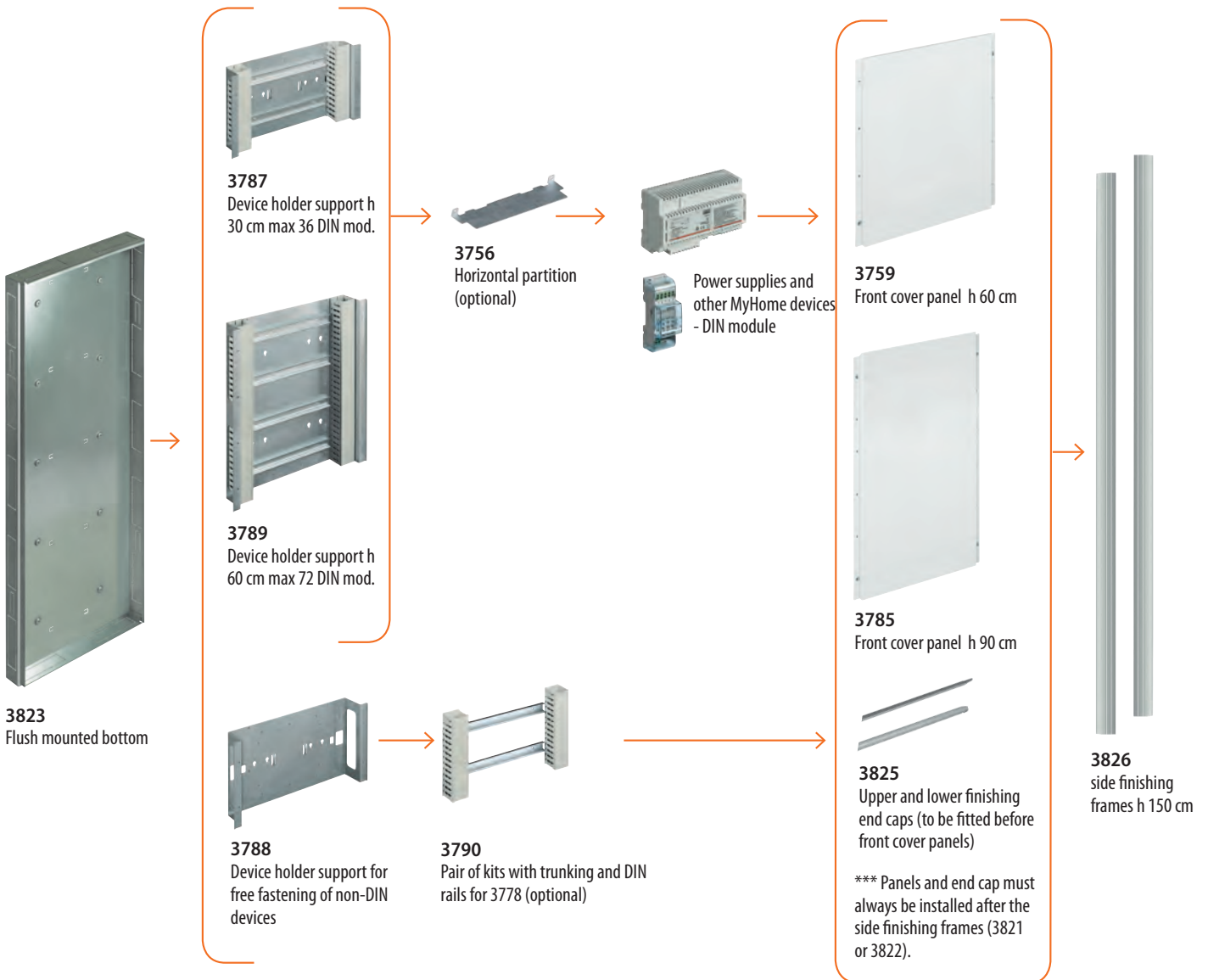

ASSEMBLY GUIDE: MyHOME FLATWALL 240 - 270 AS FLOOR RISER

BASIC SETUP: BOTTOM



3750
Flush mounted bottom

3751
Flush mounted bottom
for plasterboard
(without masonry net)

BRACKETS AND ACCESSORIES



3803
Extension module
(indispensable use in
the riser solution)



3788
Device holder support
for cable fastening

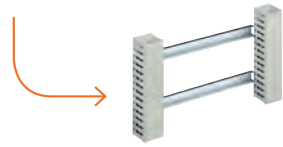

3790
Pair of kits with trunking
and DIN rails for **3778**
(optional)



3804
Vertical
partition
h 300 cm

FINISHINGS: PANELS AND END CAPS ***



3759
Front cover plate
h 60 cm



3785
Front cover plate
h 90 cm



3771
Upper and lower
finishing end caps (to be
fitted last)



3786
Front cover plate
h 120 cm

*** Panels and end cap
must always be installed
after the side finishing
frames (3821 or 3822).

SIDE FRAME FINISHING

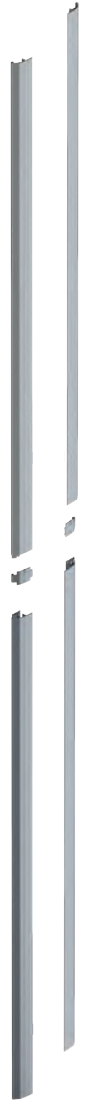

3821
3822
Side finishing frames
h 270 cm
and h 240 cm

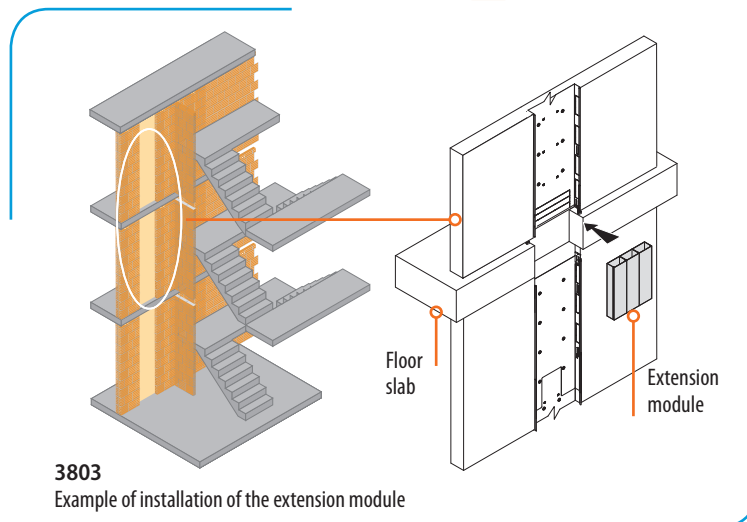

3803
Example of installation of the extension module

COMPOSITION EXAMPLE

Composition with switchboard for protective devices h 270 cm.

Bottom modularity

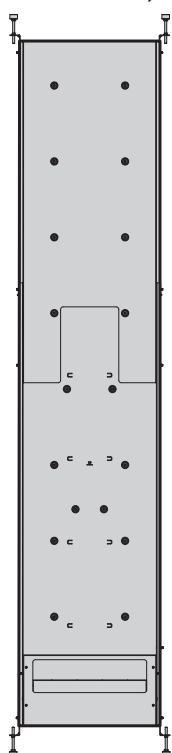

View of the completed product

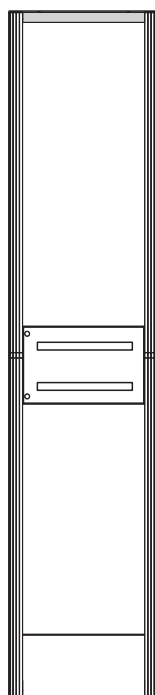

Item	LIST OF THE MATERIAL	Quantity
3750	Flush mounted bottom	1
3789	Device holder support h 60 cm	4
3786	Front cover panel h 120 cm	1
3785	Front cover panel h 90 cm	1
3797	DIN switchboard h 30 cm - glass	1
3821	Pair of side frames h 270 cm	1
3771	Upper and lower finishing end caps	1

Composition with switchboard for protective devices h 240 cm.

Bottom modularity

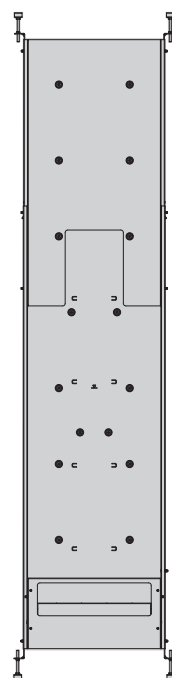

View of the completed product

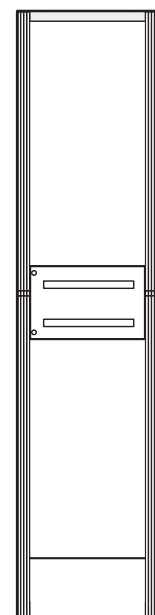

Item	LIST OF THE MATERIAL	Quantity
3750	Flush mounted bottom	1
3789	Device holder support h 60 cm	3
3787	Device holder support h 30 cm	1
3785	Front cover panel h 90 cm	2
3797	DIN switchboard h 30 cm - metal sheet	1
3822	Pair of side frames h 240 cm	1
3771	Upper and lower finishing end caps	1

MyHOME FLATWALL - DIMENSIONAL DATA

MyHOME FLATWALL 240 - 270

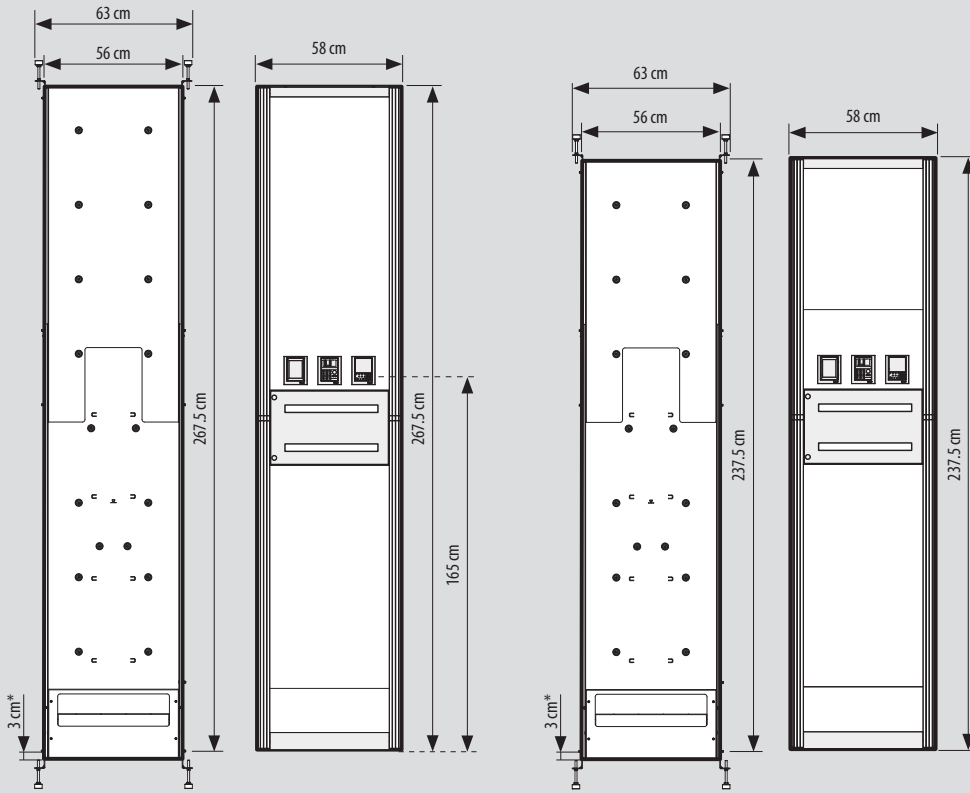

* Bottom part embedded in the floor only corresponding to the 3750 (not for 3751).

Thickness - top view with assembled components

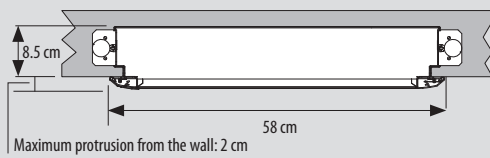

MyHOME FLATWALL 150

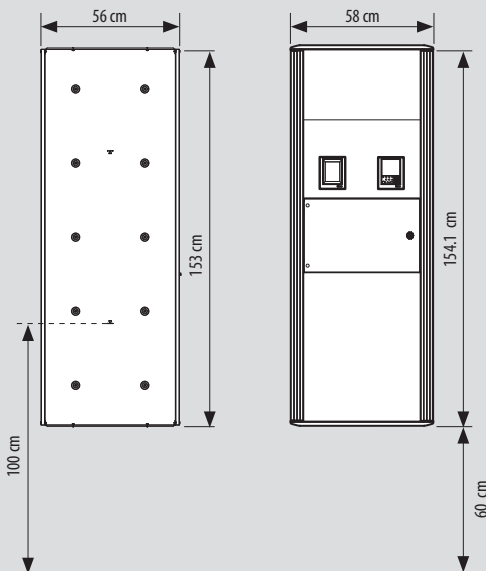

Thickness - top view with assembled components

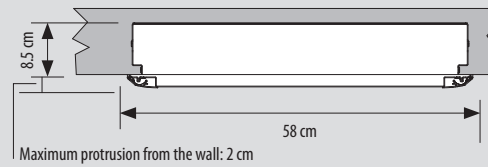

PANELS, SWITCHBOARDS, FINISHING END CAPS AND EXTENSION MODULE (PASSING BETWEEN FLOORS)

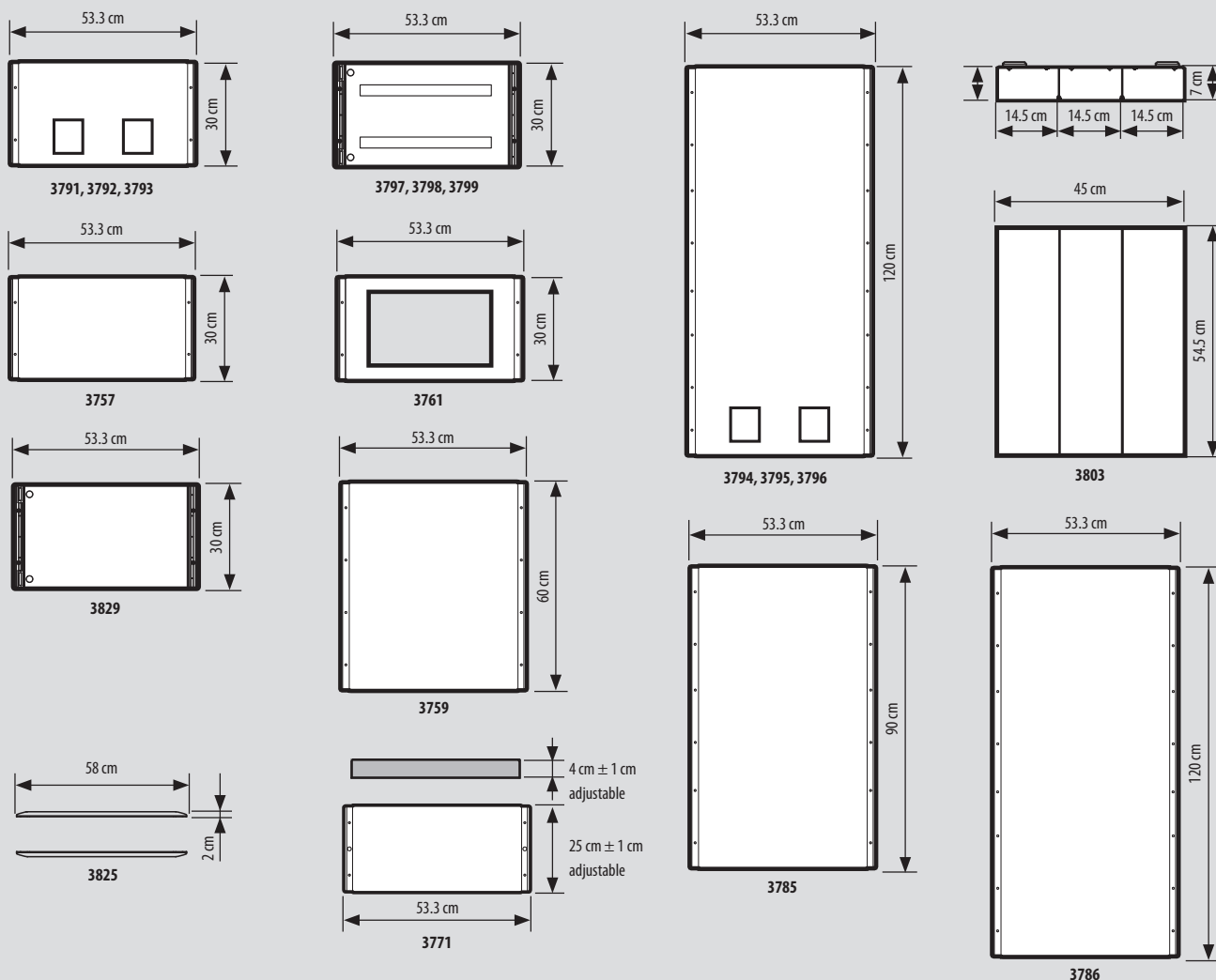

DEVICE HOLDER SUPPORTS

Max 72 DIN modules divided on 4 rows of 18 - Max 36 DIN modules divided on 2 rows of 18.

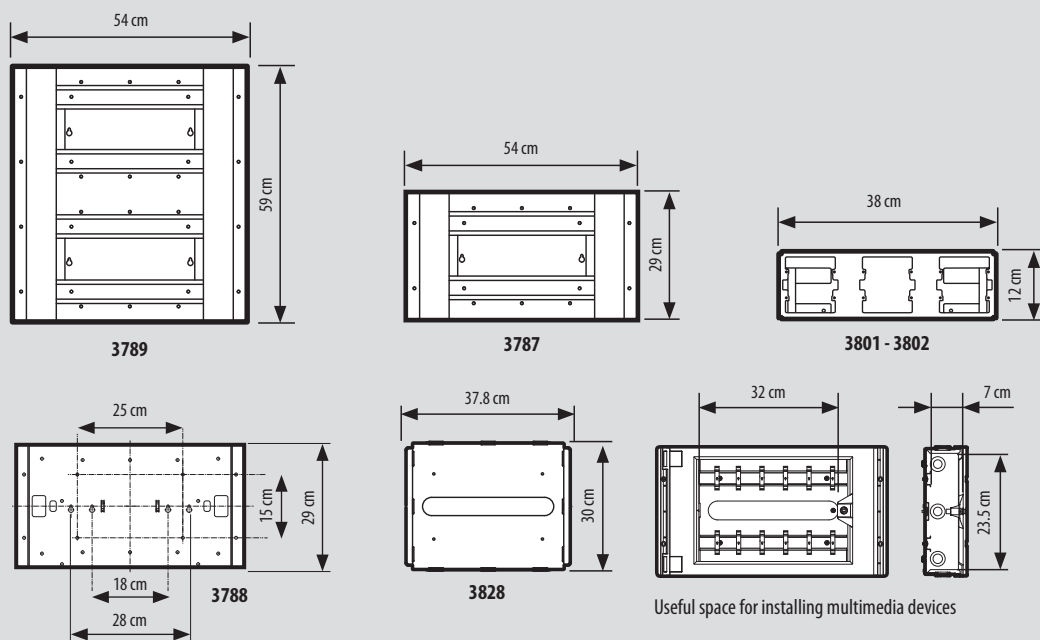

Devices which can be associated with the **MyHOME_Up** app and **MyHOMEServer1** gateway

The following pages provides the list of devices of the light and shutter Automation system and Temperature control system which are associated using **MyHOMEServer1** devices and **MyHOME_APP**. The Energy Management actuators are configured using **MyHome_Suite** software.

LIGHT AND AUTOMATION DEVICES THAT CAN BE ASSOCIATED

Description	BTicino Code	From production batch:	Channels configured automatically by MyHOMEServer1
Scenario control	L4680	09W08	
	N4680	09W08	
	NT4680	09W08	
	HC4680	09W08	
	HD4680	09W08	
	HS4680	09W08	
SCS/SCS interface	F422	12W20	
BUS 8-key control	LN4652	all	
	H4652	all	
2 m basic control	K4652M2	all	
	H4652/2	09W40	
	L4652/2	09W40	
	AM5832/22	09W40	
3 m basic control	K4652M3	all	
	L4652/3	09W40	
	H4652/3	09W40	
	AM5832/3	09W40	
Light actuator	K8002L	all	
BUS shutter actuator	LN4661M2	all	1
	H4661M2	all	1
	AM5861M2	all	1
	K8002S	all	
BUS shutter control	LN4660M2	all	
	H4660M2	all	
	AM5860M2	all	
Special control	L4651M2	08W41	
	H4651M2	08W41	
	AM5831M2	08W41	
16A 100/240V 1 relay DIN actuator	F411U1	all	1
16A 100/240V 2 relay DIN actuator	F411U2	all	2
16A 100/240V 1 relay DIN actuator	F411/1N	09W13	1
16A 2 relay DIN actuator	F411/2	09W04**	2
16A 100/240V 2 relay DIN actuator	BMSW1002	all	2
16A 100/240V 4 relay DIN actuator	BMSW1003	all	4
6A 4 relay DIN actuator	F411/4	09W04*	4
16A 100/240V 4 relay DIN actuator	BMSW1005	all	8
4 output DIN actuator for 0-10V ballast	BMDI1002	all	4
DIN actuator for 0-10V ballast	F413N	09W14	1
Basic contact interface	3477	10W04	
DIN contact interface	F428	09W50	

* If the device is installed on the output of the F422 interface, the minimum batch is 15W25

** If the device is installed on the output of the F422 interface, it is not possible to associate it using the APP.
It is recommended to replace it with the code F411U2

For the updated list of devices see the technical sheet of the gateway device item MyHOMEServer1.

Description	BTicino Code	From production batch:	Channels configured automatically by MyHOMEServer1
1000 VA DIN dimmer	F416U1	all	1
1000 W DIN dimmer	F414	09W29	1
400 VA DIN dimmer	F415	09W22	1
2 x 400 VA DIN dimmer	F417U2	all	2
300 VA DIN dimmer	F418	all	1
2 x 300 VA DIN dimmer	F418U2	all	2
3 m touch control	HC4657M3	11W09	
	HD4657M3	11W12	
	HS4657M3	11W12	
4 m touch control	HC4657M4	11W12	
	HD4657M4	11W12	
	HS4657M4	11W14	
SCS/DALI interface	F429	10W20	8
Basic actuator	3475	12W31	1
BUS shutter DIN actuator	F401	all	1
Control actuator	K4672M2L	all	2
	AM5852M2	all	2
	H4672M2	all	2
	LN4672M2	all	2
Basic control actuator	3476	12W39	1
Control actuator	K4672M2S	all	2
	LN4671M2	all	
DIN dimmer for 0-10 V ballast	BMDI1001	all	1
BUS Dual Tech Green Switch	L4658N	all	
	N4658N	all	
	NT4658N	all	
	HC4658	all	
	HD4658	all	
	HS4658	all	
	K4659	all	
PIR BUS automatic switch	L4659N	all	
	N4659N	all	
	NT4659N	all	
	HC4659	all	
	HD4659	all	
	HS4659	all	
PIR ceiling mounted sensor	BMSE3001	all	
PIR+US double technology ceiling mounted sensor	BMSE3003	all	
IP55 PIR wall mounted sensor			
Memory module	F425	10W01	
Control	K4652M2	all	
	K4652M3	all	

Devices which can be associated with the **MyHOME_Up** app and **MyHOMEServer1** gateway

TEMPERATURE CONTROL DEVICES

Description	BTicino code	From production batch:
Probe with Display	LN4691	all
	H4691	all
	KM4691	
	KG4691	
	KW4691	
Probe without display	3454	all
SLAVE probe	L4693	13W36
	N4693	13W36
	NT4693	13W36
	HC4693	13W36
	HS4693	13W36
	HD4693	13W36
DIN actuator with 2 independent relays	F430/2	13W06
DIN actuator with 4 independent relays	F430/4	13W06
DIN actuator with 8 independent relays	F430R8	all
DIN actuator with 2 0-10 V outputs	F430V10	all
DIN actuator with 3 independent relays and 2 0-10 V outputs	F430R3V10	all

NOTE 1: in the case of systems with 99-zone temperature control unit, the device configuration must be made by means of physical or virtual configuration. In this case, all the batches are compatible.

NOTA 2: for any updates of this table, see the Gateway MyHOMEServer1 technical sheet in the Catalogue section of the bticino.com site

BTicino SpA
Viale Borri, 231
21100 Varese - Italy
www.bticino.com



AD-EXMH21GT/GB

bticino

A Group brand |  **legrand**

BTicino SpA reserves at any time the right to modify the contents of this booklet and to communicate, in any form and modality, the changes brought to the same.

AD-EXMH21GT/GB - Version 02/2021