



Classe 300X

Installation Manual

bticino



Contents

General information	4
Warnings and recommendations	4
Front view	5
Rear view	7
Dimensional data and installation heights	8
Wall-mounted installation	9
Installation on the table-top base	10
Physical configuration	12
Configurators	13
Functions of the M units configurator (Favorites key)	14
Functions of the M tenths configurator (Quick actions)	15
First switching on	19
Settings	22
General settings	22
Ringtones	32
Display	33
Answering machine	35
Quick actions	37
Configuration	39
Advanced Configuration	44
First switching on	44
Configuration	47
General settings	52
Intercom	52
Camera	54
Activation	56
Quick actions	58
Factory configuration	60
TROUBLESHOOTING	61

General information

Warnings and recommendations

It is important to read this manual carefully before proceeding with the installation.

The guarantee automatically expires for negligence, misuse, tampering by unauthorized personnel.

The Classe 300X Video internal unit must only be installed indoors; it must not be exposed to water drops or splashes; it must be used only on BTicino 2 wire digital systems.

The Classe 300X video internal unit must be connected to a Wi-Fi network with the following features:

- IEEE 802.11 b/g/n (2,4 GHz) 13 canali
- Metodo di criptazione ed autenticazione supportati:
 - IEEE 802.11 b/g/n (2,4 GHz) 13 channels
 - Encrypting and authentication methods supported:
 - OPEN WPA-PSK networks
 - TKIP WPA2-PSK included
 - included AES WEP 64 bits (ASCII 5 figure or hexadecimal 10 figure codes)
 - WEP 128 bits (ASCII 13 figure or hexadecimal 26 figure codes)
 - WPS authentication (supported for WPA2-PSK)

NOTE: a domestic Wi-Fi with internet access is needed for the connection between the Classe 300X video internal unit and the smartphone.

To use the service, the Customer must acquire the technical equipment which allows access to the Internet, on the basis of an agreement made by the Customer himself with an ISP (Internet Service Provider). BTicino plays no part in this.

The customer must install the [DOOR ENTRY APP](#) on his smartphone so that he can use some services which BTicino supplies as extras to the normal basic functions of the Classe 300X.

The services offered by means of the APP require being able to interact with Classe 300X remotely and through the Internet.

In these cases the integration and good working between Classe 300X and APP may depend on:

- a) quality of the Wi-Fi signal;
- b) type of access contract to the home internet;
- c) type of data contract on the smartphone.

When one of these 3 elements does not conform with the specifications required for product operation, BTicino accepts no responsibility for any faults.

The product in fact supports a VoIP streaming system. You must therefore check with your smartphone data network contract that it does not block it.

We would like to inform you that the service provided by BTicino by means of remote use via the APP involves the use of data. The cost linked to data usage depends on the type of contract which the customer has with his ISP (Internet Service Provider) and is solely the customer's responsibility.



Hello, my name is BTTrick and my job is to help you with the device configuration.

In this manual the standard configurations are simple and well explained, but I want to teach you the "tricks" to use your new Classe 300X at its best.

When you find the symbol , move the mouse over it.

Front view

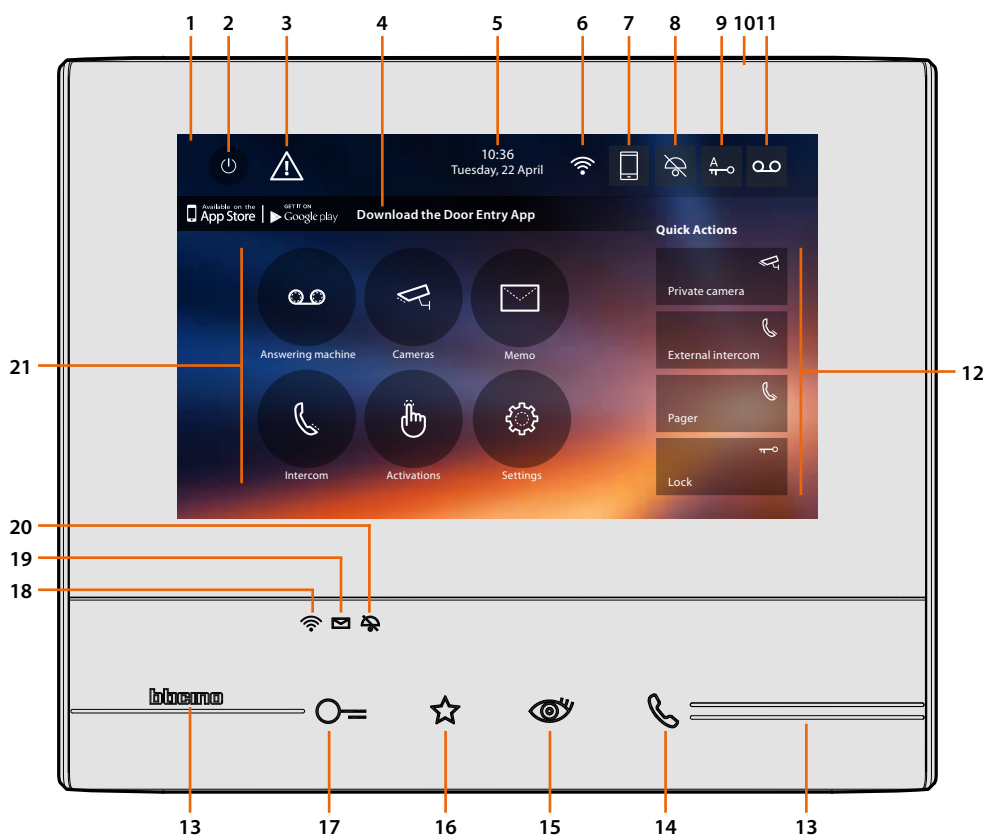

Note: The image* shows the device with all its functions enabled.
In this manual check how to enable them.

*The background and icons shown may differ from those on the device.

1. 7" touch screen display (16 : 9)
2. Screen OFF key
3. If this symbol appears, [date and time must be updated](#)
4. App:
touch to display the [information](#) page where you find a QR code that allows the download of the [DOOR ENTRY APP](#) to interact with your device.
It is possible to disable the [information](#) page display.
5. Time and date
6. Wi-Fi Connection
7. Device/APP association and enabled/disabled forwarding of calls
8. Ringtone exclusion
9. Professional Studio (Office) activation
10. Microphone
11. Answering machine activation
12. Quick actions
13. Tactile guides
14. Connection key:
The green LED flashes to indicate an incoming call
The green LED comes on steady to indicate that there is an active call
15. Auto-switching on/Scrolling:
the red LED turns on when the key is pressed

- 16. Favorites key:
the red LED turns on when the key is pressed
(Basic configuration = STAIRCASE LIGHT. For a different configuration refer to the physical configuration [table](#))
- 17. Door lock release key:
the red LED turns on when the key is pressed
- 18. Wi-Fi Status:
Red LED flashing = Wi-Fi is active but not connected to a network
LED off = disabled or properly functioning Wi-Fi
Green LED steady = the Classe 300X is exchanging data with the [DOOR ENTRY APP](#) (forwarding of call, auto-switching on)

Note: when the [DOOR ENTRY APP](#) is connected to the system (e.g. answer a call, display an Entrance Panel, etc.), no operations can be made, with the exception of the door lock release key and Favorite Key (configured for the Staircase Light or Door Lock Direct Control functions) that continue to operate.

- 19. Message status:
Red LED flashing = new unread note/s or message/s in the answering machine
- 20. Bell exclusion Status:
Red LED on = Call ringtone disabled
- 21. Functions (only the icons for the configured functions are displayed)

Rear view

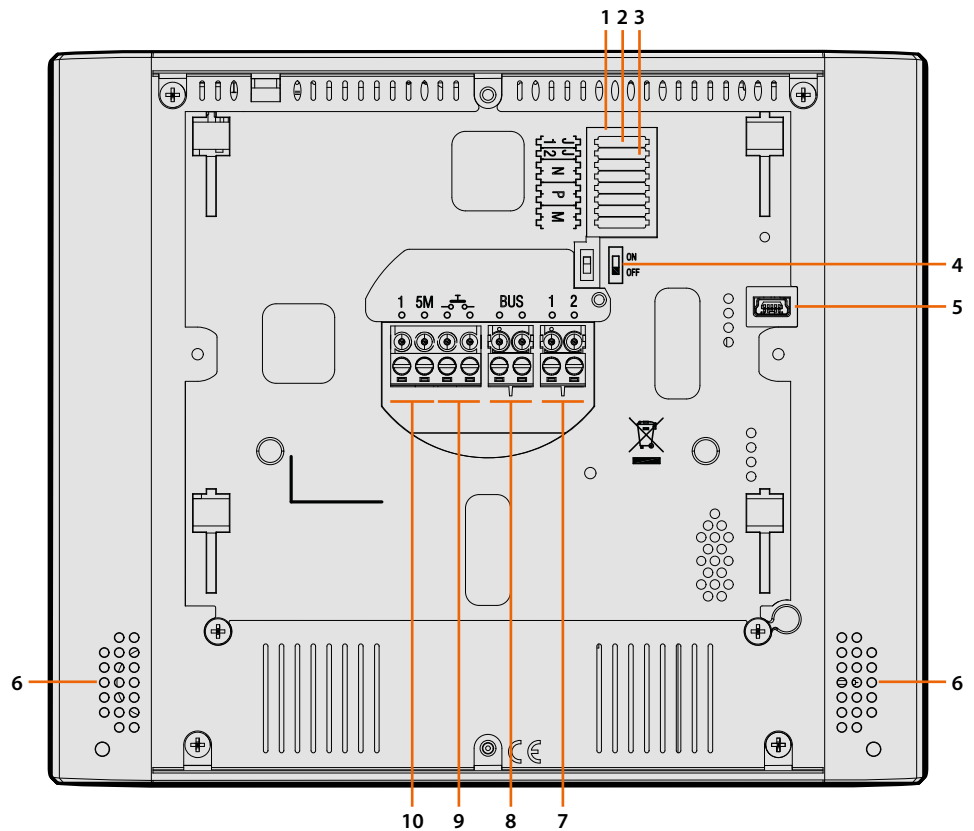

1. Configurator socket
2. Configurator J1: Remove if the additional power supply is present (clamp 1 and 2)
3. Configurator J2: for correct operation do not remove
4. Line termination ON/OFF micro-switch
5. Mini USB socket for device Firmware update using the MyHomeSuite software
Note: the device must be powered (1-2 or BUS)
6. Loudspeaker
7. Additional power supply clamps (1 - 2)
8. 2 WIRE SCS/BUS connection clamps
9. Clamps (-) for the connection of an external call to the floor pushbutton
10. Additional ringtone connection clamps (1 - 5M)
Point-to-Point connections are required on the clamps of the additional ringtones

Dimensional data and installation heights

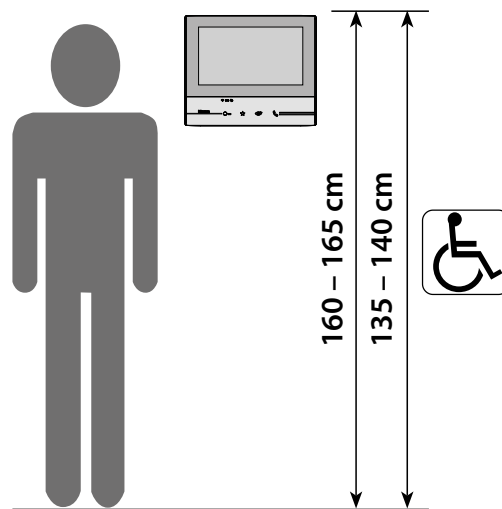

Altezza consigliata salvo diversa normativa vigente

Wall-mounted installation

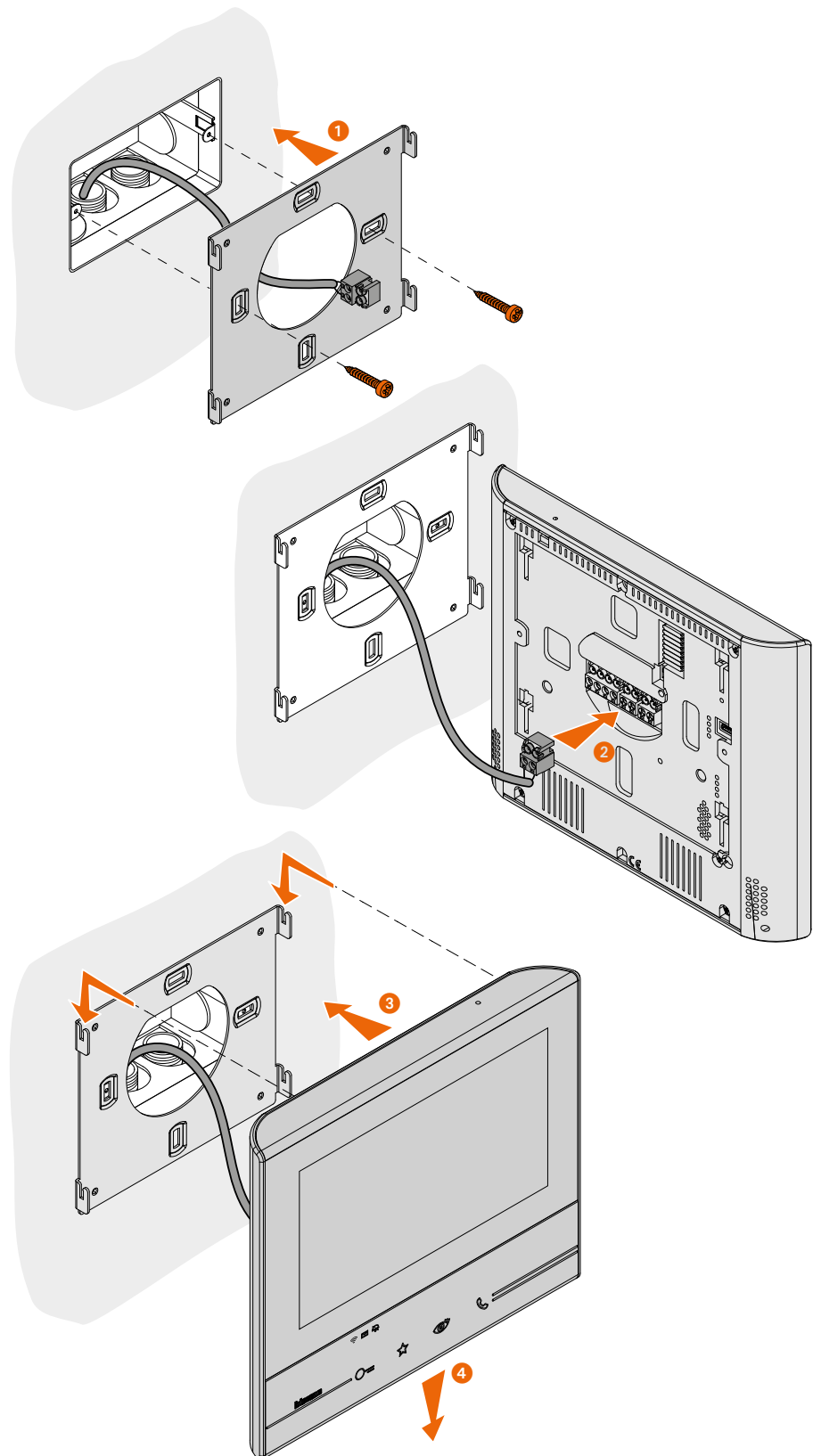

Caution: avoid fastening the bracket on uneven or irregular surfaces and excessive screw tightening, in order to prevent any bracket distortion that may compromise the correct installation of the device. The device must slide in the appropriate bracket rails with a slight pressure and without straining.

Installation on the table-top base

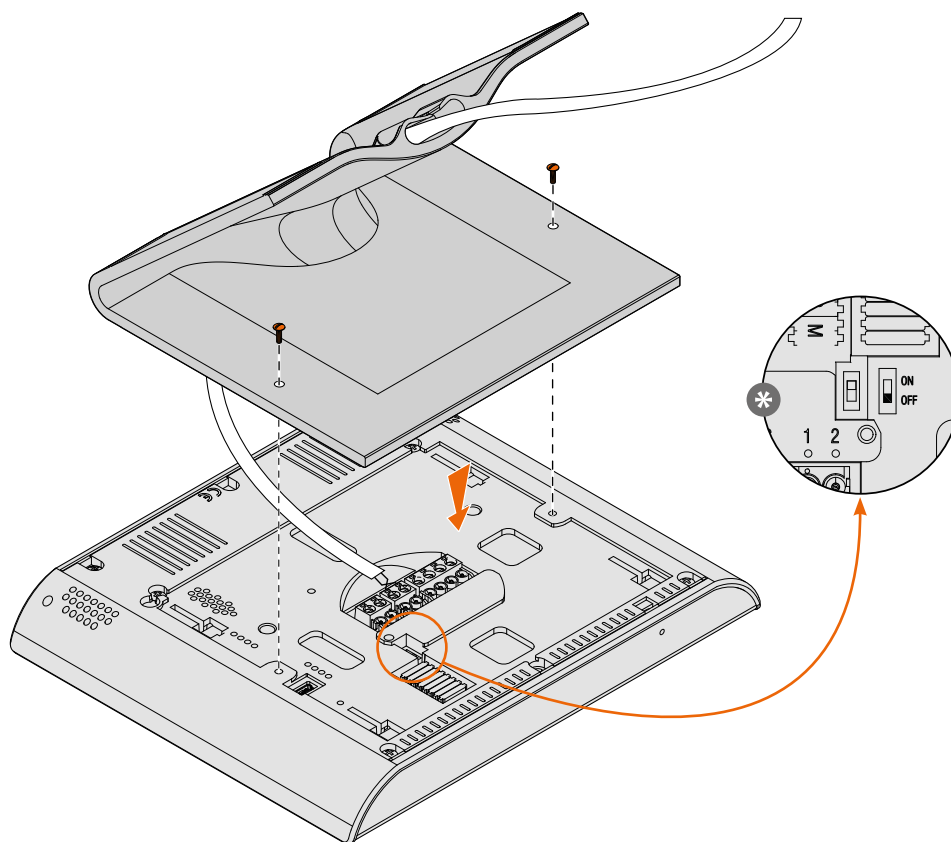

* Position the microswitch on ON to terminate the line.



8-way socket:
336982/83/84 Livinglight
349414/15/18 Axolute

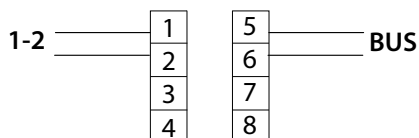
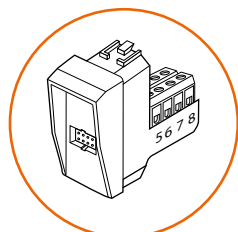

Wi-Fi installation requirements

Check the Wi-Fi signal quality from the device display (see the Installer Manual). If it is low or does not exist, make sure that:

- the device is not installed near large metal objects or electric devices that can generate electromagnetic field;
- there are fewer possible walls between the router/access point and the Classe 300X.

Note: it is recommended that the Classe 300X is installed near the Wi-Fi router.

Note: it is possible to install just one Classe 300X for each Wi-Fi (SSID) network.

Note: it is possible to install just one Classe 300X for apartment

✓¹ Suggested

* Always check the Wi-Fi signal on the device display before final installation of the objects.

📶 The device has been correctly connected to the Wi-Fi network and configured in the appropriate [section](#).

📶 The Wi-Fi signal is not sufficient to ensure the correct call transfer and other smartphone features. Check the Wi-Fi installation requirements

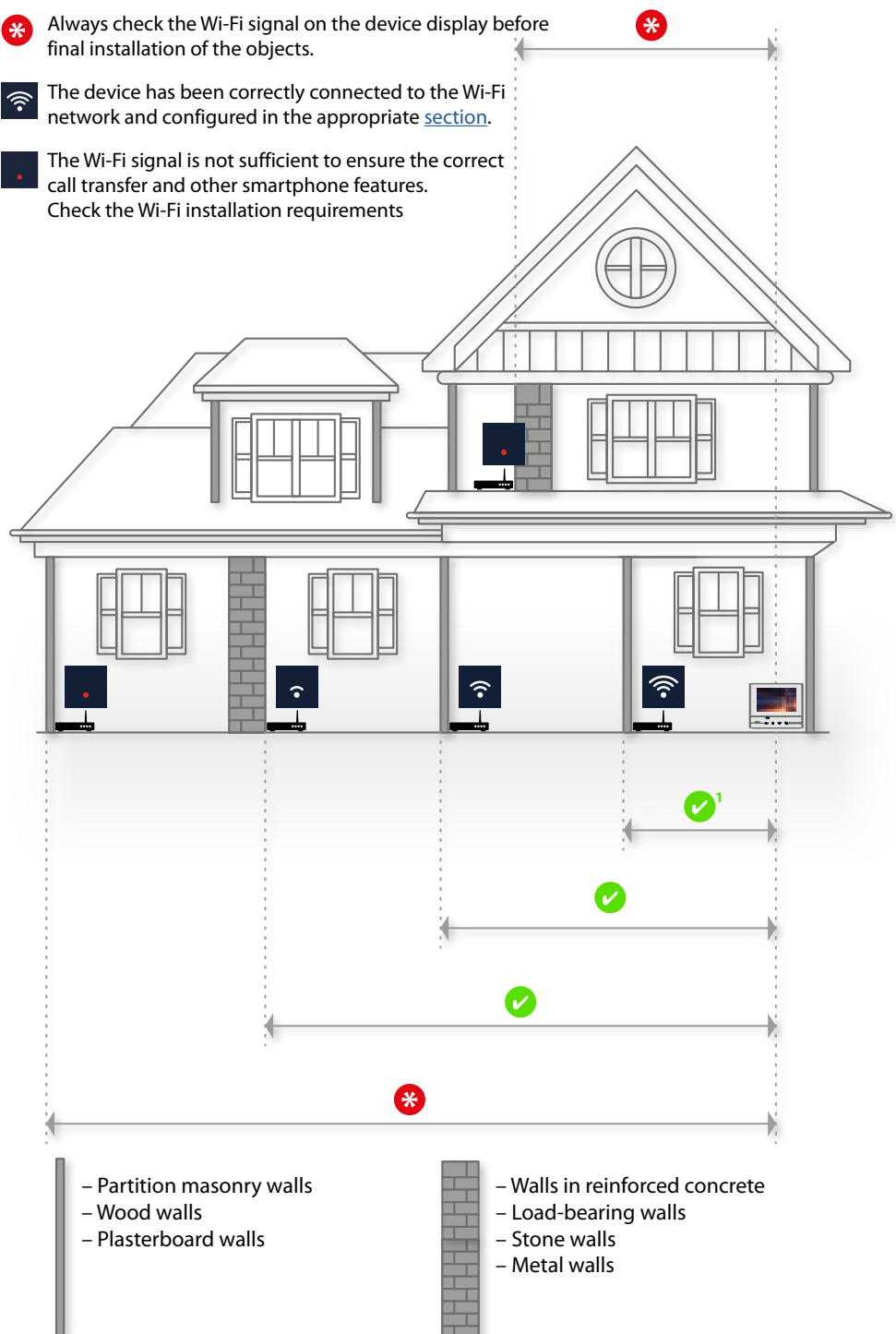

Physical configuration

The device must be configured both physically or in [advanced mode](#), the main differences are shown in the following table:

Note: the connection of the configurators to the N - P - M sockets precludes the possibility of using the advanced configuration.

The configuration must be performed with the device disconnected from the power supply. Before using it, wait for the LEDs to stop flashing.

Available Functions	Physical Configuration	Advanced Configuration
<p>FAVORITES KEY</p>	<p>Possibility of assigning various functions</p> <p>See "Functions of the M units configurator (Favorites key)"</p>	<p>Staircase Light function</p>
<p>QUICK ACTIONS</p>	<p>Preset:</p> <p>See "Functions of the M tenths configurator (Quick actions)"</p> <p>The user can rename, delete and add back, only the preset functions</p>	<p>Creating quick actions of all functions</p> <p>The user can decide the quick actions to display in the home page</p>
<p>FUNCTIONS</p> <p>Cameras</p> <p>Intercom</p> <p>Activations</p>	<p>The use of the functions is only available through quick actions in the home page</p> <p>See "Functions of the M tenths configurator (Quick actions)"</p>	<p>Dedicated icons in the home page and customisable, configurable functions</p> <p>See "Configuration"</p>

Configurators

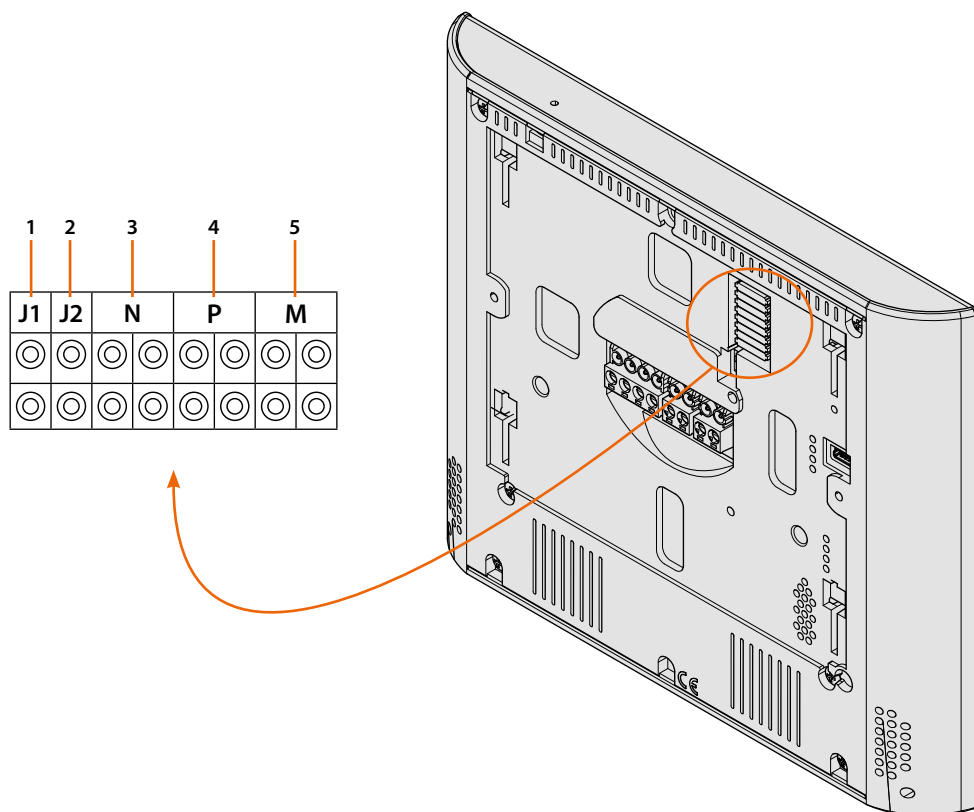

Configurator functions

1. **J1** = Remove if the additional power supply is present (clamp 1 – 2)
2. **J2** = For correct operation do not remove
3. **NN** = Device address
4. **PP** = Address of the EP of which you can open the Door Lock with IU idle, and to which you can send the auto-on command
5. **MM** = Mode of operation according to the tables on the following pages
M units = Configuration of the FAVORITES ★ capacitive key
M tenths = Configuration of the QUICK ACTIONS in the Home page

Note: If the device is configured physically, the configuration **MUST NOT BE MODIFIED** using the menu.

Functions of the M units configurator (Favorites key) ☆

J1	J2	N		P		M	
○	○	○	○	○	○	○	○
○	○	○	○	○	○	○	○



MM =	Staircase Light Control	
MM =	Direct control of P+1 Door lock	 P+1 P+1 P+1 MOD=5
MM =	Direct control of P+2 Door lock	 P+2 P+2 P+2 MOD=5
MM =	Direct control of P+3 Door lock	 P+3 P+3 P+3 MOD=5
MM =	P+1 direct auto-switching on	 P+1 P+1 MOD=9
MM =	P+2 direct auto-switching on	 P+2 P+2 MOD=9
MM =	P+3 direct auto-switching on	 P+3 P+3 MOD=9
MM =	Paging	
MM =	Internal intercom	
MM =	Enabling/disabling Professional Studio (Office) function	

Functions of the M tenths configurator (Quick actions)

The MM - (tenths) physical configurator decides which are the 4 [QUICK ACTIONS](#) icons that appear on the HOME PAGE, and can be activated by touching the display.

J1	J2	N	P	M
○	○	○	○	○
○	○	○	○	○

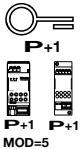
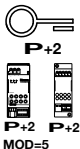
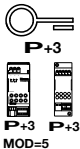
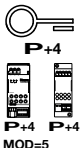
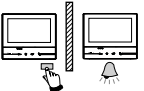
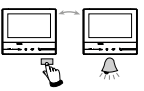
The possible configurations are shown in the following table

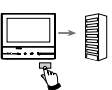
 <p>P+1 P+1 MOD=9</p>	<p>Activation of the EP (configured with P+1) directly without call or activation of the actuator item 346200/346210 (configured with P+1 and MOD=9).</p>
 <p>P+1 P+1 MOD=5</p>	<p>EP door lock release (configured with P+1), directly without call, or activation of the actuator item 346200/346210 (configured with P+1 and MOD=5), or activation of door lock actuators item 346230 (configured with P+1)</p>
 <p>P+2 P+2 MOD=5</p>	<p>EP door lock release (configured with P+2), directly without call, or activation of the actuator item 346200/346210 (configured with P+2 and MOD=5), or activation of door lock actuators item 346230 (configured with P+2)</p>
 <p>P+3 P+3 MOD=5</p>	<p>EP door lock release (configured with P+3), directly without call, or activation of the actuator item 346200/346210 (configured with P+3 and MOD=5), or activation of door lock actuators item 346230 (configured with P+3)</p>
 <p>P+4 P+4 MOD=5</p>	<p>EP door lock release (configured with P+4), directly without call, or activation of the actuator item 346200/346210 (configured with P+4 and MOD=5), or activation of door lock actuators item 346230 (configured with P+4)</p>
	<p>Intercom among apartments in systems with apartment interface item 346850.</p>
	<p>Intercom inside the apartment, in systems with apartment interface item 346850, or intercom among apartments in systems without apartment interface.</p>
	<p>Internal intercom. It sends the call to all the handsets with the same address.</p>
	<p>Paging, makes a general intercom. It sends the call to all the handsets of the system.</p>

<table border="1"> <tr><td>P</td><td>M</td></tr> <tr><td>0</td><td>1</td></tr> <tr><td>○</td><td>○</td></tr> </table>	P	M	0	1	○	○	<table border="1"> <tr><td>P</td><td>M</td></tr> <tr><td>0</td><td>2</td></tr> <tr><td>○</td><td>○</td></tr> </table>	P	M	0	2	○	○	<table border="1"> <tr><td>P</td><td>M</td></tr> <tr><td>0</td><td>3</td></tr> <tr><td>○</td><td>○</td></tr> </table>	P	M	0	3	○	○
P	M																			
0	1																			
○	○																			
P	M																			
0	2																			
○	○																			
P	M																			
0	3																			
○	○																			

<table border="1"> <tr><td>P</td><td>M</td></tr> <tr><td>0</td><td>4</td></tr> <tr><td>0</td><td>0</td></tr> <tr><td>0</td><td>0</td></tr> </table>	P	M	0	4	0	0	0	0	<table border="1"> <tr><td>P</td><td>M</td></tr> <tr><td>0</td><td>5</td></tr> <tr><td>0</td><td>0</td></tr> <tr><td>0</td><td>0</td></tr> </table>	P	M	0	5	0	0	0	0	<table border="1"> <tr><td>P</td><td>M</td></tr> <tr><td>0</td><td>6</td></tr> <tr><td>0</td><td>0</td></tr> <tr><td>0</td><td>0</td></tr> </table>	P	M	0	6	0	0	0	0
P	M																									
0	4																									
0	0																									
0	0																									
P	M																									
0	5																									
0	0																									
0	0																									
P	M																									
0	6																									
0	0																									
0	0																									

<table border="1"> <tr><td>P</td><td>M</td></tr> <tr><td>0</td><td>7</td></tr> <tr><td>0</td><td>0</td></tr> </table>	P	M	0	7	0	0	<table border="1"> <tr><td>P</td><td>M</td></tr> <tr><td>0</td><td>8</td></tr> <tr><td>0</td><td>0</td></tr> </table>	P	M	0	8	0	0	<table border="1"> <tr><td>P</td><td>M</td></tr> <tr><td>0</td><td>9</td></tr> <tr><td>0</td><td>0</td></tr> </table>	P	M	0	9	0	0
P	M																			
0	7																			
0	0																			
P	M																			
0	8																			
0	0																			
P	M																			
0	9																			
0	0																			

First switching on

After the device has been configured physically and connected, it is mandatory to perform the customisations using the menu.

Wait for the LEDs to stop flashing and then touch the display to switch it on.



1. Touch the icon for the desired language.
2. Touch to continue.

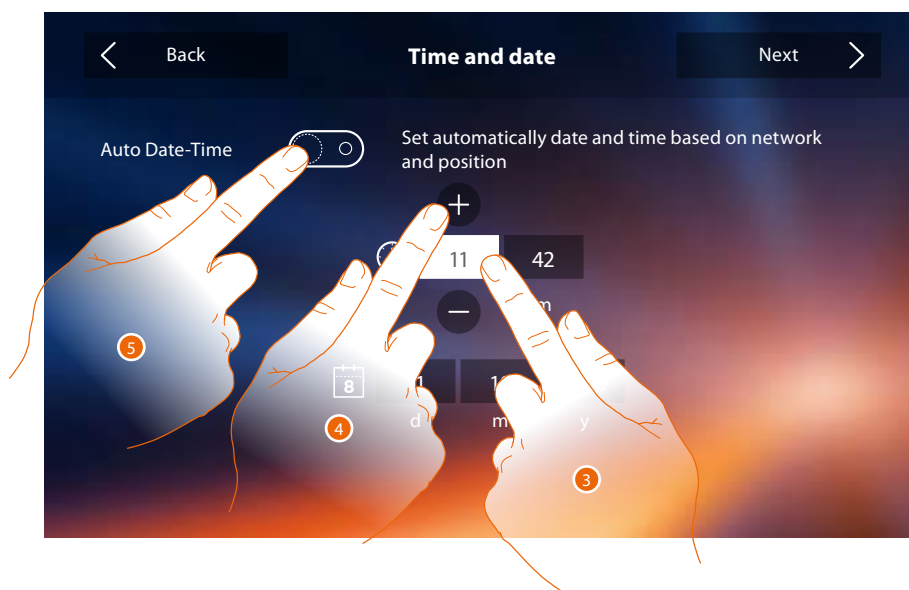

3. Touch the icon for the parameter to set (date or time); the icons to increase or decrease the value appear.
4. Touch to set it.
- Or
5. Touch to set the automatic date and time.

On enabling the function, you can set the date and time updated automatically by an NTP server. The Network Time Protocol (NTP) is a protocol to synchronise the system watches automatically, taking the correct data from the Internet

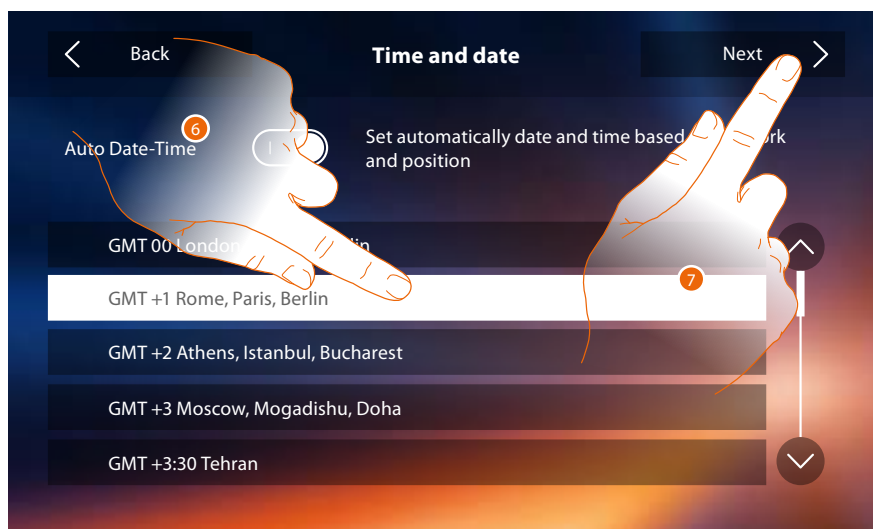

6. Touch to set the time zone.
7. Touch to continue.

Now it is possible to display information concerning the configuration of the device.

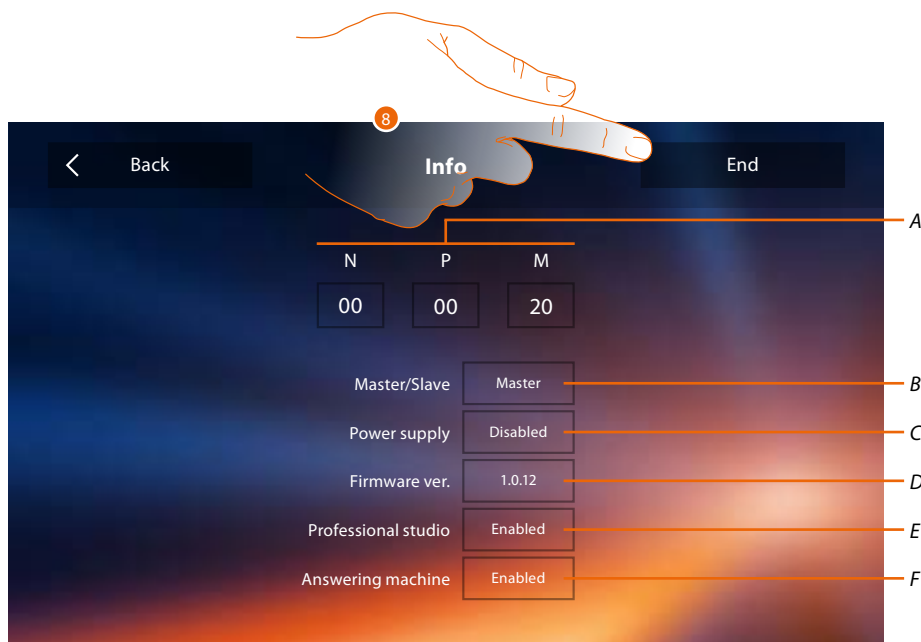

- A. Display the configuration parameters.
- B. Display if the device has been set as apartment master or slave.
- C. Display if an additional power supply is present.
- D. Display the firmware version of the device.
- E. Display if the Professional Studio function is active.
- F. Display if the Answering machine function is active.
8. Touch to end the procedure.



9. Touch to proceed with the device customisation in the [Settings](#) section.

Settings

Generals >	Wi-Fi/Associated accounts/Time and date/Language/Information/Key tone
Ringtones >	Volume/Intercom ringtone/Entrance Panel Ringtone/Other ringtones...
Display >	Clean monitor/Background/Calibration
Answering machine >	Recording Mode/Welcome Message/Record Message...
Quick Actions >	Add quick action
Configuration >	Activation of Answering machine/ Professional Studio (Office)

General settings

This section contains the general settings and device information.

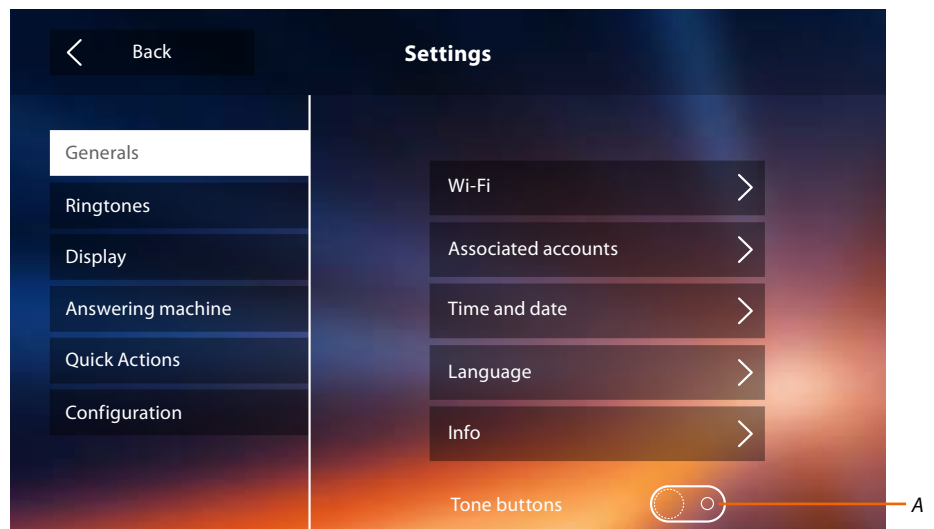

A. Enable/disable the sound when a key is pressed.

Wi-Fi

In this section it is possible to connect the device to your Wi-Fi network.

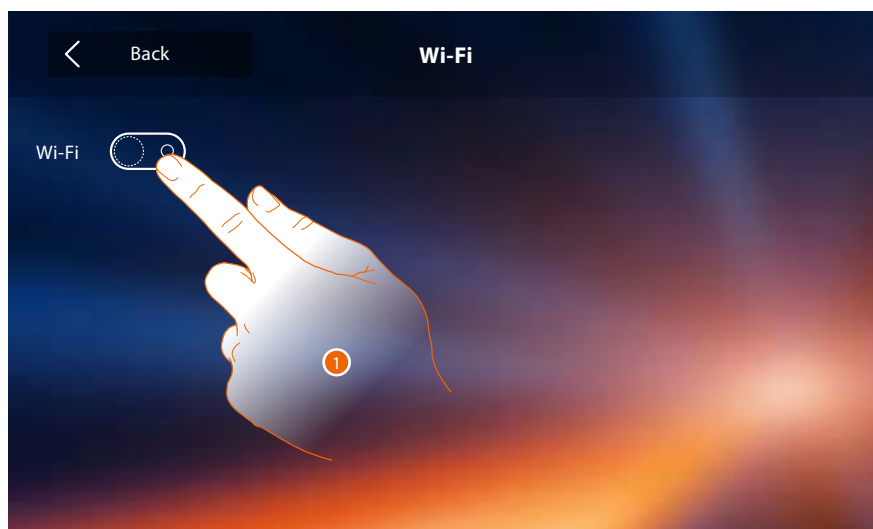

1. Touch to activate the function.

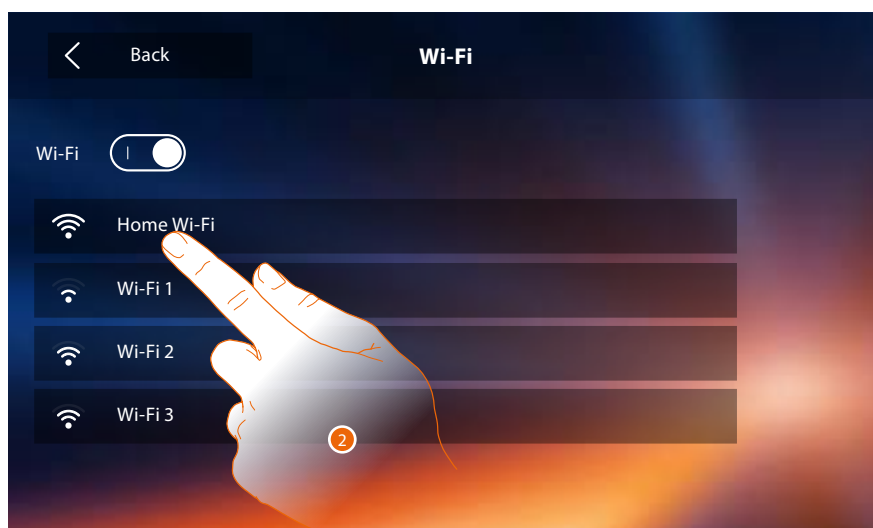

2. Select the domestic network to which you want to connect the device.

Note: your domestic network must have the following features:

- IEEE 802.11 b/g/n (2,4 GHz) 13 channels
- Encrypting and authentication methods supported:
 - OPEN WPA-PSK networks
 - TKIP WPA2-PSK included
- included AES WEP 64 bits (ASCII 5 figure or hexadecimal 10 figure codes)
- WEP 128 bits (ASCII 13 figure or hexadecimal 26 figure codes)
- WPS authentication (supported for WPA2-PSK)

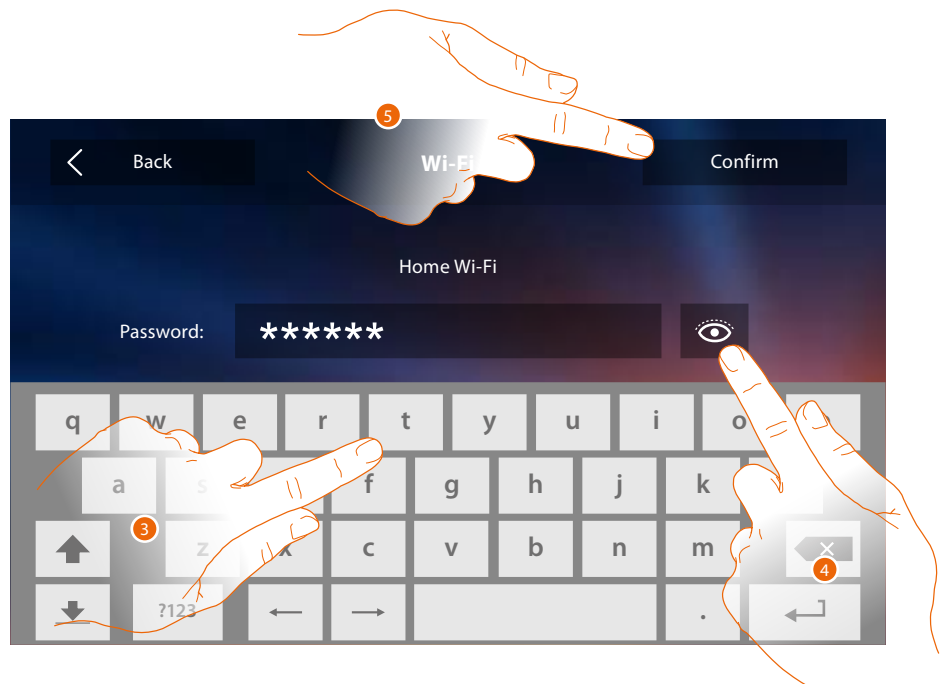

3. Enter the password (if required).
4. Touch to display the unencrypted password.
5. Touch to activate the connection.

The device provides the display or modification of the network connection parameters

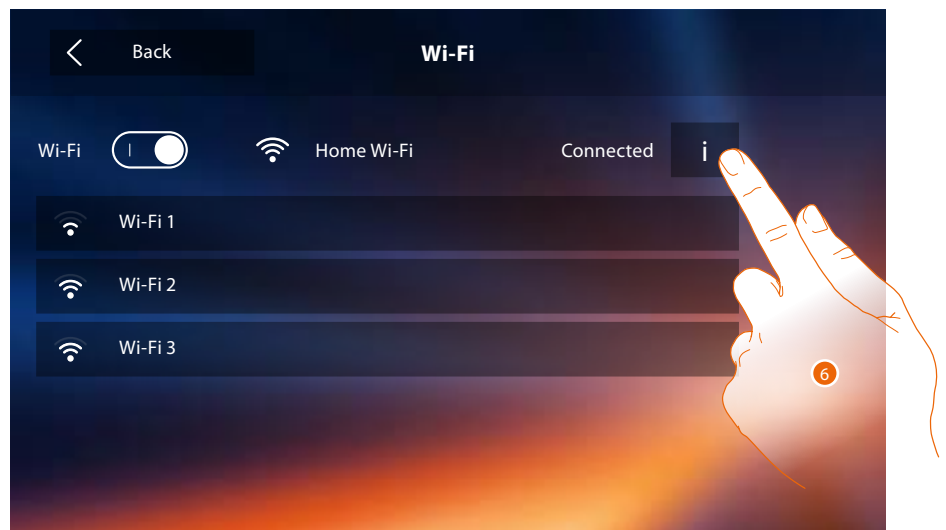

6. Touch to display or modify the network connection parameters.



7. Touch to disable the DHCP mode and to manually modify the parameters.
 - **IP address and Subnet mask:** typical parameters of TCP/IP protocol networks, necessary for the identification of the device within the local network.
 - **Gateway:** IP address of the router/access point.

***Note:** before changing the default values, contact the network administrator.
In addition to preventing the service from becoming active, wrong values can cause malfunctioning during the communication of other network devices.*

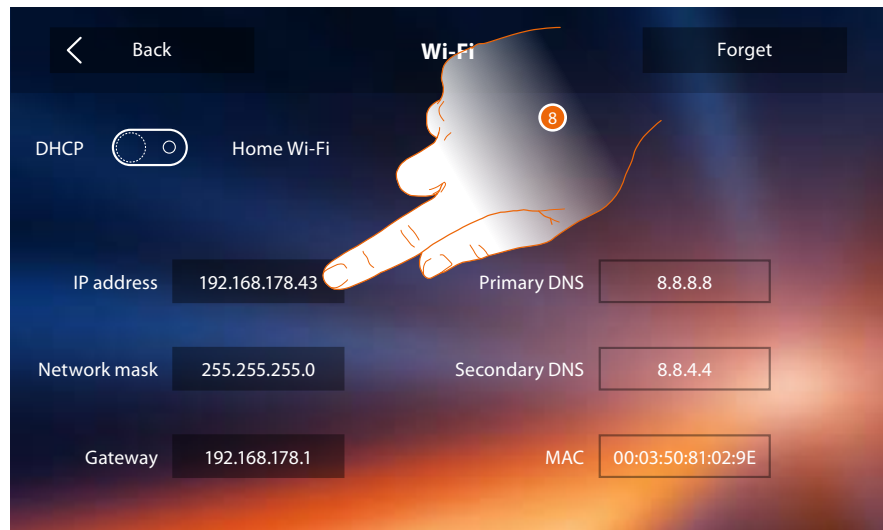

8. Touch to modify the device IP address.

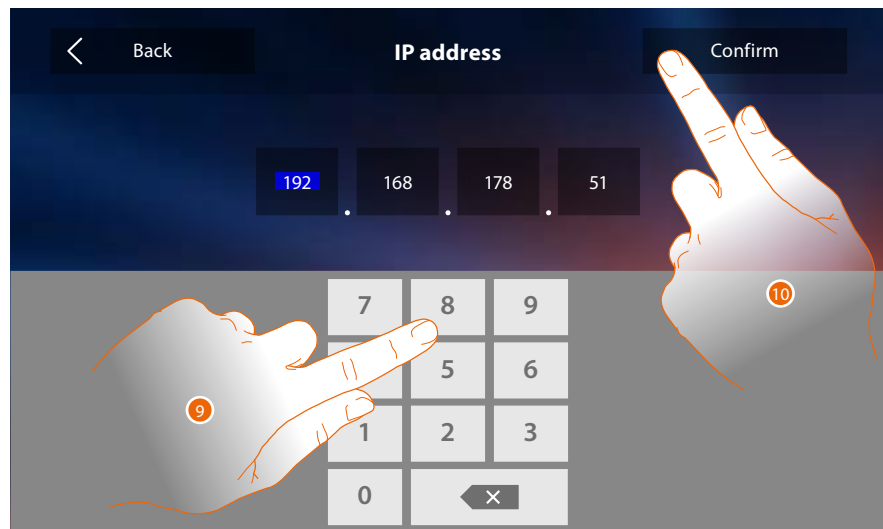

9. Enter the new IP address.

10. Touch to save it.

Associated accounts

In this section it is possible to display the list of the users associated to your Classe 300X and the smartphones connected.

It is also possible to disconnect the single smartphones or dissociate the user.

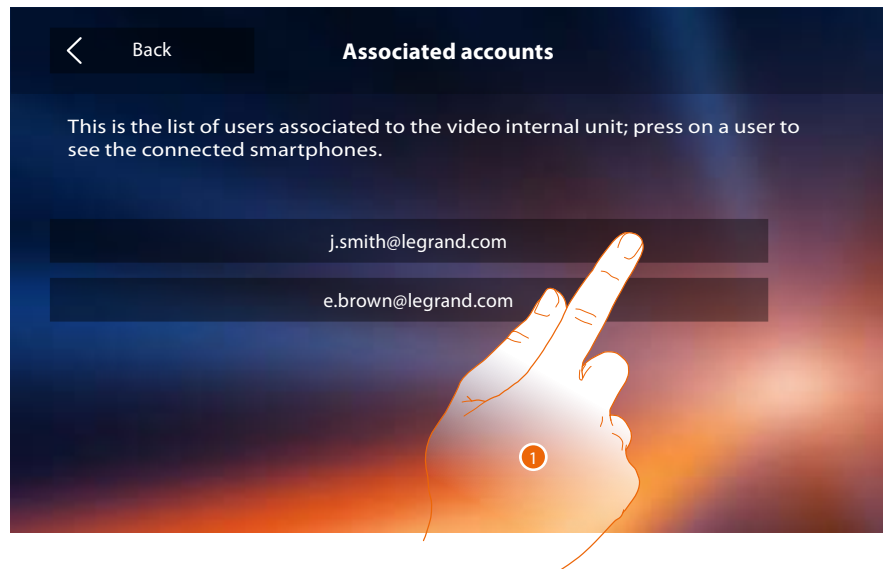

1. Touch to manage the user.

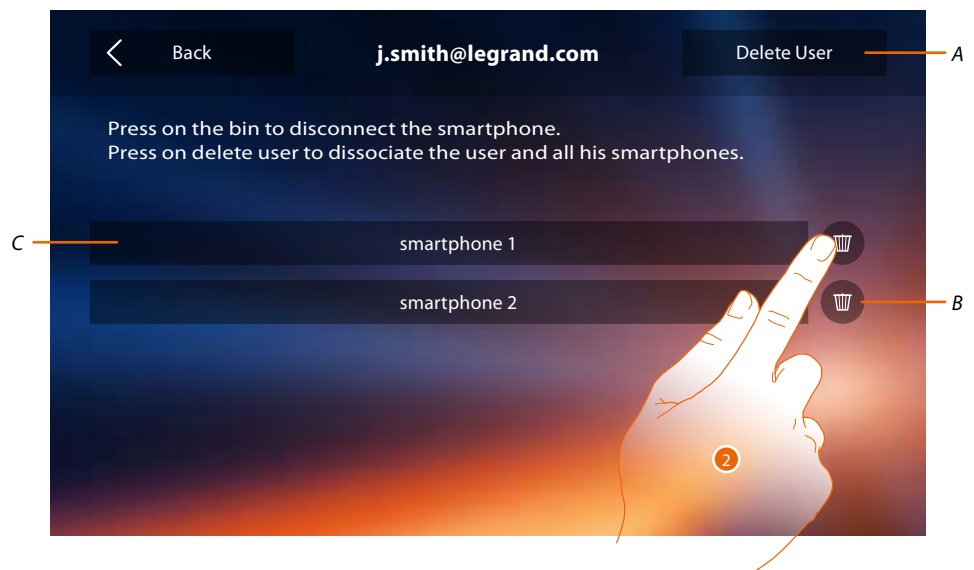

- A. Dissociate the user.
 - B. Disconnect the smartphones.
 - C. Connected smartphones.
2. Touch to disconnect the single smartphone.

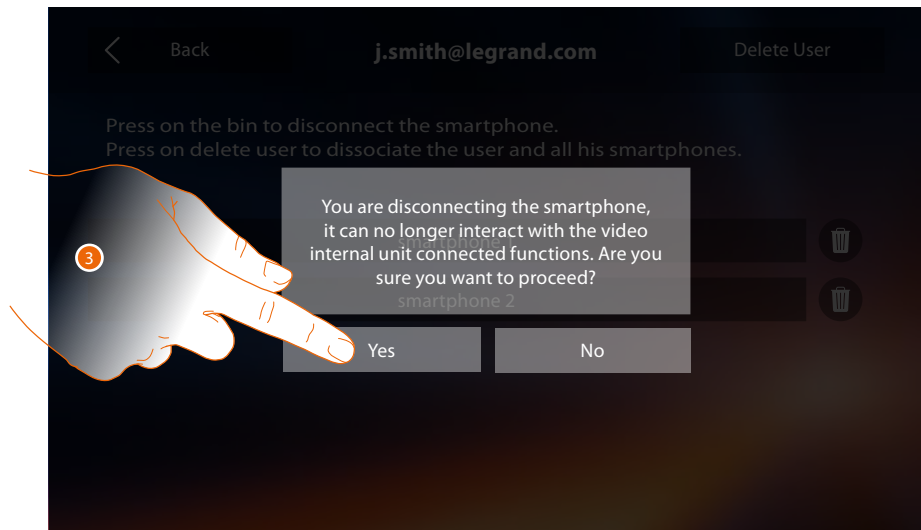

3. Touch to save it.
To connect the smartphone to the Classe 300X again, authenticate using the [DOOR ENTRY APP](#).



4. Touch to dissociate the user and consequently all the connected smartphones.

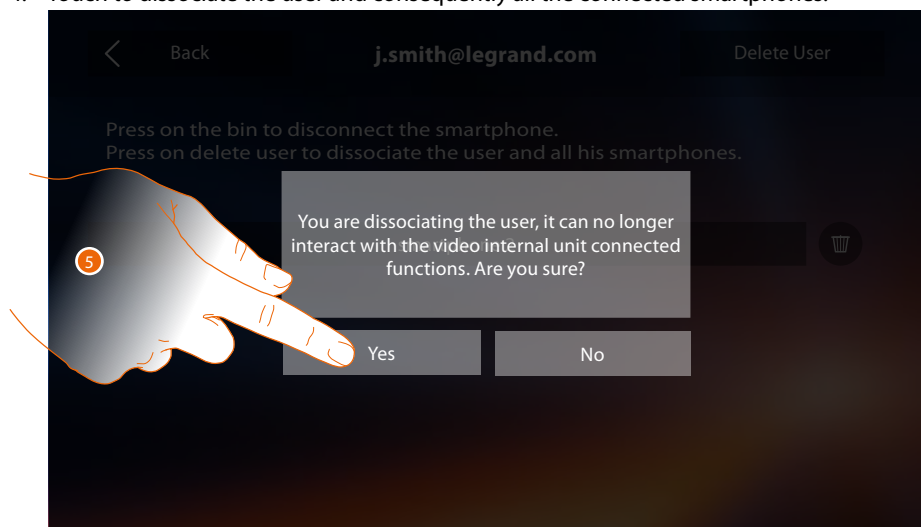

5. Touch to save it.
To associate your user again, it is necessary that another user invites you or, if there are no other users, make the association procedure again.
Note: if only one smartphone is connected to the user, when you disconnect it, you automatically disassociate the user.

Time and date

Set the current time and date.



1. Touch the icon for the parameter to set; the icons to increase or decrease the value appear.
2. Touch to set it.
3. Touch to go back and save the settings.

Or

4. Touch to set the automatic date and time.
On enabling the function, you can set the date and time updated automatically by an NTP server. The Network Time Protocol (NTP) is a protocol to synchronise the system watches automatically, taking the correct data from the Internet

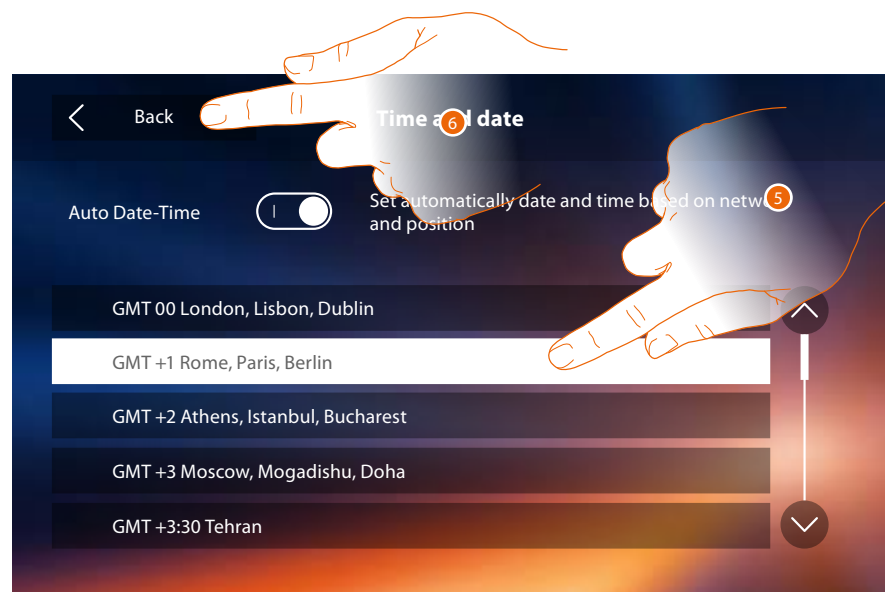

5. Touch to set the time zone.
6. Touch to go back and save the settings.

If the symbol , appears in the Home page, touch it to update the date and time.

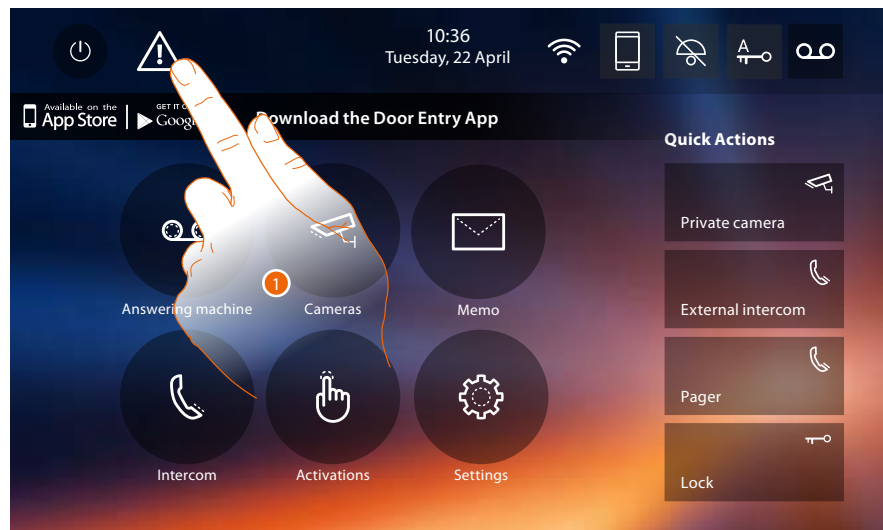

1. Touch to update the date and time.

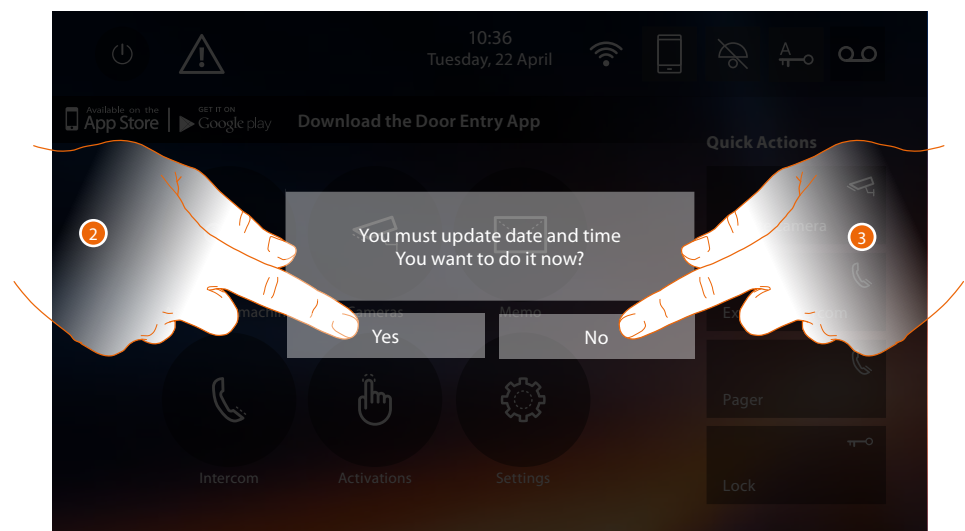

2. Touch Yes to update the time and date.

The [time and date setting page](#) appears and, once updated, after a few seconds the symbol disappears from the Home page.

Or

3. Touch NO to close the warning message; in this case the  symbol remains active in the Home page.

Information

In this section it is possible to display some information about the device configuration, the QR Code to download the user manual and the [DOOR ENTRY APP](#) and you can decide to display the APP banner in the Home Page.

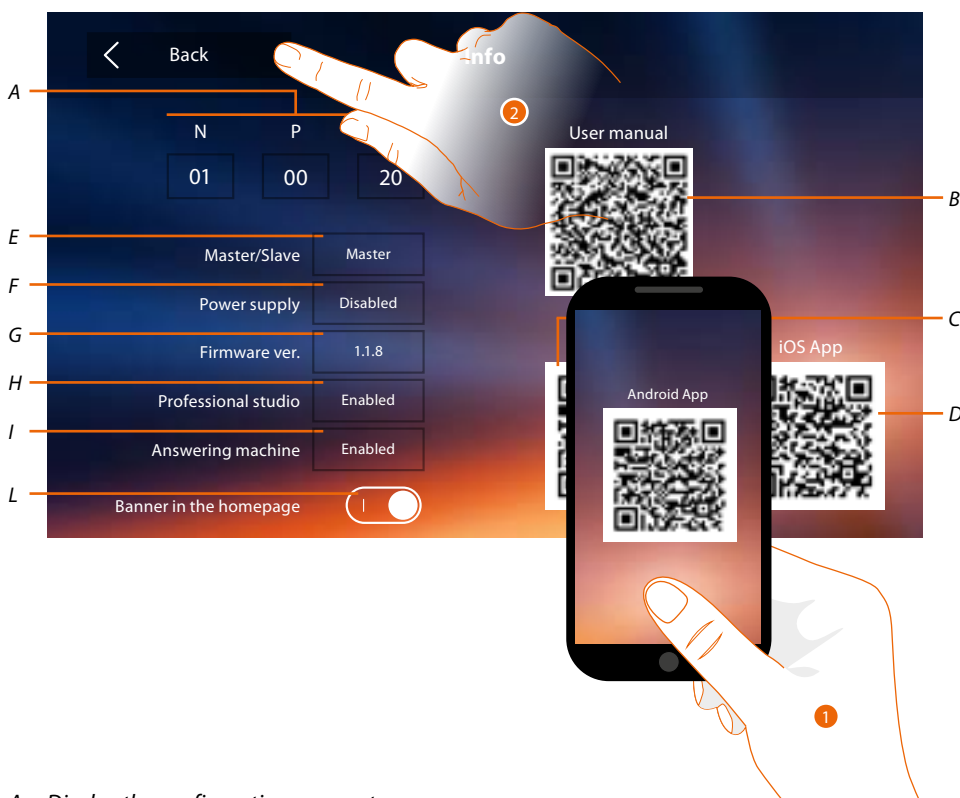

A. Display the configuration parameters.

Note: the [function](#) configurations or modification on the Classe 300X will be automatically reported also in the [DOOR ENTRY APP](#) after the first association to a smartphone and for any subsequent modification.

B. Display the QR Code to download the User Manual.

C. Display the QR Code to download the [DOOR ENTRY APP](#) (Android version).

D. Display the QR Code to download the [DOOR ENTRY APP](#) (iOS version).

E. Display if the device has been set as apartment master or slave.

F. Display if an additional power supply is present.

G. Display the firmware version of the device.

H. Display if the [Professional Studio](#) function is active.

I. Display if the [Answering machine](#) function is active.

L. Enable/disable the display in the Home Page of the banner to download the [DOOR ENTRY APP](#)

1. With a QR Code reader, read the code to install the [DOOR ENTRY APP](#) on your smartphone, that is necessary to manage the calls and other functions directly from your smartphone.

Using the [DOOR ENTRY APP](#) it is possible to:

- receive video calls from the Entrance Panels;
- manage the CCTV function;
- open the door locks of the Entrance Panels;
- call the Classe 300X;
- activate generic actuators wired on the system;
- update the Classe 300X firmware.

2. Touch to go back.

Ringtones

This section can be used to associate specific ringtones to certain events, and to adjust their volume.

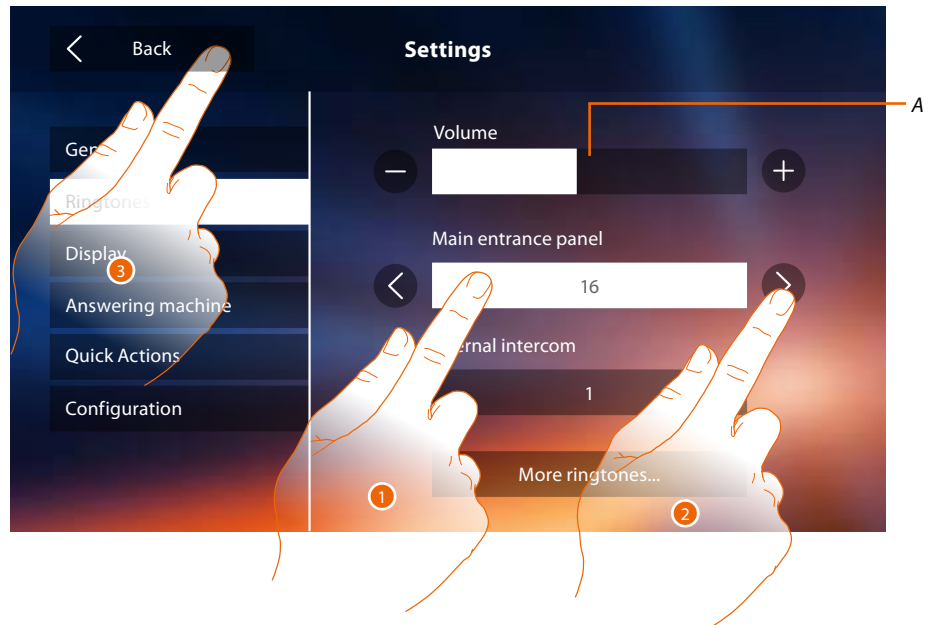

A. *Adjust the ringtone volume.*

1. Touch the event box to which to associate a specific ringtone; the selection arrows appear.
2. Scroll through the available ringtones (16); they will be played back as you scroll through them.
3. Touch to go back and save the settings.

Events to which it is possible to associate ringtones:

Main Entrance Panel: call from the main entrance panel (S0)

Internal intercom: call from an intercom in your apartment.

Other ringtones...

S1, 2, 3 Entrance Panel: call from the SECONDARY Entrance Panel (S1; S2; S3)

External intercom: call from an intercom of another apartment.

Call to the floor: call from the pushbutton outside your entrance door.

Notifications: memo from the switchboard.

Display

This section is used to calibrate, clean the monitor, and to change the background image.

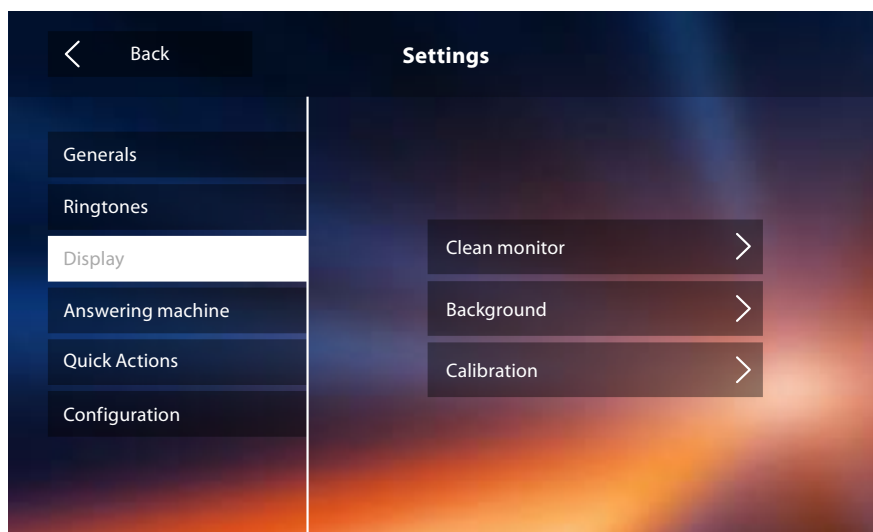

Clean monitor

It's used to disable the display and the keys for cleaning purposes, without the risk of sending unwanted commands.

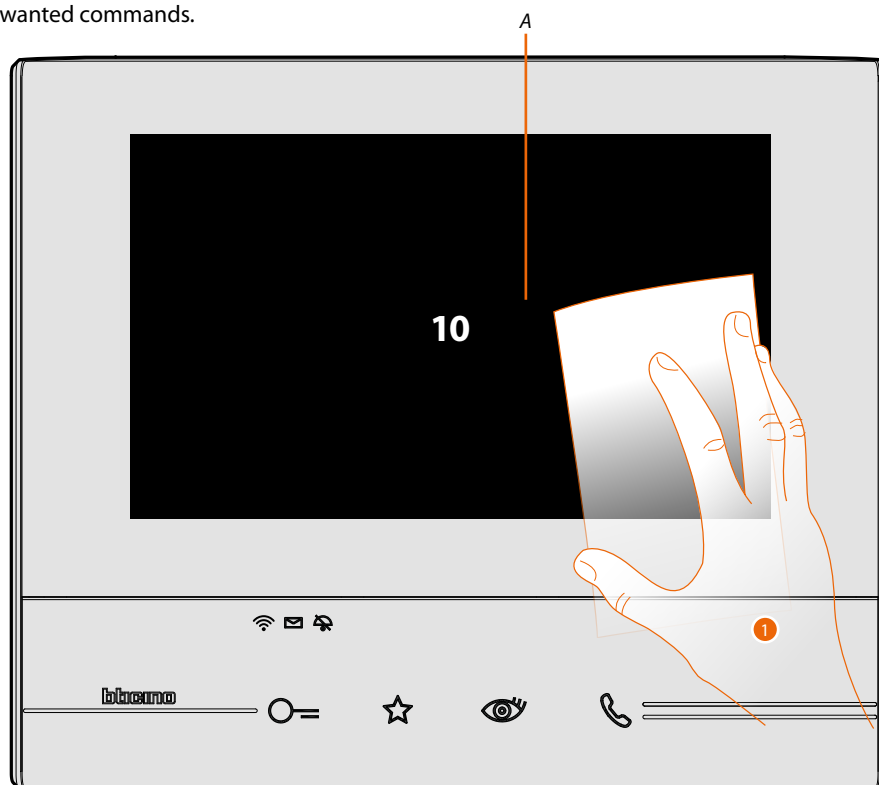

A. After touching the corresponding icon, the display remains in stand-by for 10 seconds.

1. during this period, it is possible to clean the monitor and the keys.

Note: do not clean with solvents, thinners etc. or abrasive products. Only use a soft cloth.

Background

It gives the possibility to change the background image of the device.

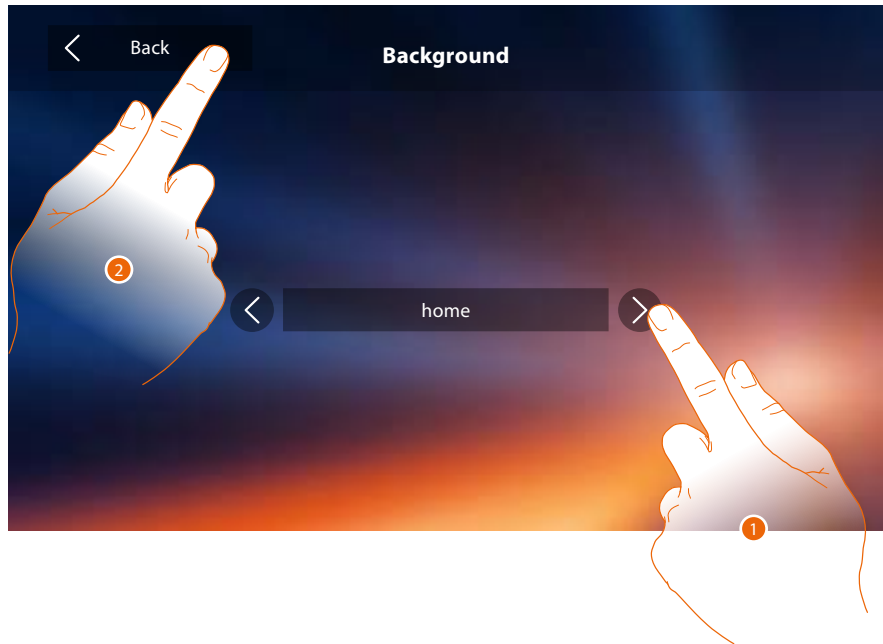

1. Scroll through the available images to get a background preview.
2. Touch to go back and save the settings.

Calibration

It can be used to adjust the touch pressure for the display.

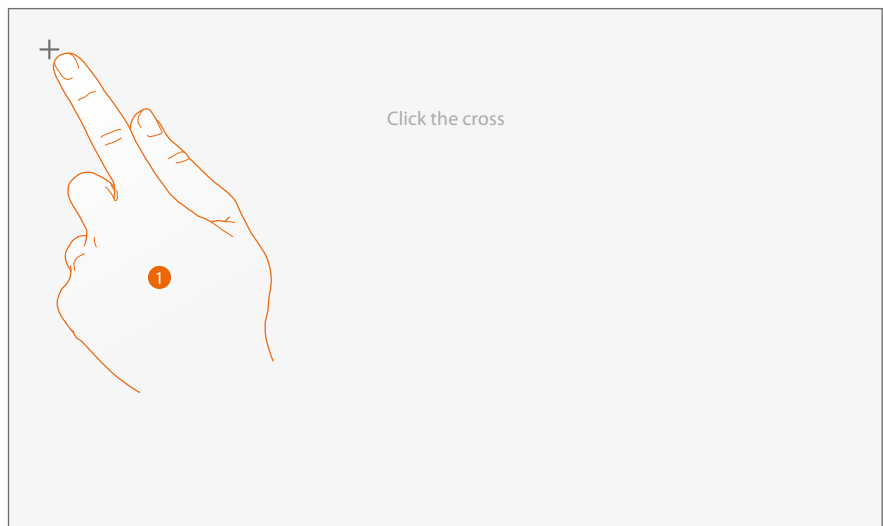

1. Touch the "cross" symbol on the display as it moves to all 5 positions. At the end, the **OK** icons appears at the corners of the display. Touch it to complete the calibration procedure.

Answering machine

This page can be used to set the quality of the videos recorded by the answering machine, or to record, enable, disable the welcome message.



A. Enable/disable the welcome message.

1. Set if video messages must be recorded in high resolution (maximum 25 x 15 sec. messages), or in low resolution (maximum 150 x 15 sec. messages)
2. Touch to record a welcome message.
3. Touch to go back and save the settings.

Note: the most recent message overwrites the oldest one.

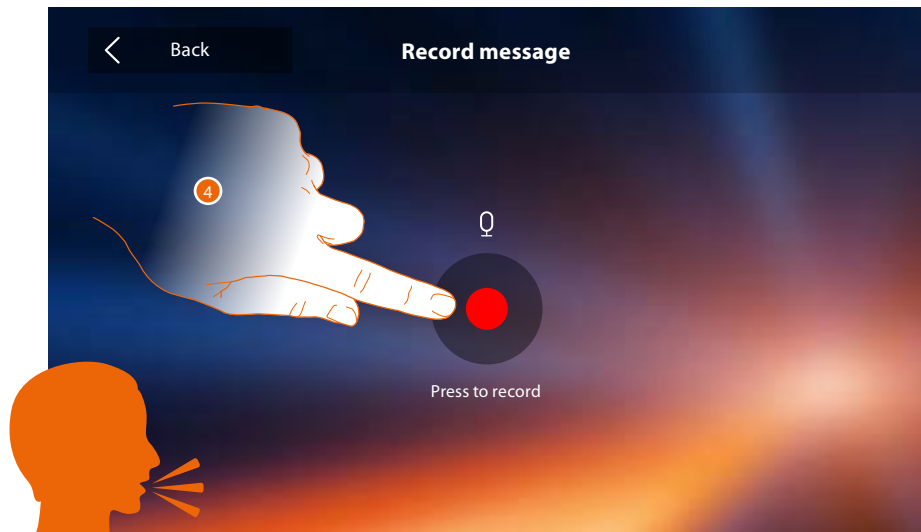

4. Touch to start recording, and then record the message.

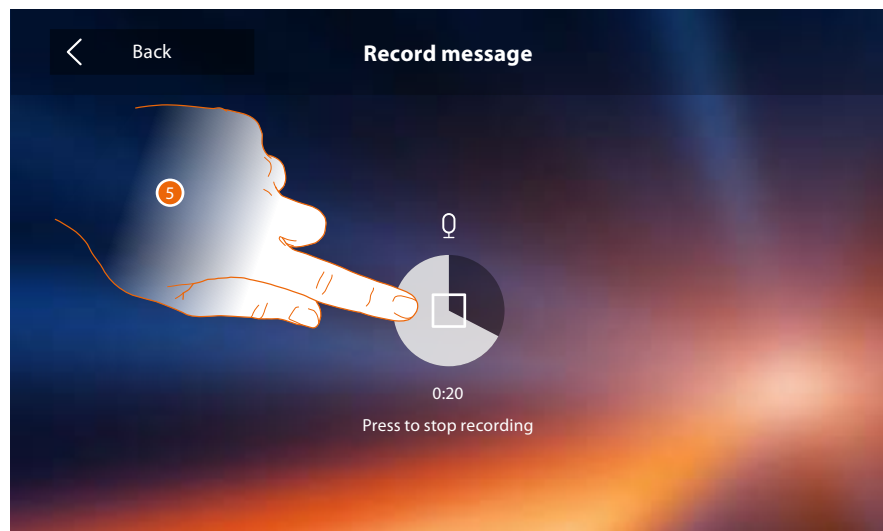

5. Touch to end the recording.

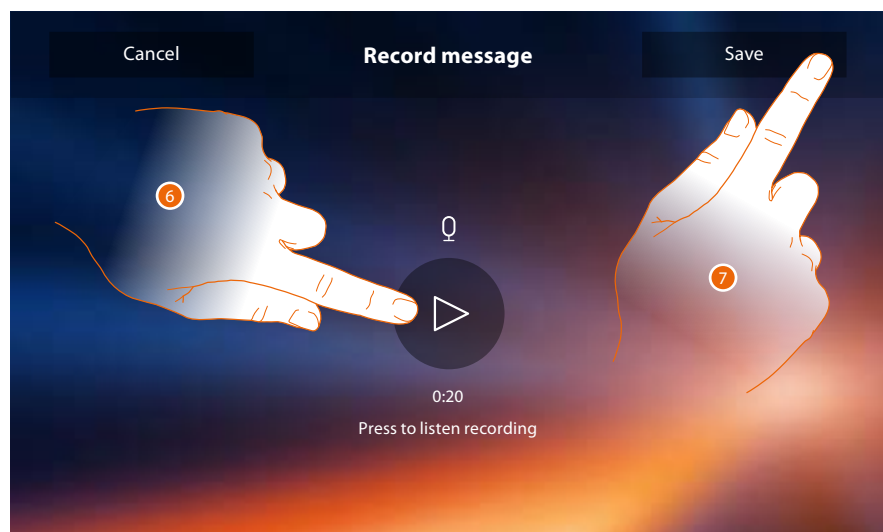

6. Touch to play the message back.
7. Touch to save it.

Quick actions

In this section it is possible to decide which actions to display in home page, selecting them among the ones available based on the configuration of socket M, tenths (See "[Functions of the M tenths configurator \(Quick Actions\)](#)").

It is also possible to customise the name

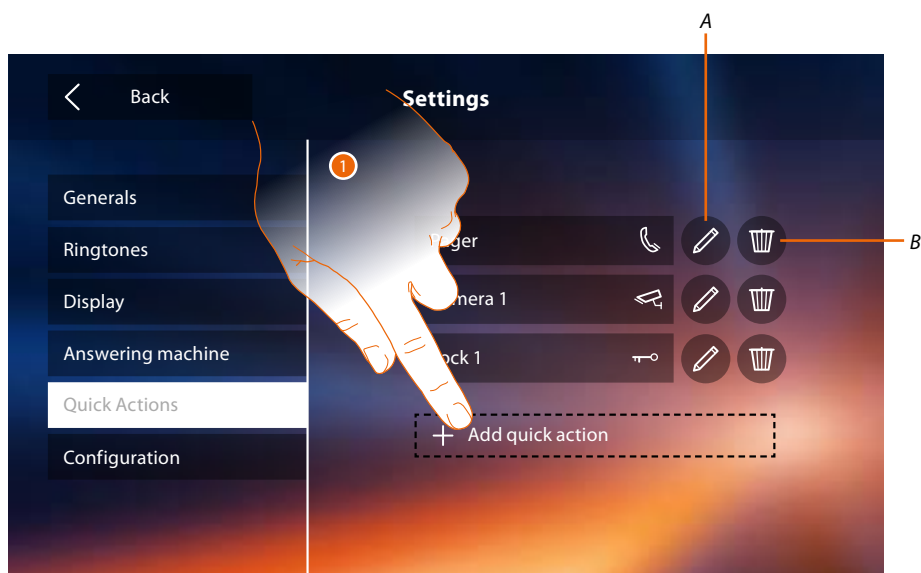

1. Touch to add a quick action.
- A. Change the name of the quick action.
- B. Remove the quick action from the home page.

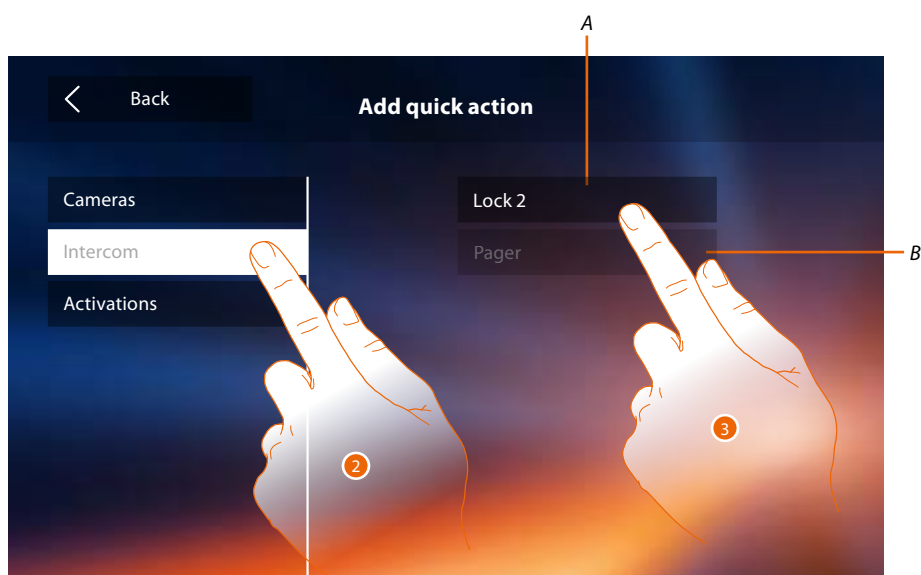

2. Select the type of function for which you want to add a quick action.
3. Select the quick action among those available.
- A. Available quick action.
- B. Quick action already included in the home page.

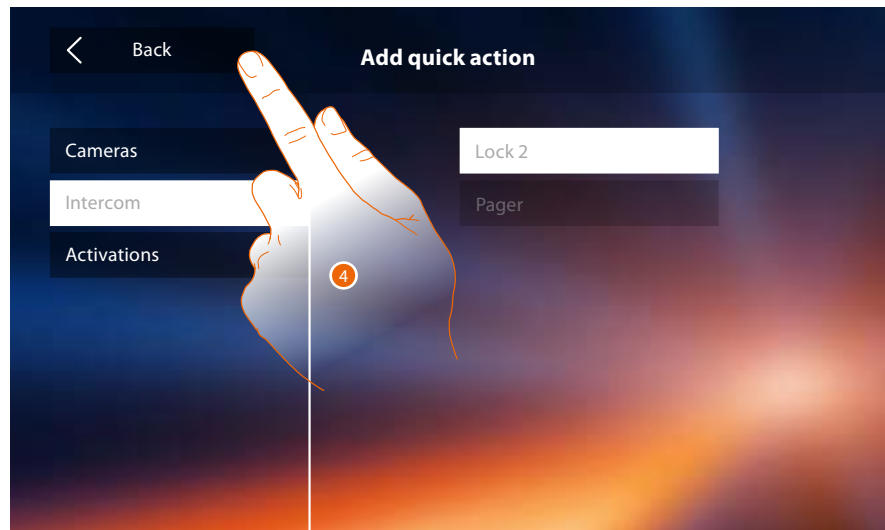

4. Touch to return to the quick action screen and save the settings.

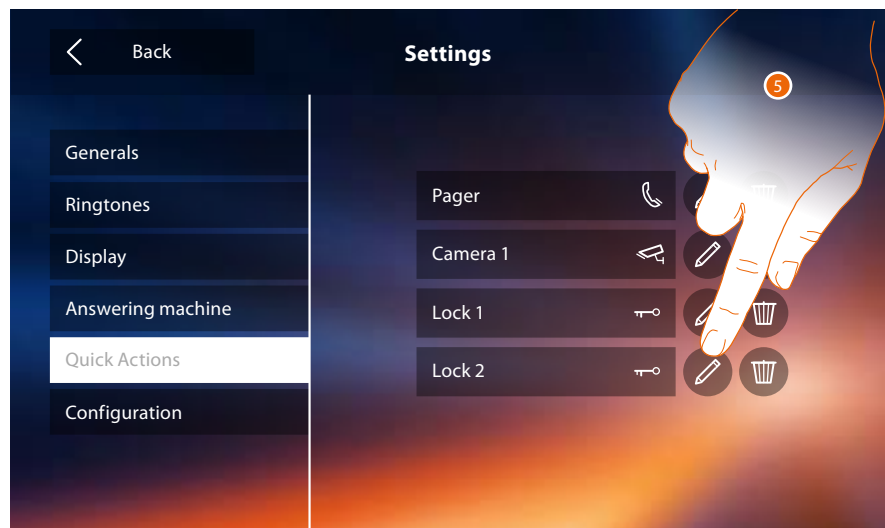

5. Touch to modify the name.

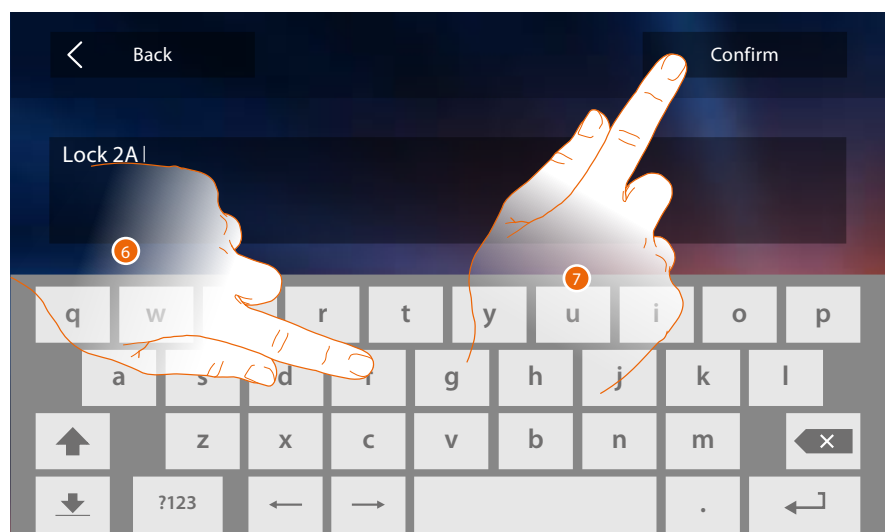

6. Enter the new name.
7. Touch to save it.

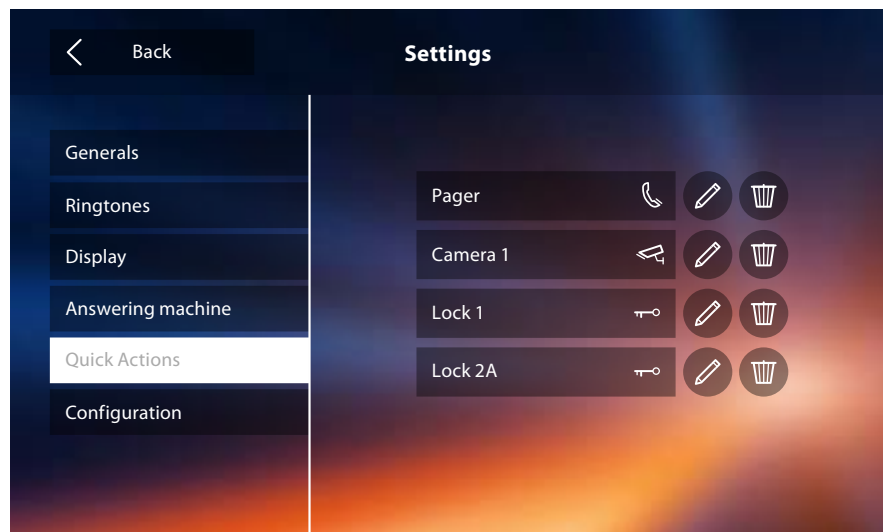

Configuration

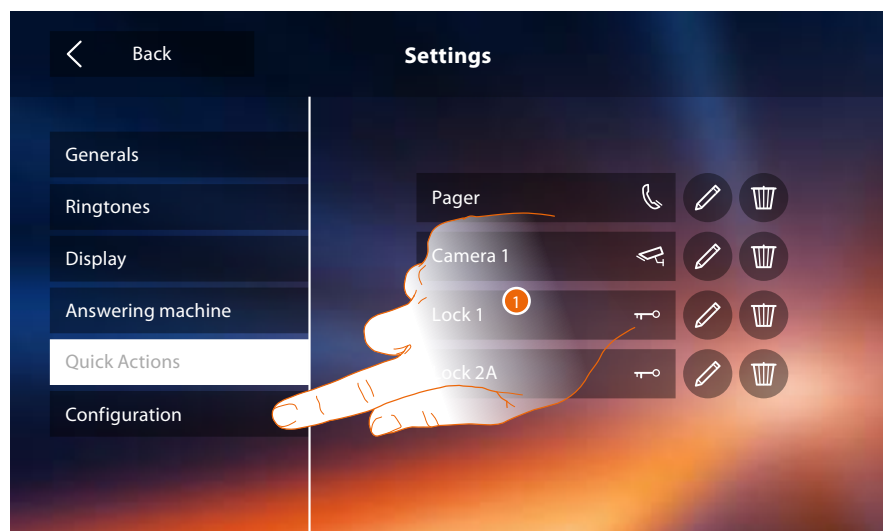

1. Touch to configure the device in advanced mode, send notifications to the after-sales service and reset the device and/or the Wi-Fi settings.

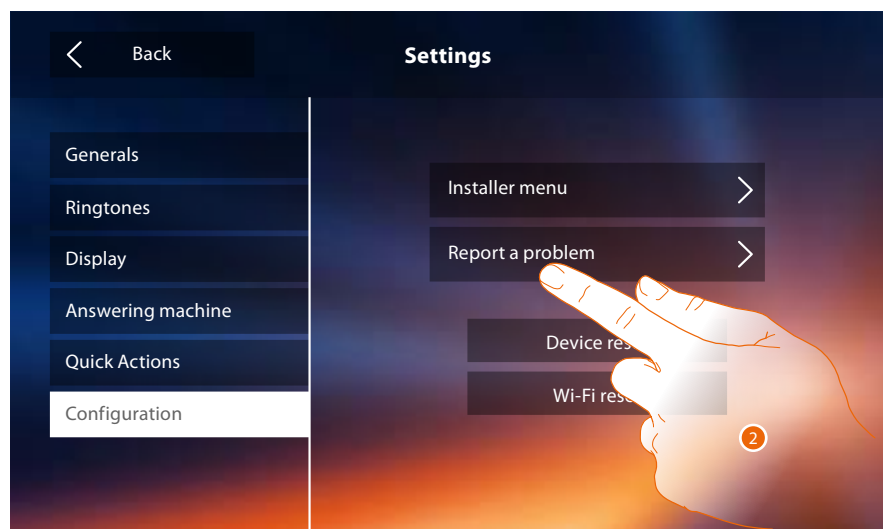

2. Touch to point out a problem which has occurred

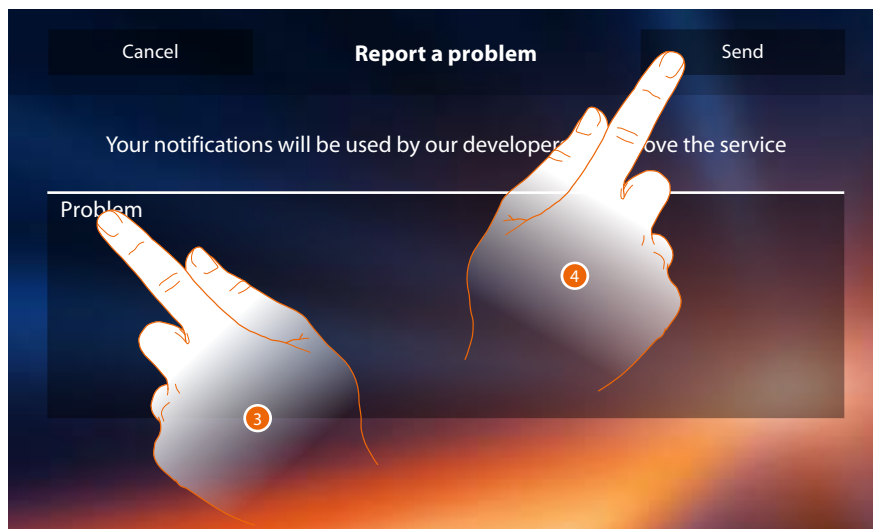

3. Describe the problem you want to point out in the correct field.
4. Touch to send the message to the after-sales service.

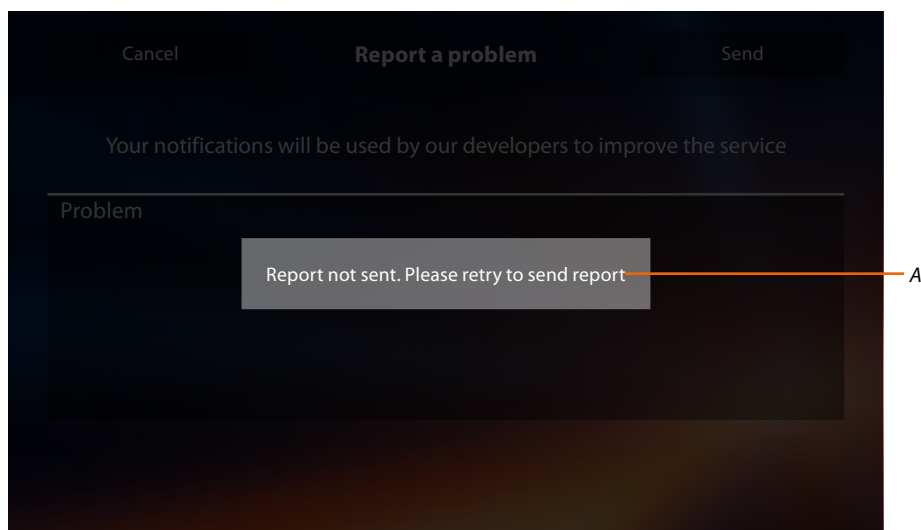

A. Display of the send notification message not successful.

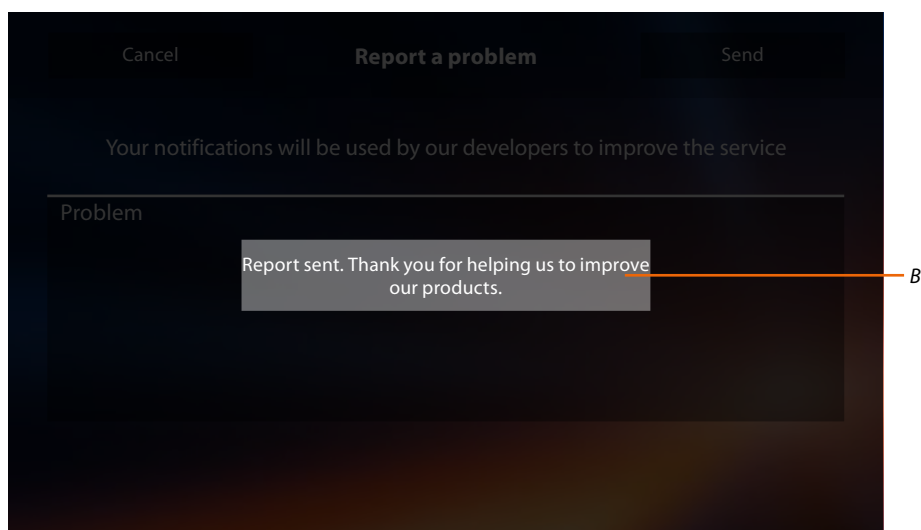

B. Display of the send notification message successful.

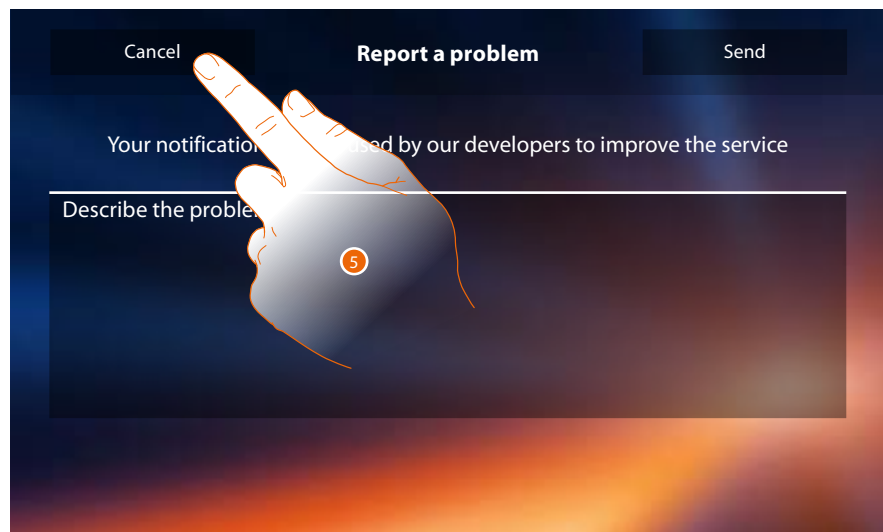

5. Touch to return to the previous page.

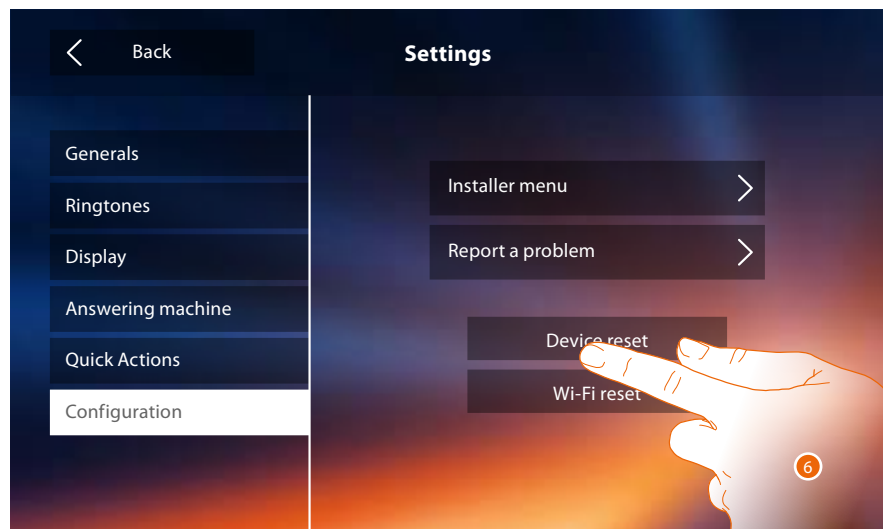

6. Touch to delete all the [associated accounts](#), the [messages in the answering machine](#), the notes.

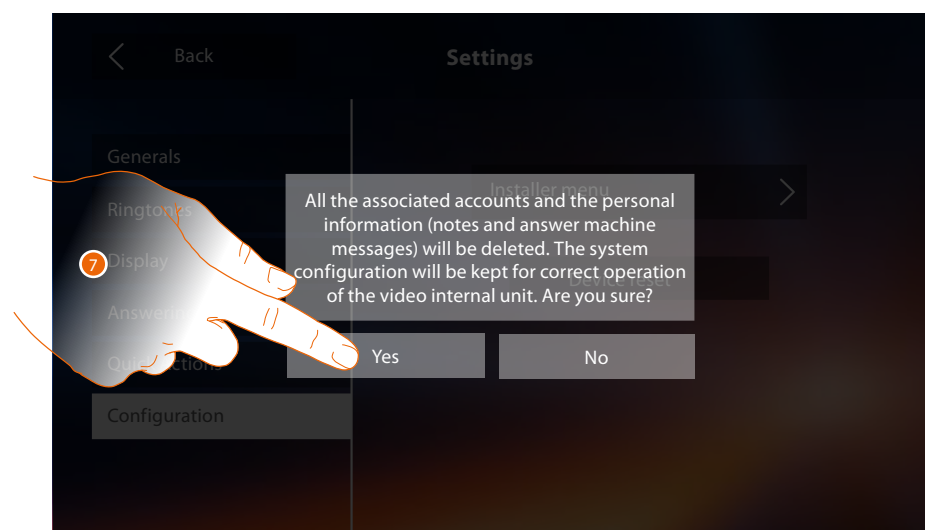

7. Touch to save it.

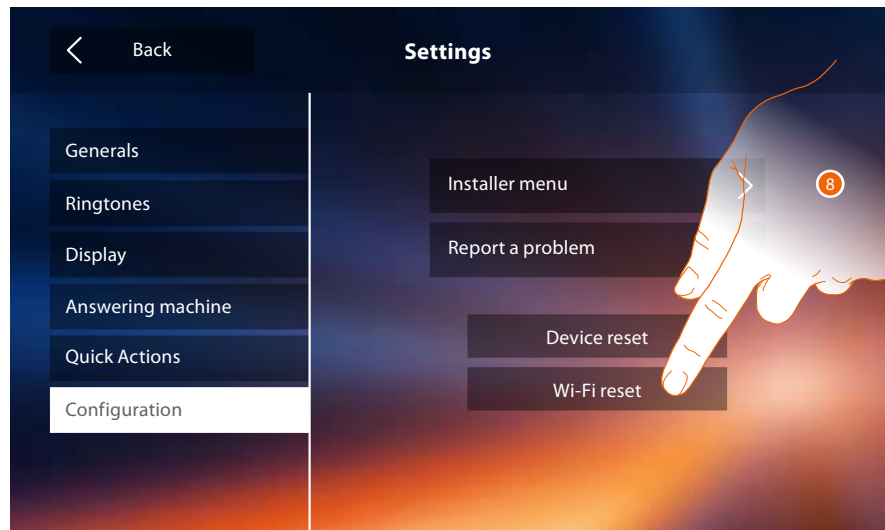

8. Touch to delete the Wi-Fi settings.

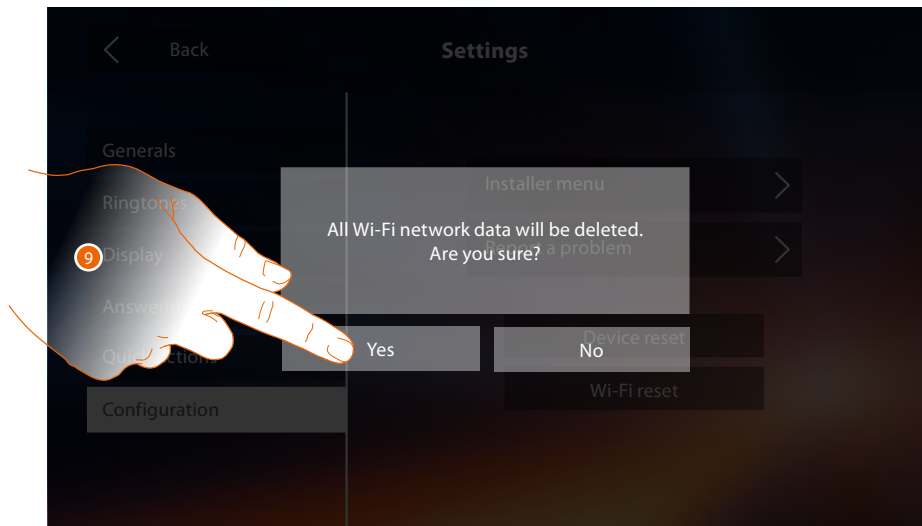

9. Touch to save it.

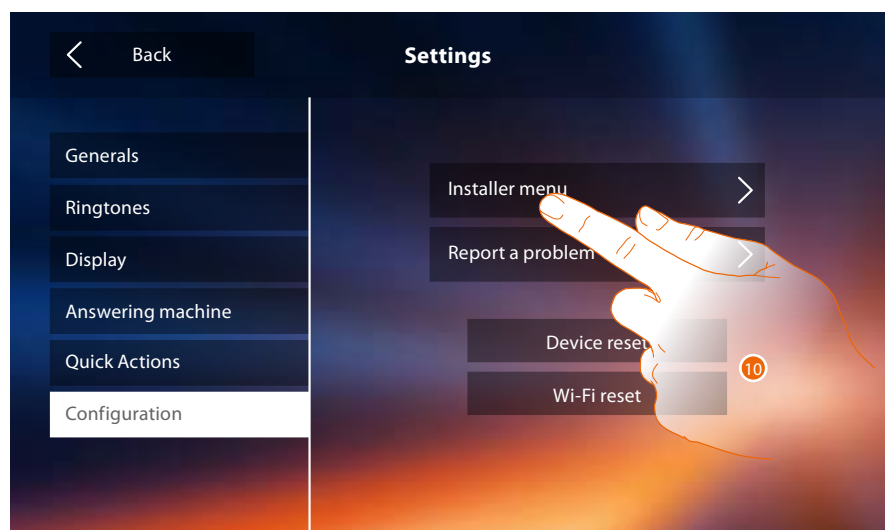

10. (After entering the unlock code) touch to make the answering machine and office functions available in the home page, therefore giving the user the possibility of enabling or disabling them.

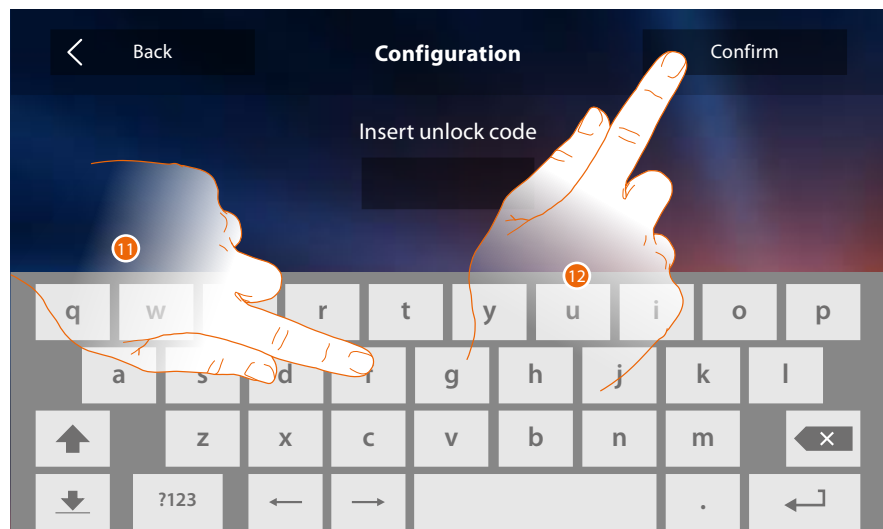

11. Touch to enter the unlock code (default 12345).
12. Touch to save it.

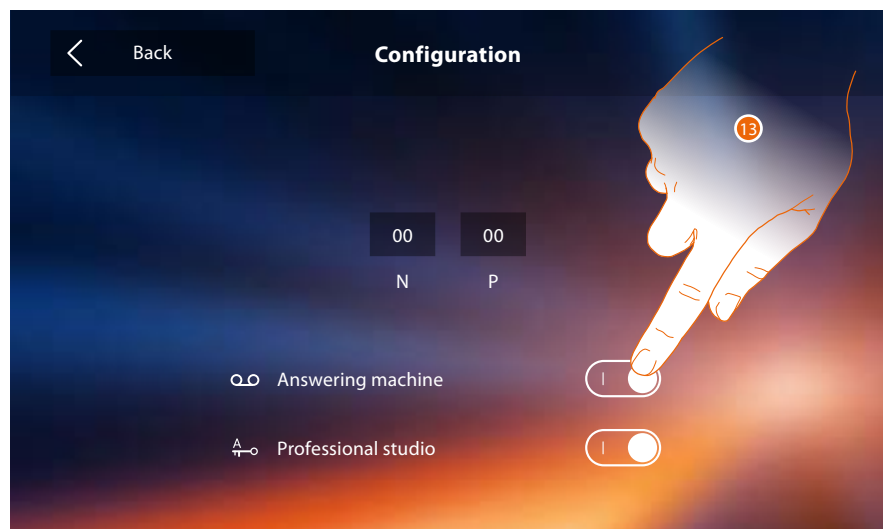

13. Touch to make the function available in the home page.

Note: Further configurations are also available in the [advanced mode](#), which can only be used if no configurators have been connected to sockets N-P-M.

Advanced Configuration

The advanced configuration gives the possibility of configuring all the basic settings, the quick actions and the camera, intercom, and activation functions, without being bound to a predefined set.

First switching on

After connecting the device, perform the customisations.

Wait for the LEDs to stop flashing and then touch the display to switch it on.



1. Touch the icon for the desired language.
2. Touch to continue.

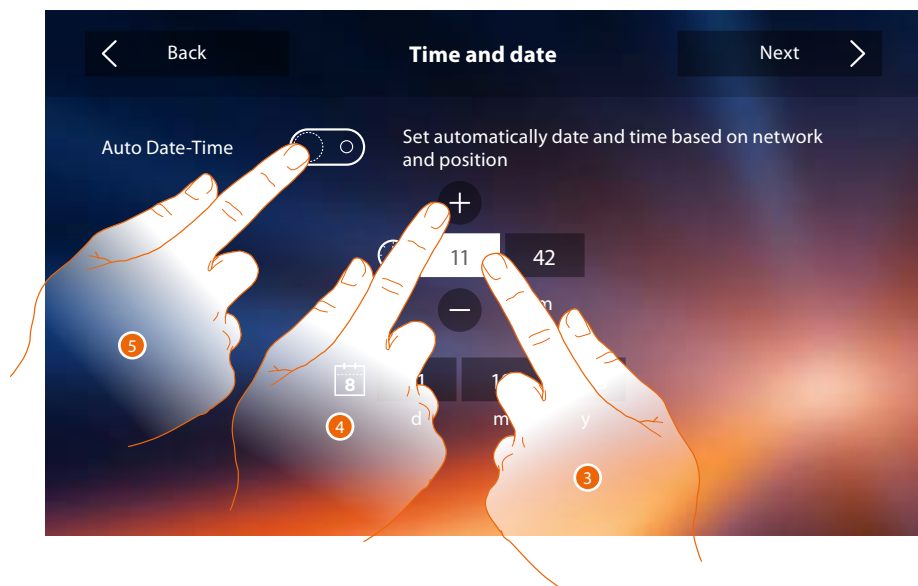

3. Touch the icon for the parameter to set (date or time); the icons to increase or decrease the value appear.
 4. Touch to set it.
- Or
5. Touch to set the automatic date and time.
On enabling the function, you can set the date and time updated automatically by an NTP server. The Network Time Protocol (NTP) is a protocol to synchronise the system watches automatically, taking the correct data from the Internet

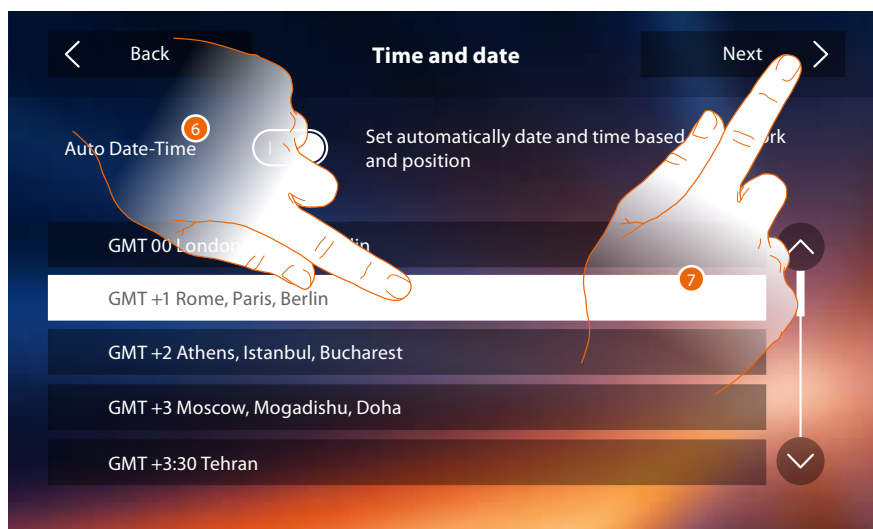

6. Touch to set the time zone.
7. Touch to continue.

Now it is possible to display some information concerning the configuration of the device

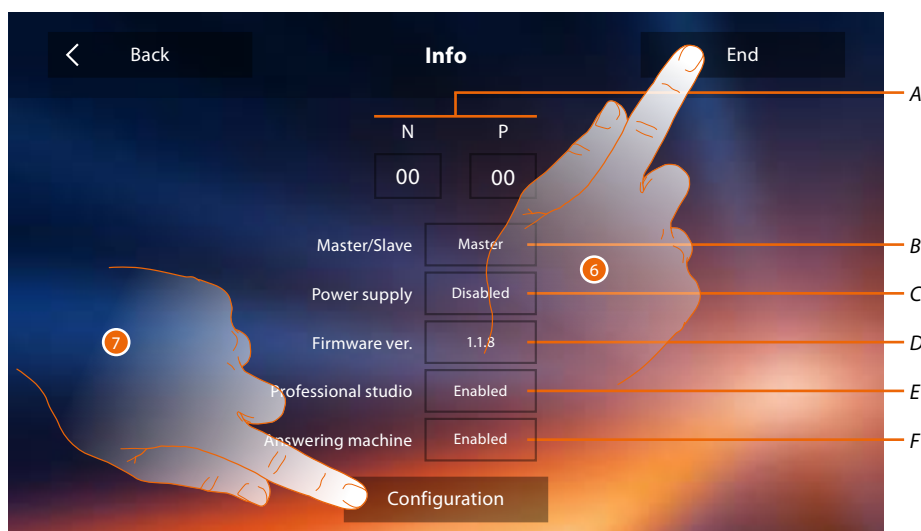

- A. Display the configuration parameters.

Note: the [function](#) configurations or modification on the Classe 300X will be automatically reported also in the [DOOR ENTRY APP](#) after the first association to a smartphone and for any subsequent modification.

- B. Display if the device has been set as apartment master or slave.
- C. Display if an additional power supply is present.
- D. Display the firmware version of the device.
- E. Display if the [Professional Studio](#) function is active.
- F. Display if the [Answering machine](#) function is active.
6. Press the End key to go to the home page, postponing the configuration to a later date.
7. Now touch to access the configuration section.



8. Enter the N configurator values to set the address device and enter the P configurator values to set the address of the EP of which you can open the Door Lock with IU idle, and to which you can send the auto-on command.

Note: the [function](#) configurations or modification on the Classe 300X will be automatically reported also in the [DOOR ENTRY APP](#) after the first association to a smartphone and for any subsequent modification.

9. Touch to make the functions available in the home page.
10. Proceed with the advanced configuration, see [configuration](#) section.

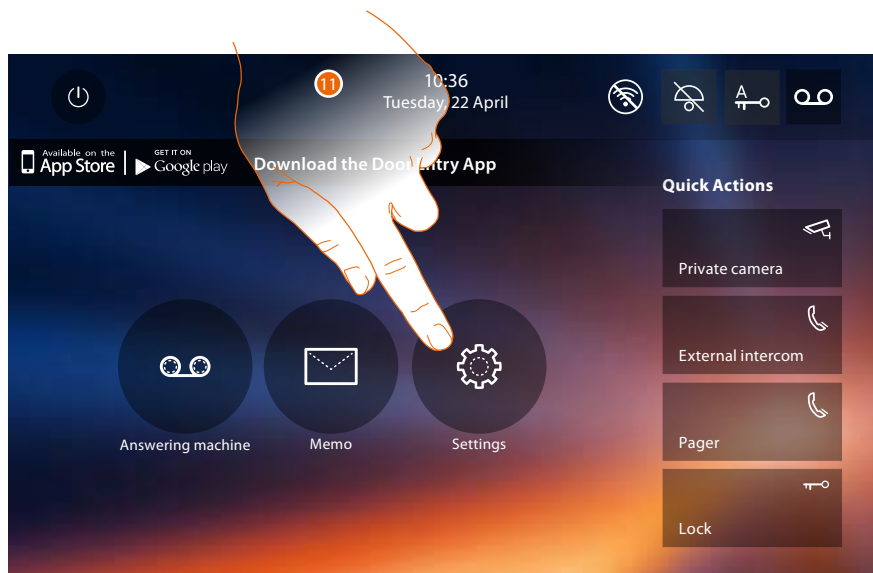

11. At the end of the configuration it is possible to customise the device in the [Settings](#) section

Settings

Generals >	Wi-Fi/Associated accounts/Time and date/Language/Information/Key tone
Ringtones >	Volume/Intercom ringtone/Entrance Panel Ringtone/Other ringtones...
Display >	Clean monitor/Background/Calibration
Answering machine >	Recording Mode/Welcome Message/Record Message...

For the above mentioned settings, refer to the [Settings](#) section of the physical configuration.

Configuration >	General/Intercom/Camera/Activation/Change password
Quick Actions >	Add quick action

Configuration

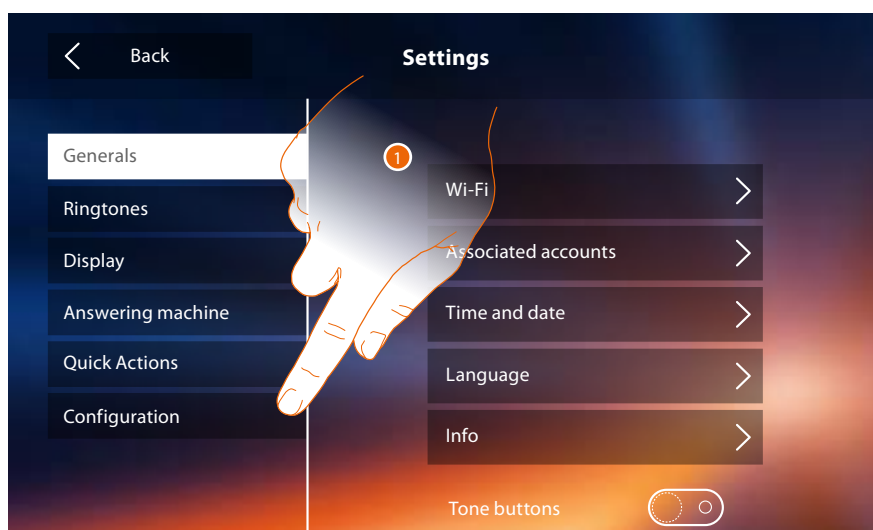

1. Touch to configure the device in advanced mode, send notifications to the after-sales service and reset the device and/or the Wi-Fi settings.

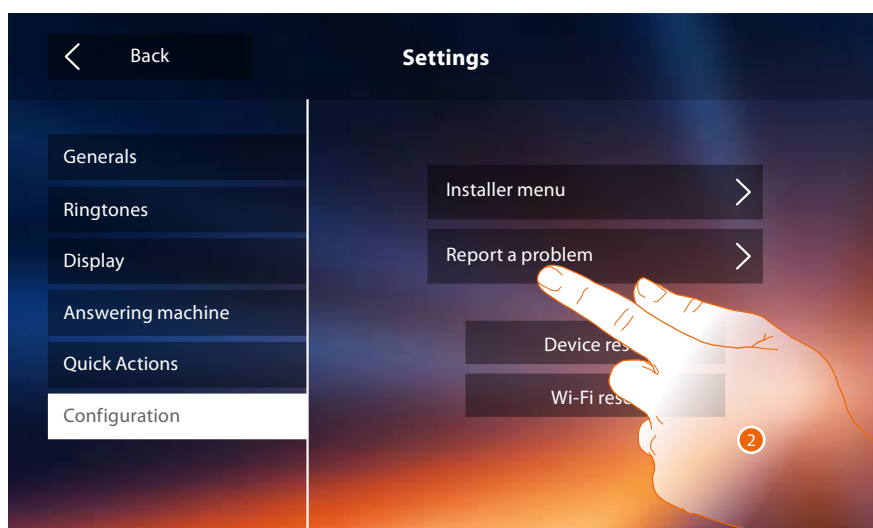

2. Touch to point out a problem which has occurred.

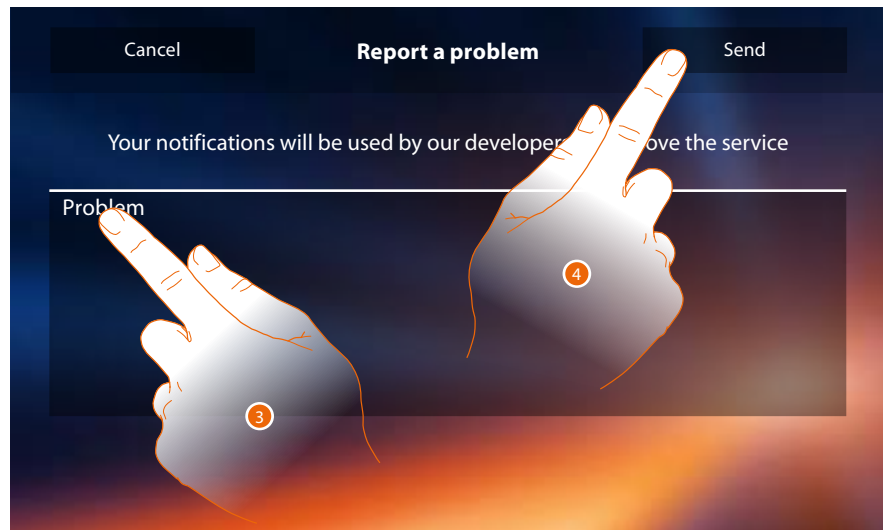

3. Describe the problem you want to point out in the correct field.
4. Touch to send the message to the after-sales service.

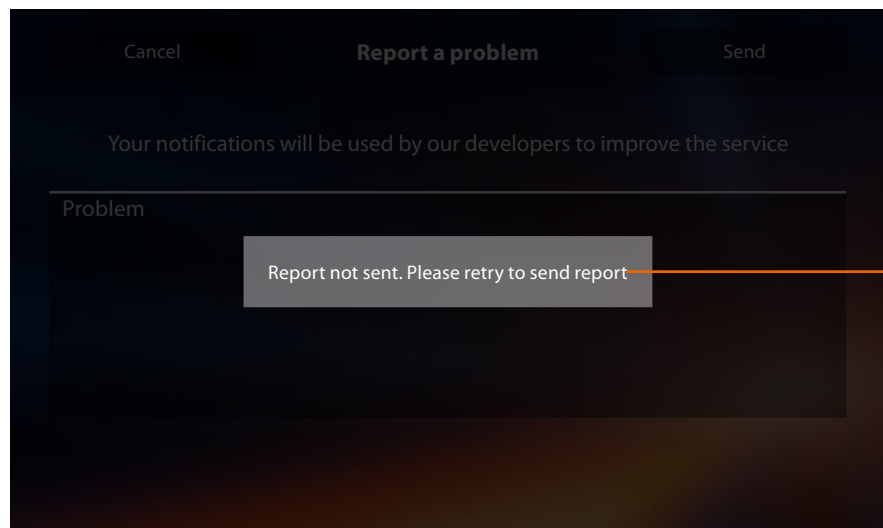

A. Display of the send notification message not successful.

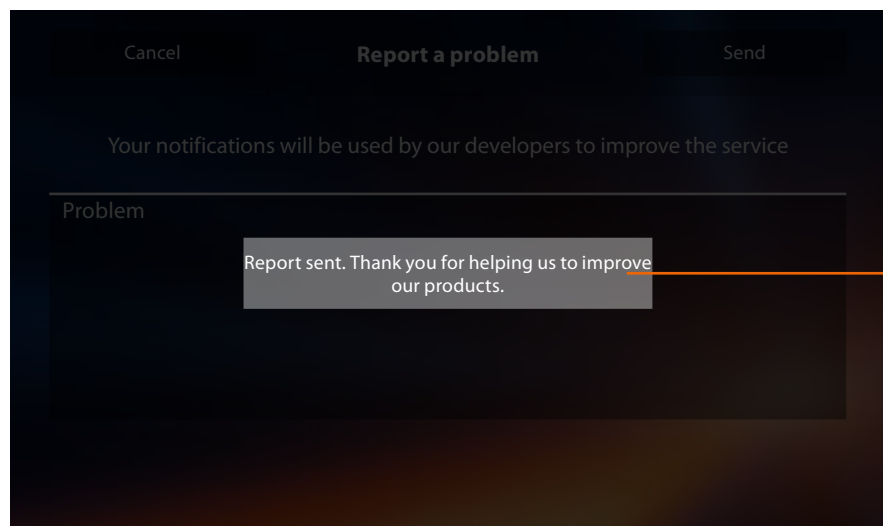

B. Display of the send notification message successful.

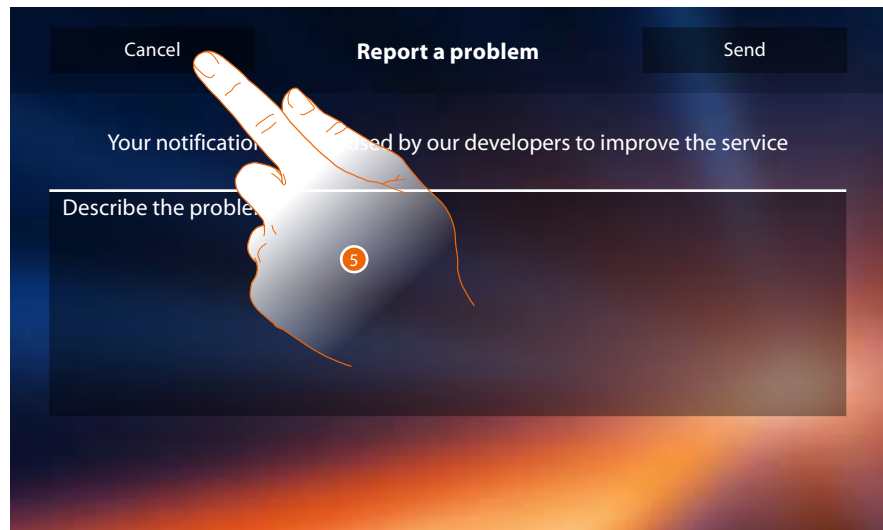

5. Touch to return to the previous page.

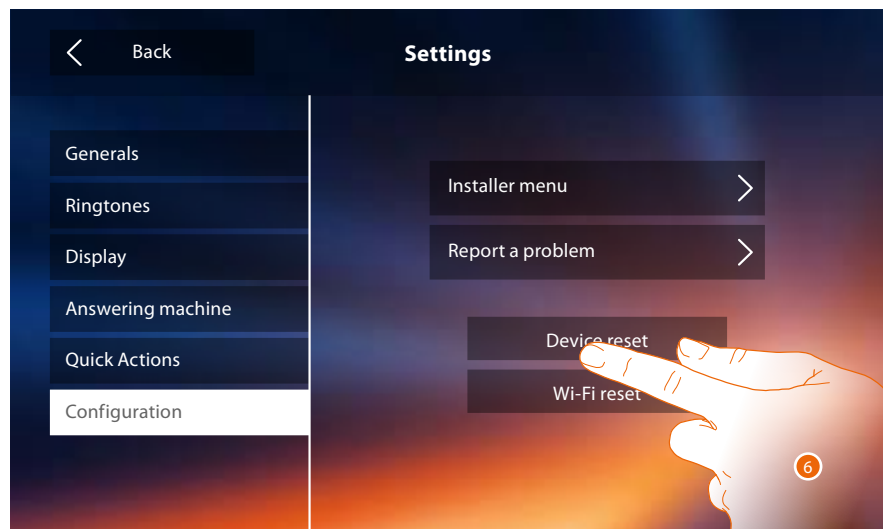

6. Touch to delete all the [associated accounts](#), the [messages in the answering machine](#), the notes.

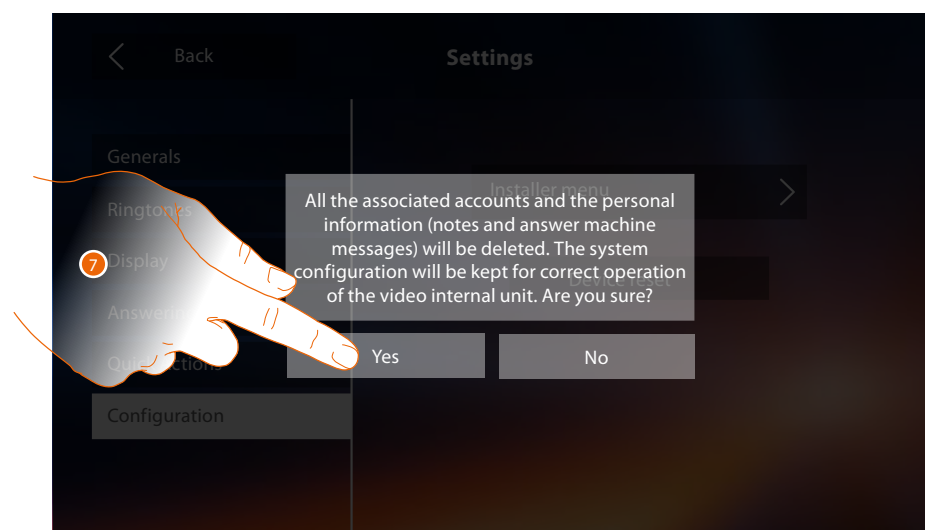

7. Touch to save it.

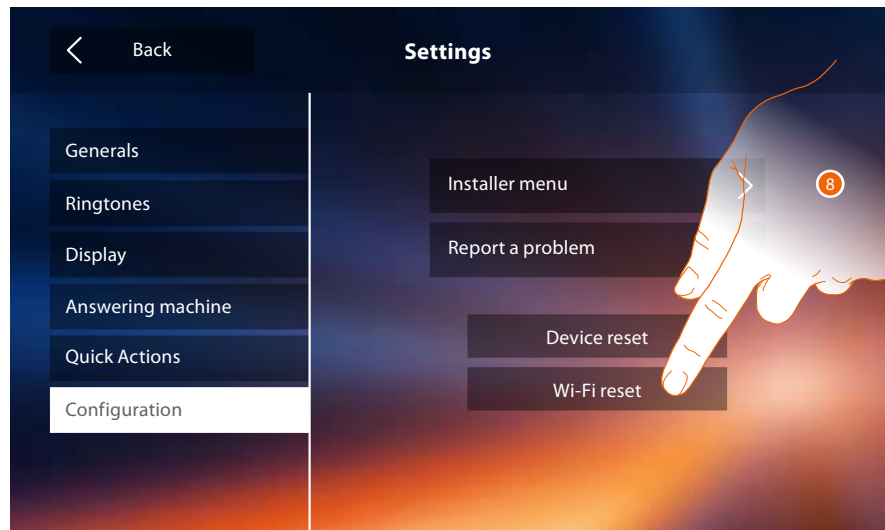

8. Touch to delete the Wi-Fi settings.

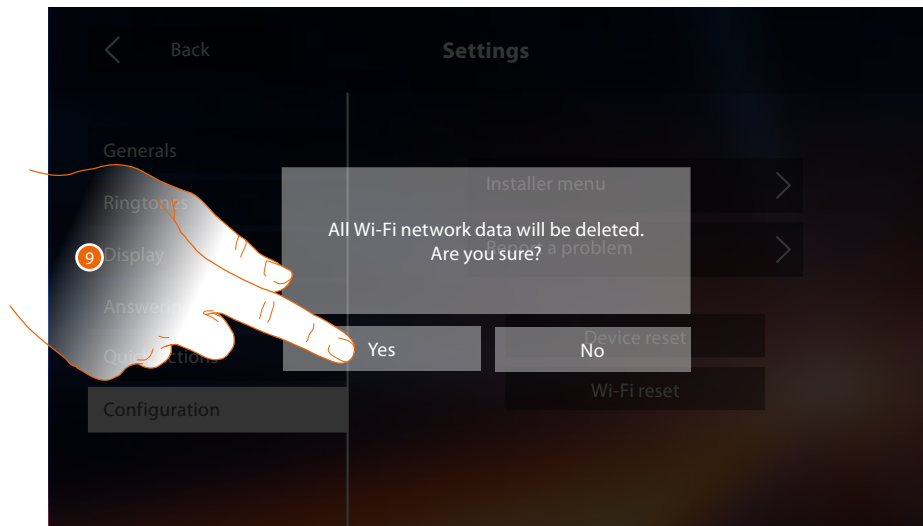

9. Touch to save it.

Note: once the data are cancelled, you must reenter the password of the Wi-Fi you want to connect to.

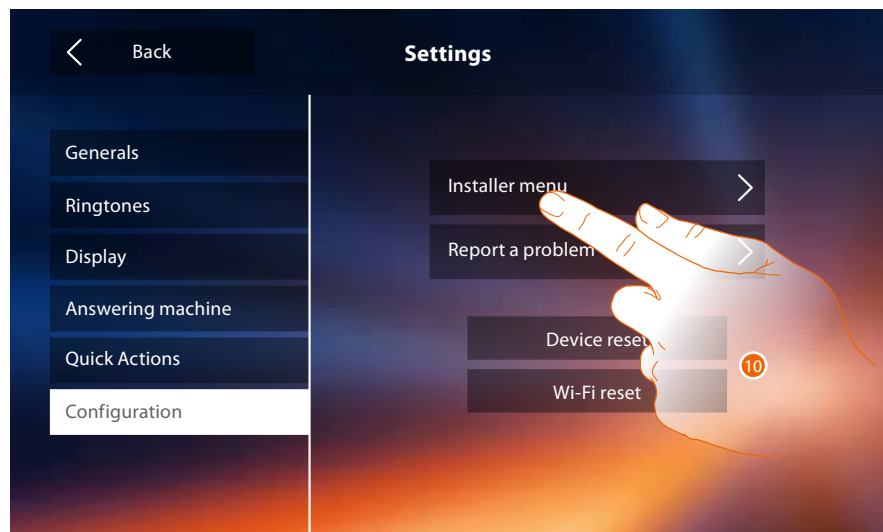

10. Touch to configure the device in advanced mode.
In order to access this section, the unlock code must be entered.

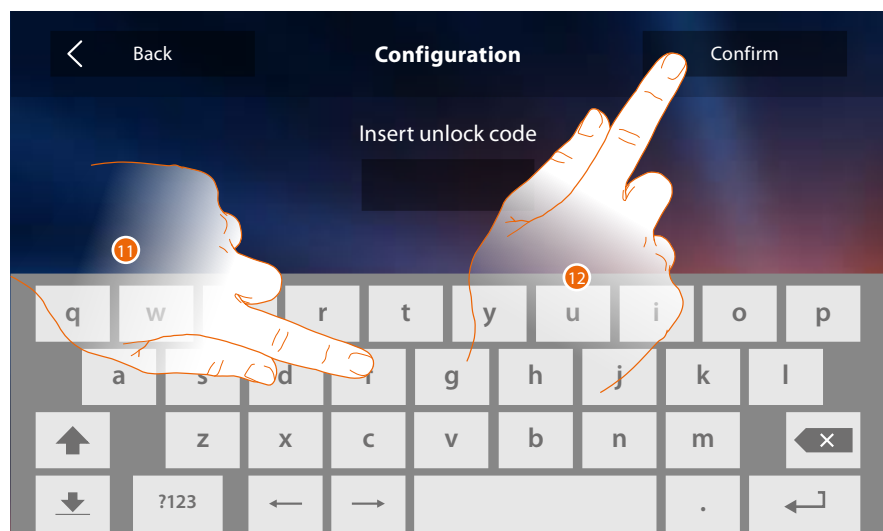

11. Enter the unlock code (default 12345).
12. Touch to save it.

General settings

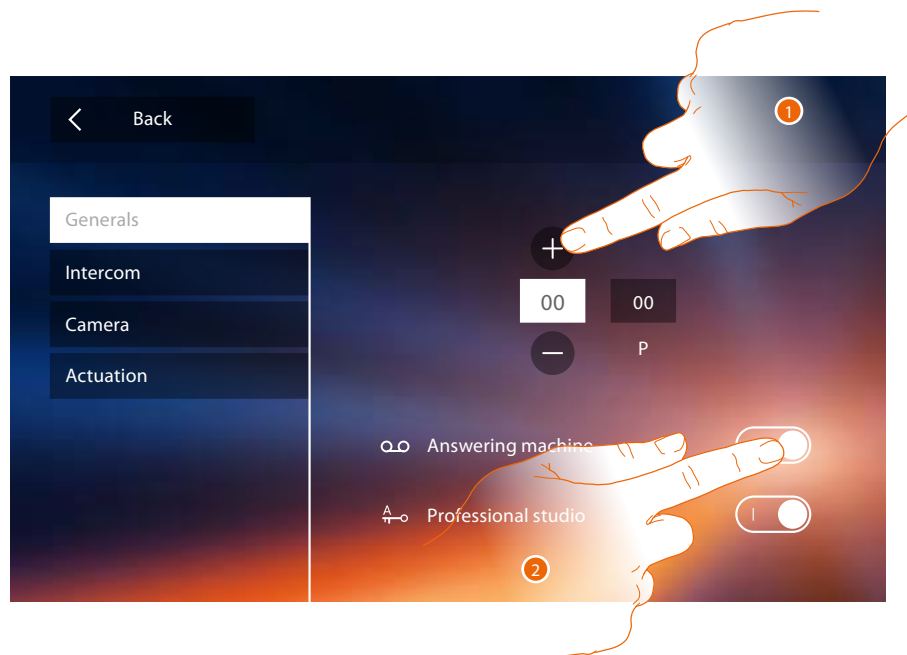

1. Enter the N configurator values to set the address device and enter the P configurator values to set the address of the EP of which you can open the Door Lock with IU idle, and to which you can send the auto-on command.

Note: the [function](#) configurations or modification on the Classe 300X will be automatically reported also in the [DOOR ENTRY APP](#) after the first association to a smartphone and for any subsequent modification.

2. Touch to make the functions available in the home page.

Intercom

This section can be used to configure the intercoms that will enable the user to communicate with other video/audio handsets installed in the home, or in other apartments, or to use the sound system as a pager, to call people.

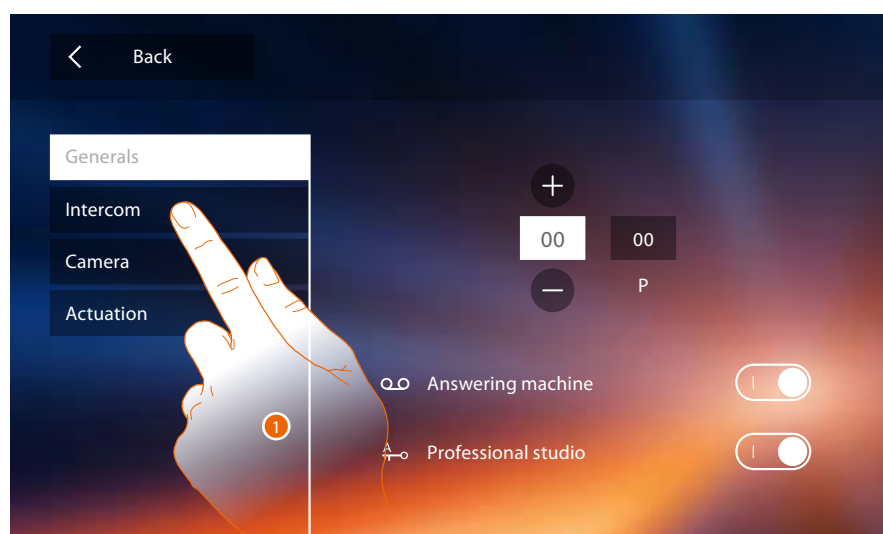

1. Touch to enter the Intercom section.

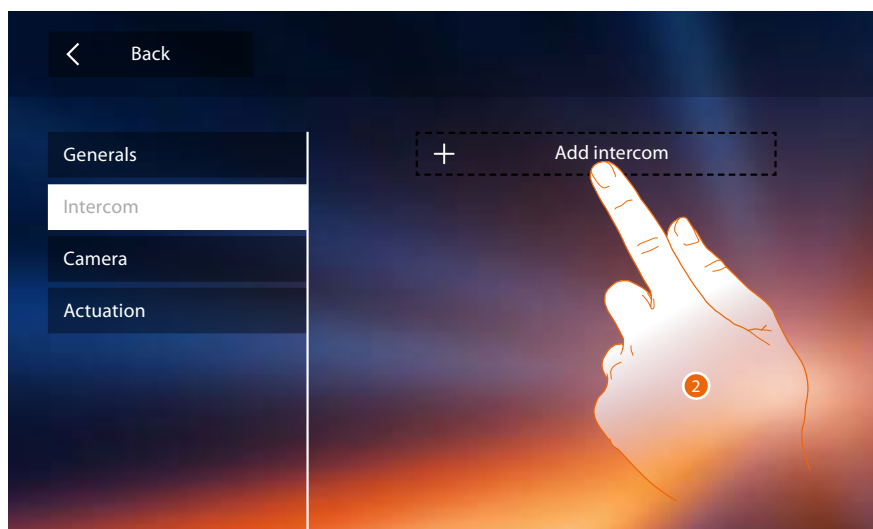

2. Touch to add an intercom.

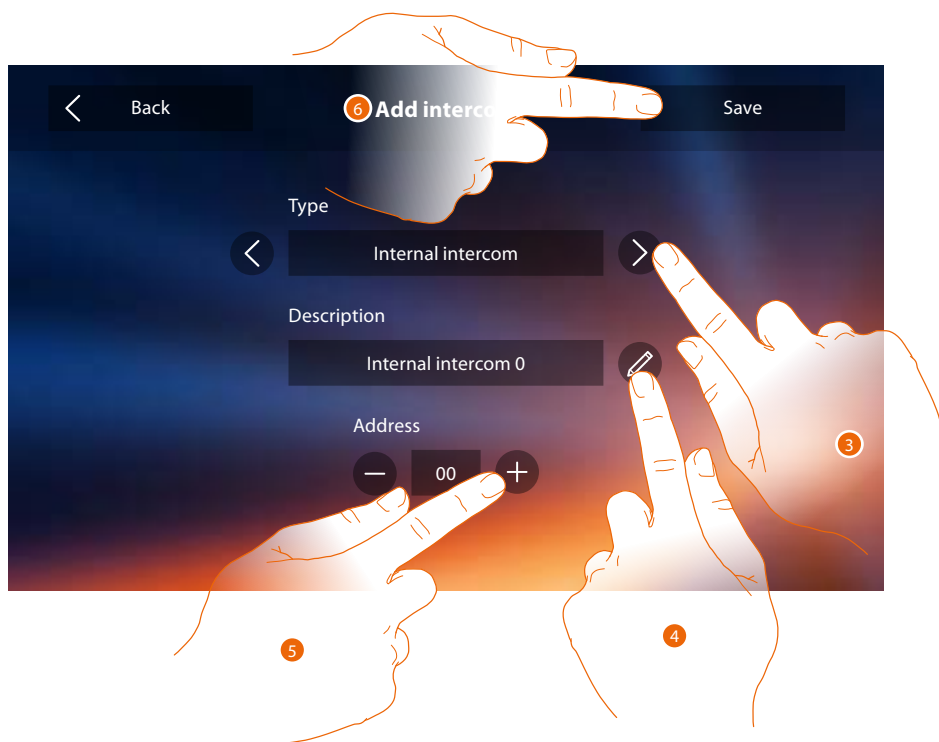

3. Select the type of intercom among:
- Internal:** it provides communication among rooms of the same apartment (or among devices of different apartments but only if there are no apartment interfaces)
 - External:** it provides communication among rooms of different apartments (if there are apartment interfaces)
 - Paging:** it provides communication with the sound system
 - General:** it provides communication with all internal units
- Note: if no apartment interface has been installed in the system, the call will be made to all residents, otherwise it will remain within the apartment.*
4. Change name.
5. Enter address:
- Internal:** address of the device wired in the same apartment
 - External:** address of another apartment
6. Touch to save.

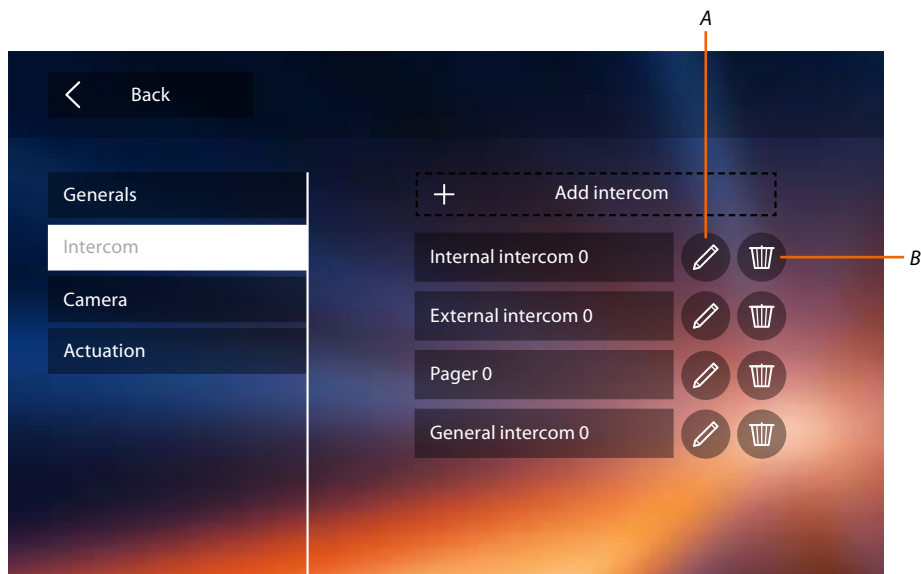

- A. Change the name of the intercom.
- B. Delete intercom.

Camera

This section can be used to configure the cameras that will give users the possibility of displaying the images from their own apartments, the apartment block area, or a CCTV surveillance system.

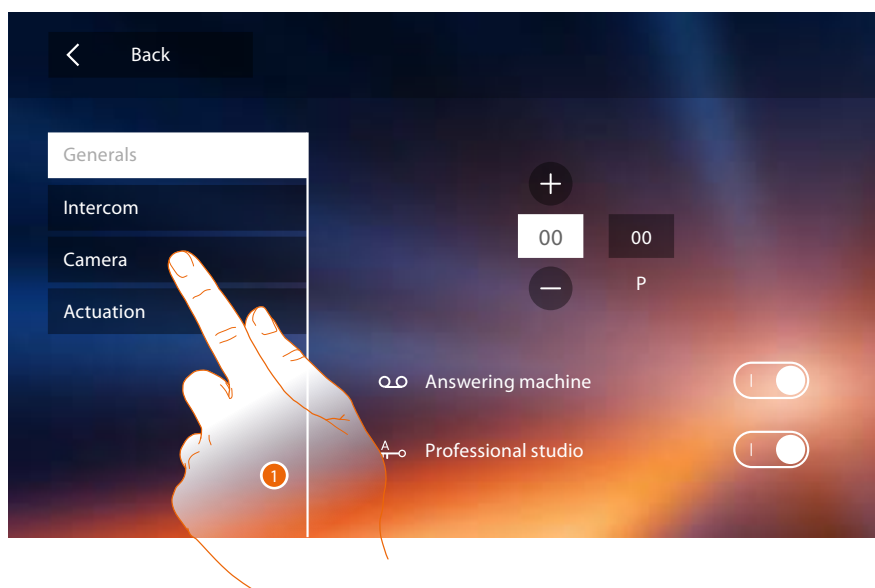

- 1. Touch to enter the Camera section.

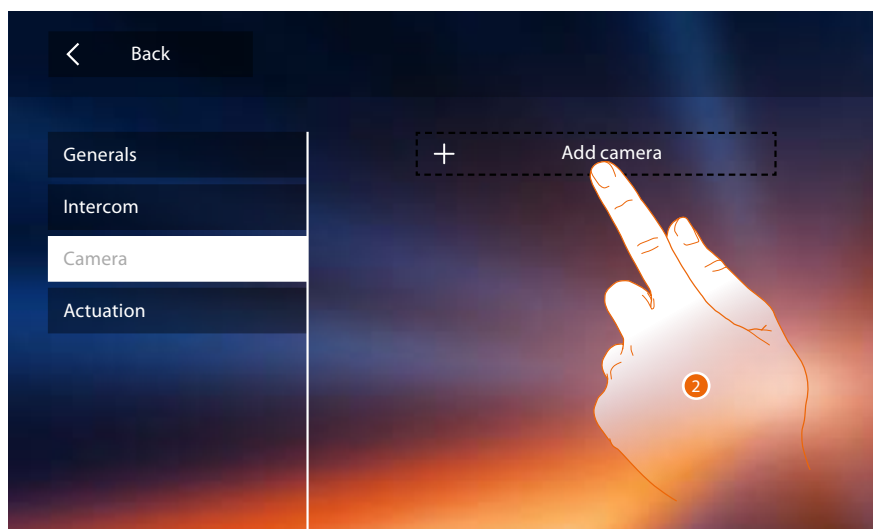

2. Touch to add a camera/entrance panel.

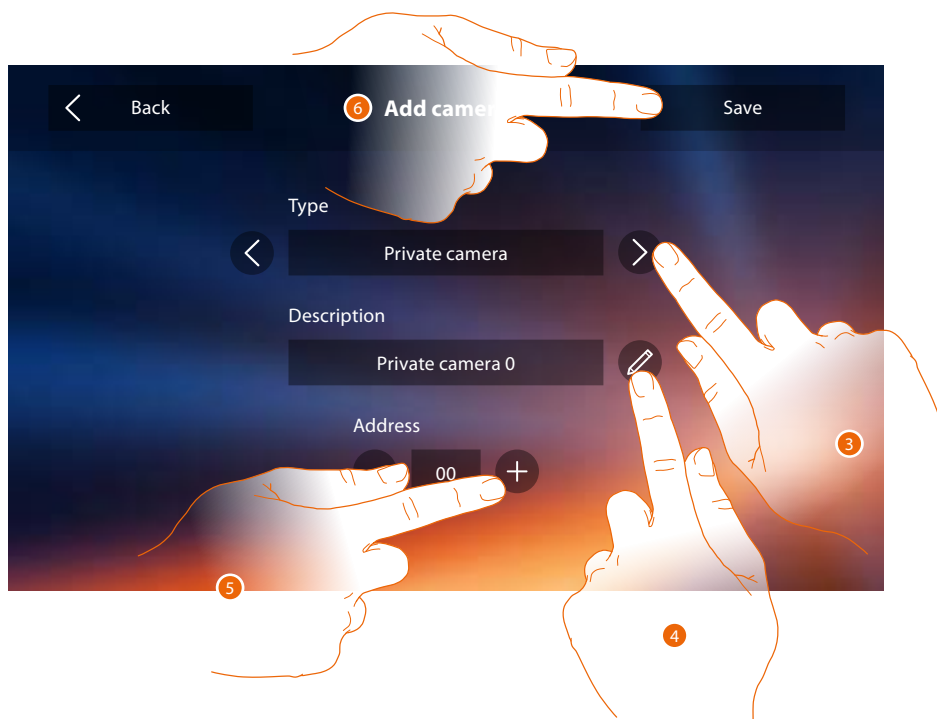

3. Select the type of camera/entrance panel among:
 - Private:** it gives the possibility of displaying the images from a camera/entrance panel installed in the own apartment (if an apartment interface has been installed)
 - Public:** it gives the possibility of displaying the images from a camera/entrance panel installed in a common area, visible to all residents (if an apartment interface has been installed)

Note: for apartment blocks without apartment interface and in single-family homes, cameras must be considered as PRIVATE.

CCTV: it gives the possibility of displaying the images from a camera of a video video surveillance system integrated with the video door entry SCS system.

The image is displayed for three minutes and the camera cycling is not possible. For the camera cycling or multi-vision functions, connect interface 347400 to a device output (e.g. Digital Video Recorder) performing these functions.

Note: to realize this integration, refer to the guides or the diagrams of the SCS/coaxial interface 347400.

Note: the [function](#) configurations or modification on the Classe 300X will be automatically reported also in the [DOOR ENTRY APP](#) after the first association to a smartphone and for any subsequent modification.

4. Change name.
5. Enter the address of the camera/entrance panel
6. Touch to save.

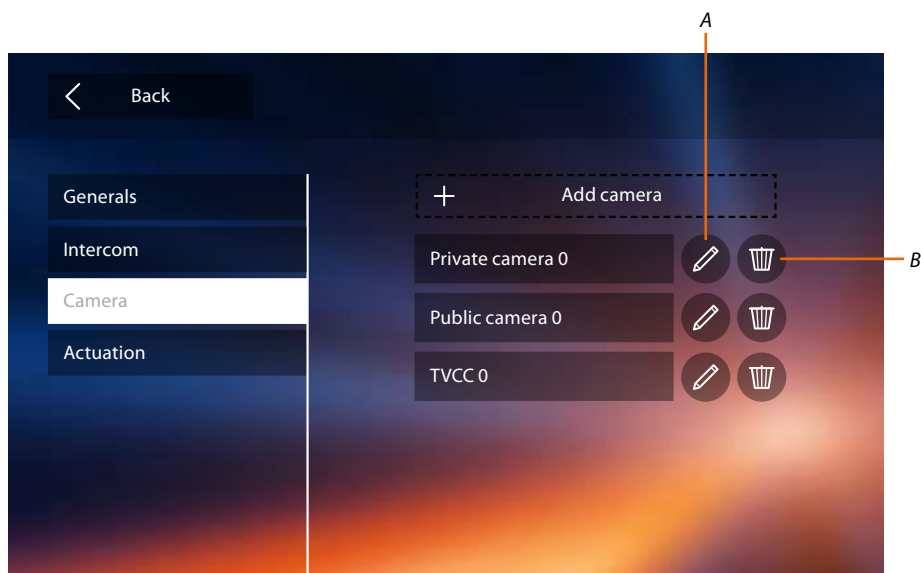

- A. Change the name of the camera/entrance panel.
- B. Delete camera/entrance panel.

Activation

In this section it is possible to configure the actuators in your system (e.g. door lock, garden light, etc.) and to activate them for the user.

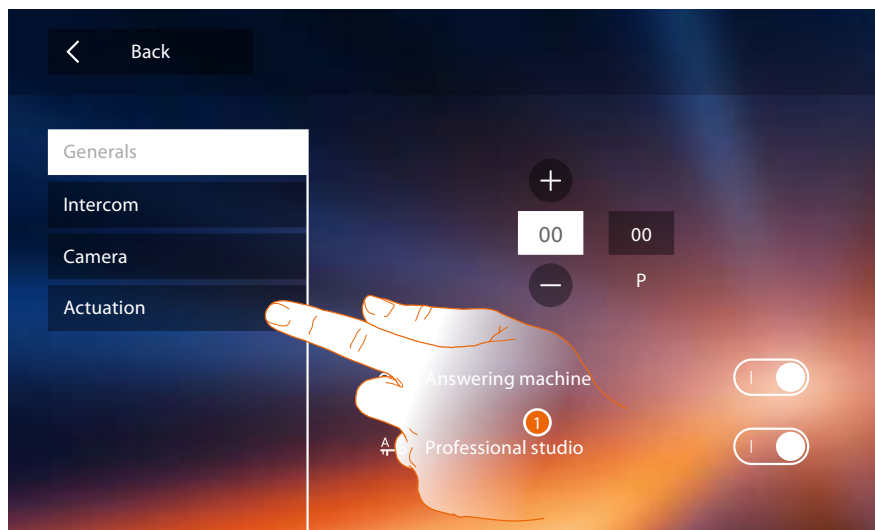

1. Touch to enter the Actuation section.

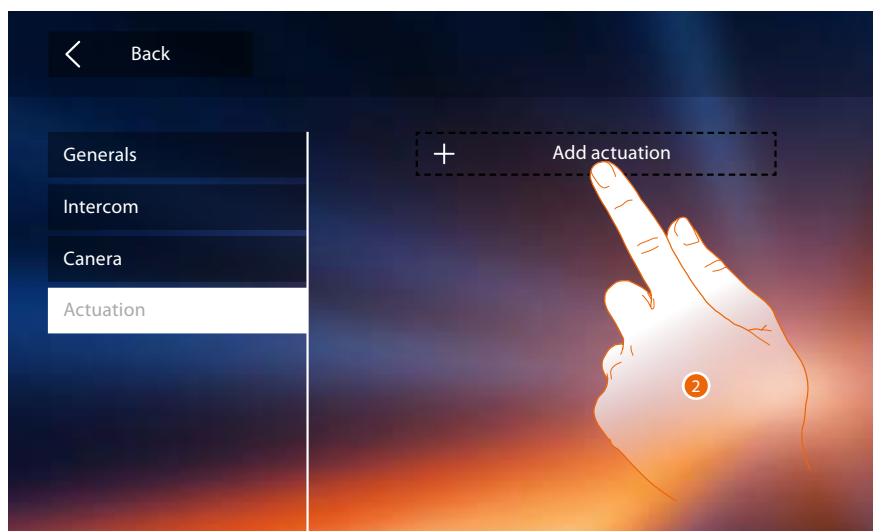

2. Touch to add an activation.

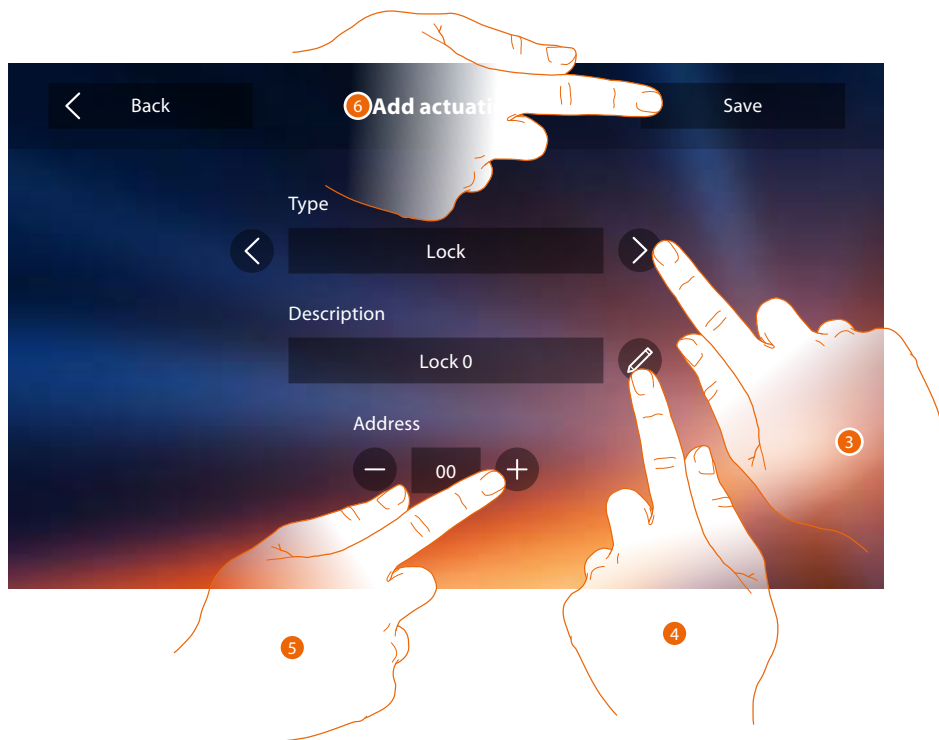

3. Select the type of activation among:
Lock: it is possible to activate a door lock actuator

Note: the [function](#) configurations or modification on the Classe 300X will be automatically reported also in the [DOOR ENTRY APP](#) after the first association to a smartphone and for any subsequent modification.

Generic actuator: it is possible to activate a generic actuator

4. Change name.
5. Enter the address of the actuator
6. Touch to save.

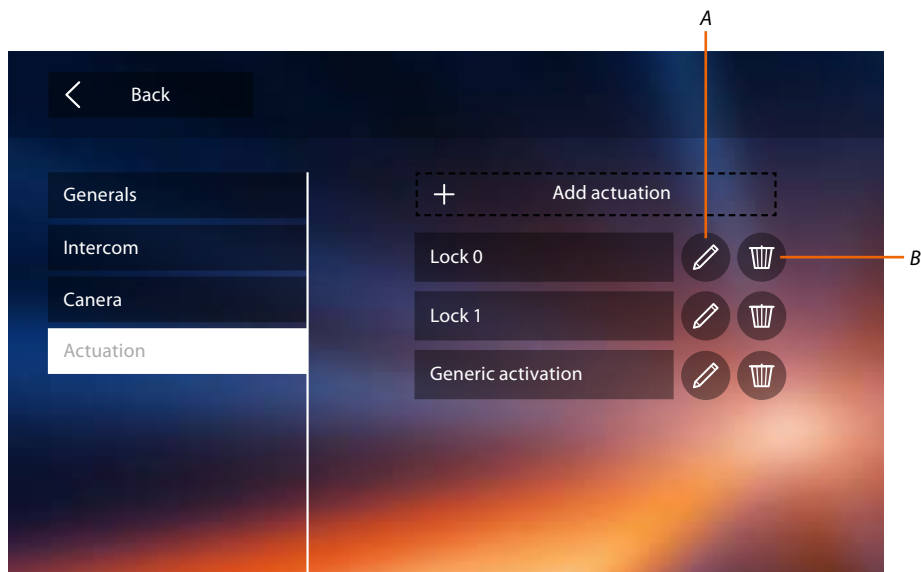

A. Change the name of the activation.

B. Delete activation.

Once the system functions have been configured, some can be made available to the users, giving them the possibility of selecting the 4 Quick Actions to display in their home page.

Quick actions

Note: before using these functions, insert the relevant functions in the [“Configuration”](#) section.

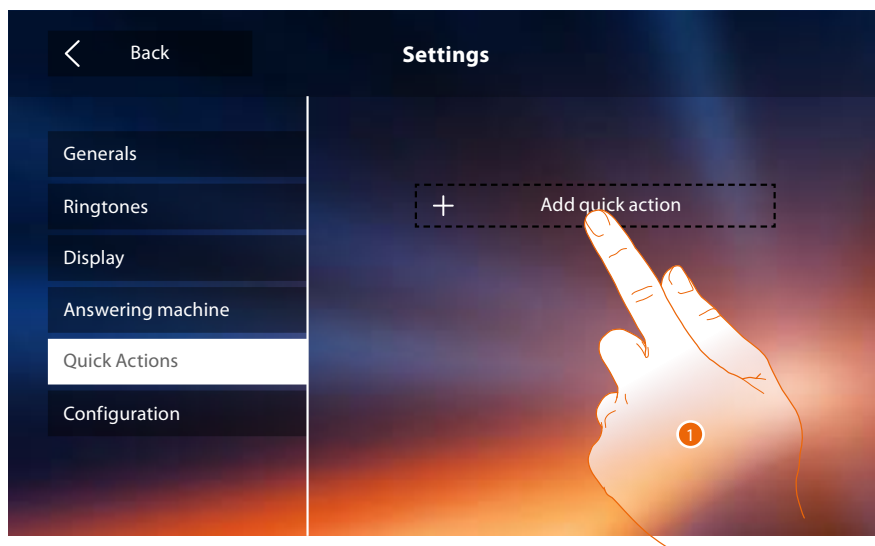

1. Touch to add a quick action.

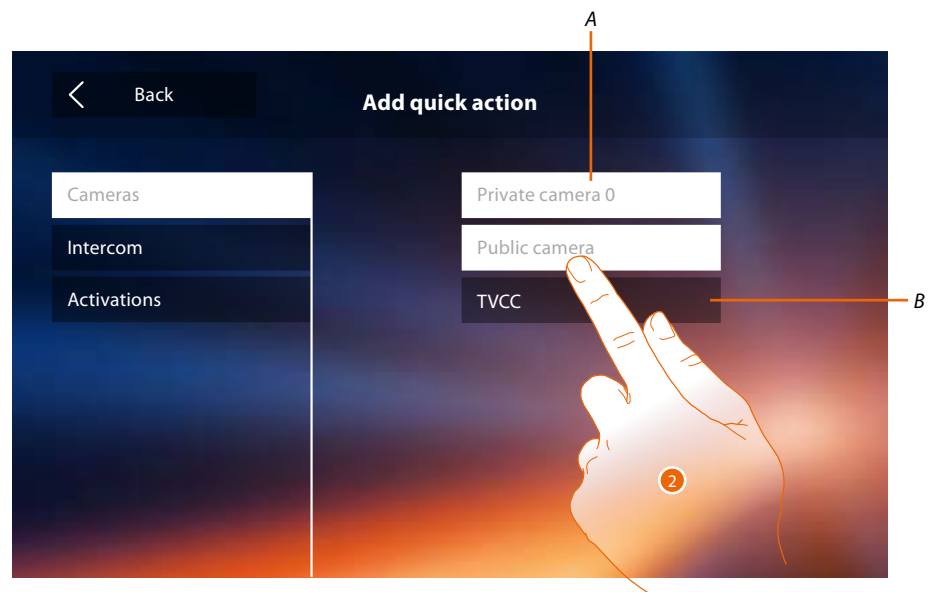

- A. Available Functions.
 - B. Function already used as quick action.
2. Touch to select the function to be used as quick action.

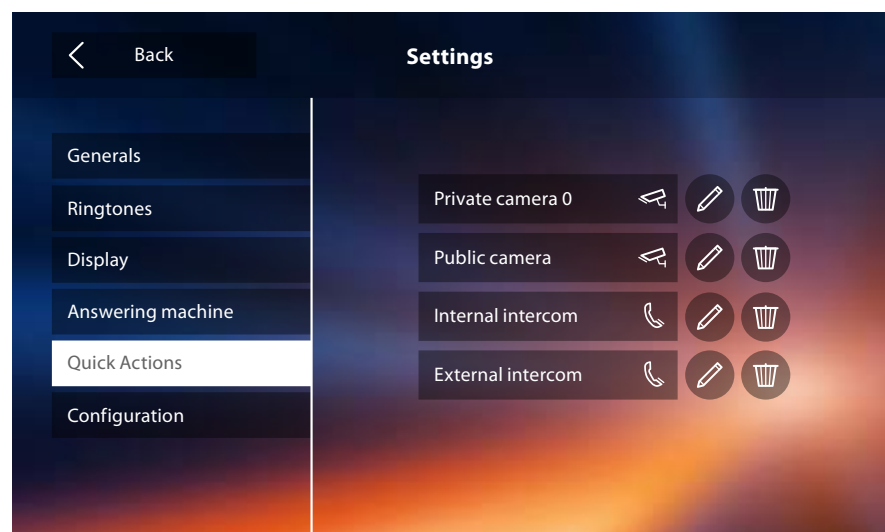

It configures up to 4 quick actions.

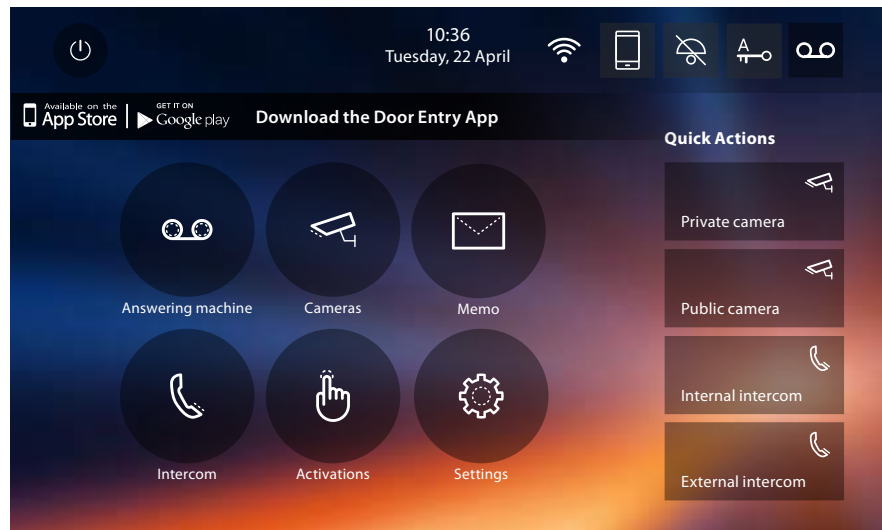

Now the quick actions appear in the home page.

Factory configuration

- Beep: OFF
- Professional Studio (Office): OFF
- Wi-Fi: OFF
- Type of ringtone:
 - Main Entrance Panel S0 = 2
 - Secondary Entrance Panel S1 = 11
 - Secondary Entrance Panel S2 = 5
 - Secondary Entrance Panel S3 = 4
 - Floor call = 7
 - Notifications = 13
 - Internal intercom = 1
 - External intercom = 16
- Default background: Home
- Unlock code: 12345

Device potential

- Memory and memos:
 - (Model 344622 only) 25 x 15" high resolution movies (warning, when the maximum limit is reached, the most recent overwrites the oldest one)
 - (Model 344622 only) 150 x 15" low resolution movies (warning, when the maximum limit is reached, the most recent overwrites the oldest one)
 - 20 audio memos (warning: when the maximum limit is reached, the most recent overwrites the oldest one)
 - 50 written memos (warning: when the maximum limit is reached, the most recent overwrites the oldest one)
- Configurable controls:
 - Max. No. of door locks: 50
 - Max. No. of generic activations: 50
 - Max. No. of direct activations: 50
 - Max. No. of internal intercoms: 40
 - Max. No. of external intercoms: 40

Note: for the maximum number of devices and their configuration on the system, always refer to the technical guide.

TROUBLESHOOTING

PROBLEM	SOLUTION
The internal unit rings but does not turn on	Check that the jumper2 is in the housing, that there are at least 18V, that the jumper1 is not inserted if it is locally supplied
The internal unit does not ring and does not turn on	Check that there are at least 18V, check the device configuration and that the ringtone is not disabled
The call arrives but the audio is low	Check the volume adjustments in the video internal unit menu, if the problem appears on all the video internal units of the system, check the volume level on the entrance panel (refer to the entrance panel instructions)
The call is not forwarded to the smartphone	<p>Make sure that the Classe 300X switches its monitor on when a call arrives</p> <p>Check that the user used to access the App is correctly associated to the Classe 300X</p> <p>If necessary, perform the association procedure or ask another user already associated to invite you.</p> <p>Check that date and time are correct..</p>
It is not possible to associate the smartphone to the Classe 300X	<p>Check that the smartphone and the Classe 300X are connected to the same Wi-Fi network, check that this Wi-Fi network is connected to the Internet and can surf, check that there are no accounts already associated, if necessary ask to be invited using the appropriate function.</p> <p>If the associated account was the previous resident, delete all the accounts/memos and messages using the appropriate function in the Classe 300X menu.</p> <p>Check that date and time are correct.</p>

