

# CLASSE 300

## Connected Video Door Entry Systems

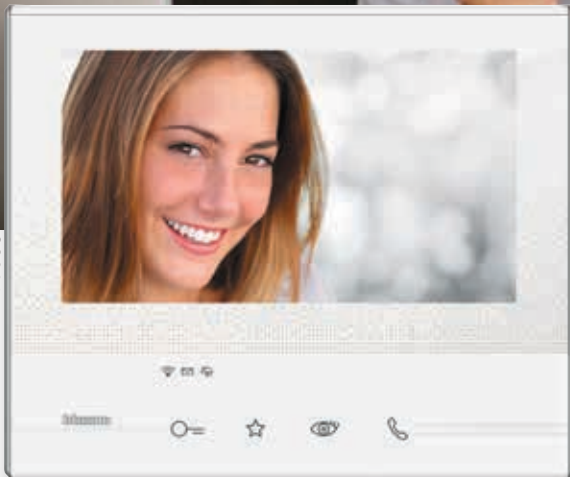

CATALOGUE  
PAGES  
INSIDE



The new **CLASSE 300X13E** video internal unit allows you to transform every home into a connected home, which can be easily controlled in the home or remotely using a smartphone.



Eliot is the BTicino program dedicated to connected objects (Internet of things) which identifies all those products or systems which, because they can connect to the Cloud, give added value in terms of functionality, information, interactions with the environment and use.

## Contents

4-17			
CLASSE 300X13E	Modern, connected, simple		4
	What can you do with CLASSE 300X13E?		6
	The advantages		10
	Door Entry App – Designed for the final user		12
	Immediately connected and configured		14
	Perfect to replace your old 2 wires internal unit		16
18-23			
CLASSE 300	CLASSE 300 - A stylish choice		18
range	A simple approach to everyday gestures		22
General			
features			
24-27			
CLASSE 300	Features and functions		24
range	Catalogue		26
Catalogue	Dimensional data and legal notes		27

# CLASSE 300X13E

The pictures shown on the display are exclusively for illustrational and promotional purposes.



MODERN  
**CONNECTED**  
SIMPLE

# The easy to use Bticino 2 wire technology has the advantage of connection for **more functions and extra services**

CLASSE 300X13E is the new connected video internal unit which combines modernity and innovation thanks to the communication between smartphone and video internal unit. The integrated Wi-Fi connectivity allows the connection (\*) with your

smartphone and, thanks to the dedicated App, you can manage the video door entry calls in an innovative and functional way. Featuring a wide 7" Touchscreen display, it is ideal for all clients who care about technology and innovation, thanks to its unique design.



## **Always in contact with your home**

The possibility of managing the different functions using a smartphone is added to the installation simplicity offered by the CLASSE 300X13E. Both inside and outside the home you will be able to manage calls, open the gate, activate the camera or operate the timed garden lights... Everything with a simple touch!

NOTE (\*): for the connection you need a home Wi-Fi network with Internet access. See LEGAL NOTES section on page 27.





# WHAT CAN YOU DO WITH CLASSE 300 X13E?

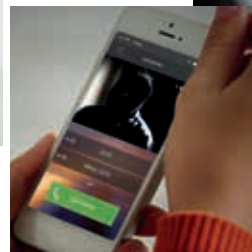
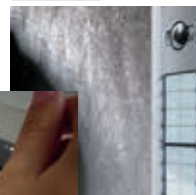
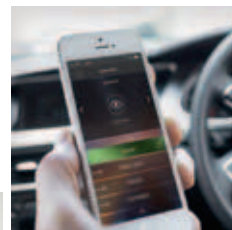

It is possible to manage various functions using the (**free**) App for Android and iOS smartphone\*

## ANSWER COMFORTABLY FROM YOUR HOME SOFA

Absolute freedom of movement inside your home. You can answer the video door entry call from any room of your home.

Hi Anna, come in, I'll open the door immediately!

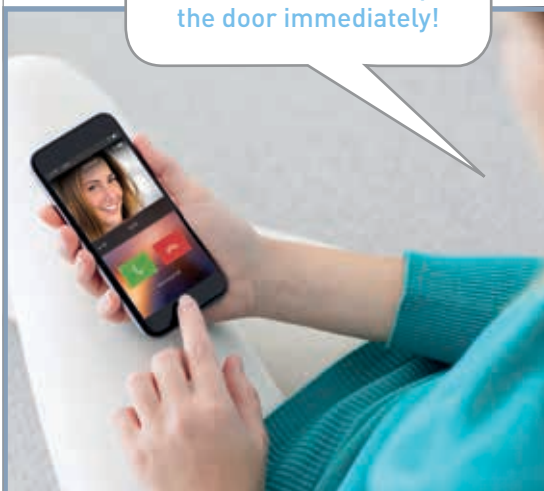

## ANSWER THE CALL WHEN YOU ARE OUT AND FROM ANYWHERE IN THE WORLD

When you are out, on holiday, in the office, you can answer the video door entry call wherever you are.

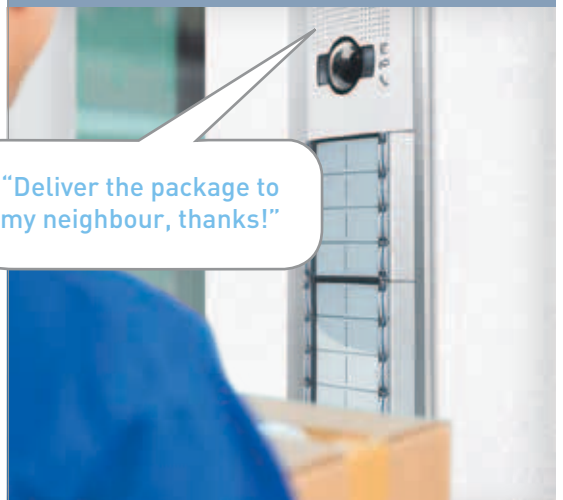

## WHAT CAN YOU DO WITH CLASSE 300X13E?

### CALL HOME DIRECTLY

Always keep in touch with anyone at home. The smartphone is an intercommunicating terminal with your video internal unit.

Hi Anna, can you see if my purse is in the living room?



### OPEN THE HOME GATE WHEN YOU DO NOT HAVE YOUR RADIO CONTROL

You return home by car and cannot find your gate radio control? No problem, you can open the gate with your smartphone.

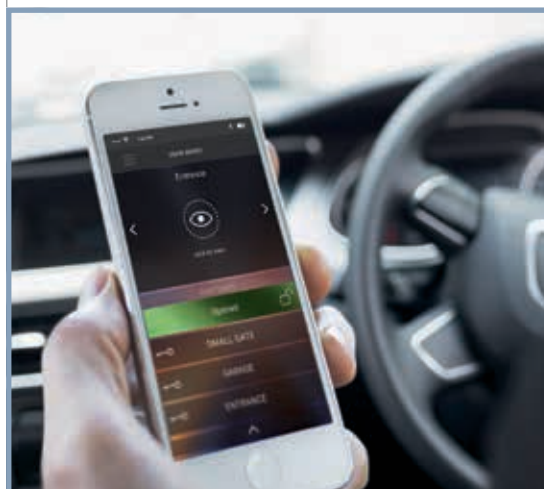

**NOTE:** all the door locks connected to your 2 wires video door entry system can be controlled by smartphone.



## SEE WHAT IS HAPPENING AT HOME

More security for your home. Using your smartphone you can activate the external and internal cameras connected to your video door entry system.



**NOTE:** all the cameras connected to your 2 wires video door entry system can be controlled by smartphone.

## SWITCH ON THE LIGHT OR WATER THE GARDEN

Even when you are out or on holiday, you can comfortably activate the garden watering and switch the lights on directly from your smartphone.

... and even the garden is watered!

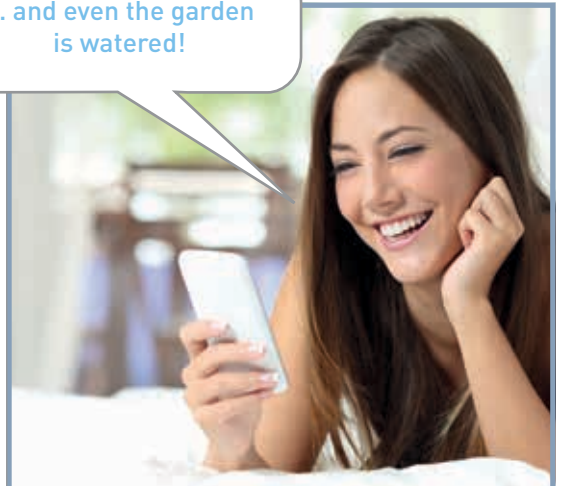

**NOTE:** the timed actuators connected to your 2 wires video door entry system can be controlled by smartphone.

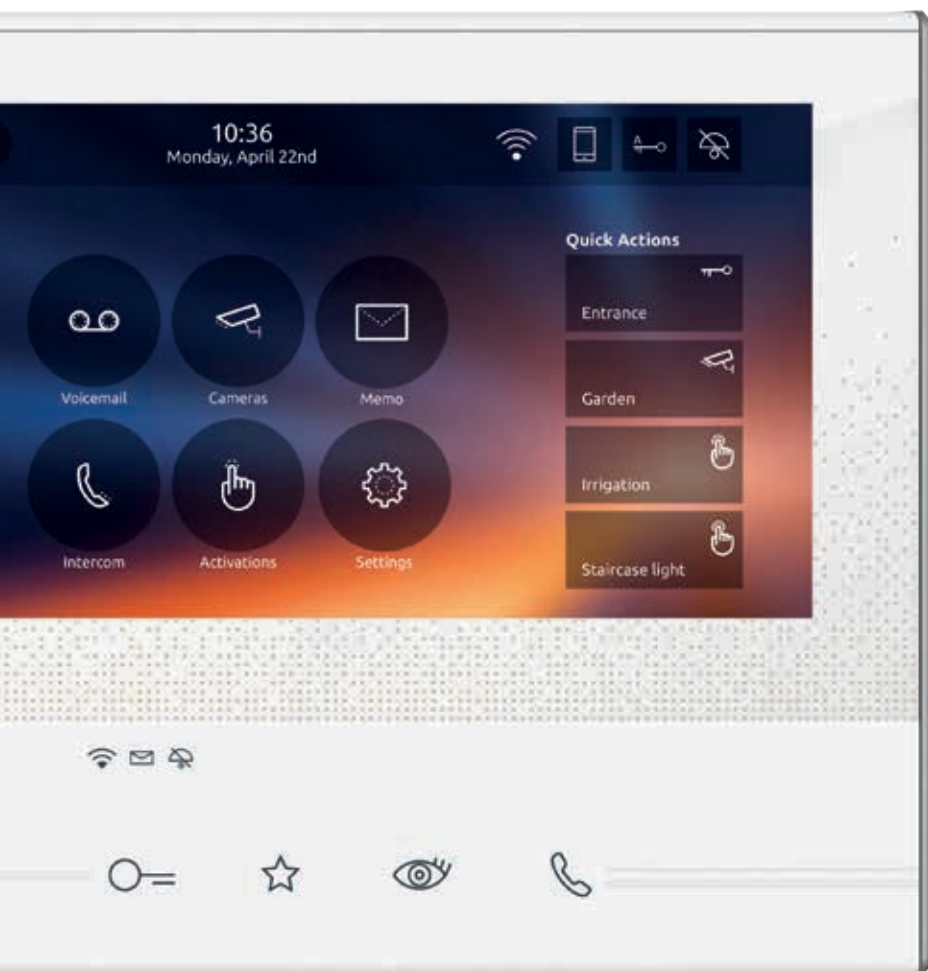

## 2 wires standard installation

Thanks to the integrated Wi-Fi connectivity, Classe 300X13E does not require work on the walls and follows the **same installation rules** as a "normal" 2 wires video internal unit.



# THE ADVANTAGES

## CLASSE 300X13E DOES NOT CHANGE THE INSTALLATION RULES

**Forget installation complexity and configuring an Ethernet network and keep the simplicity of a 2 wire connection. Everything stays the same thanks to the Wi-Fi technology integrated in the video internal unit.**



### Simple and intuitive configuration

The configuration requires no IT skills. You must only configure the classic 2 wires system parameters (entrance panel and internal unit SCS addresses, etc.). Your customer manages all the configurations

of the Wi-Fi network and the App independently and intuitively.

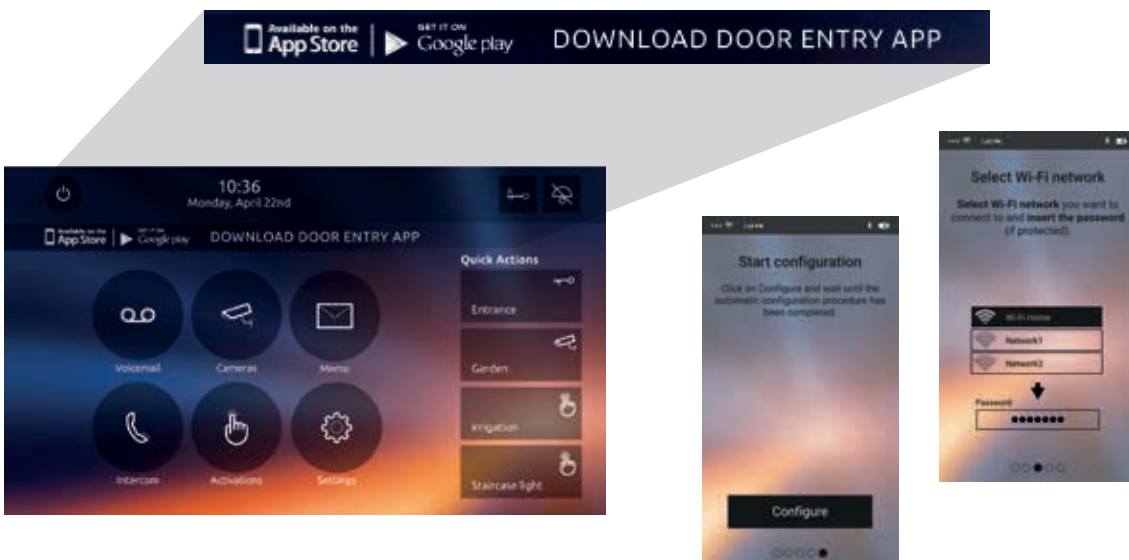

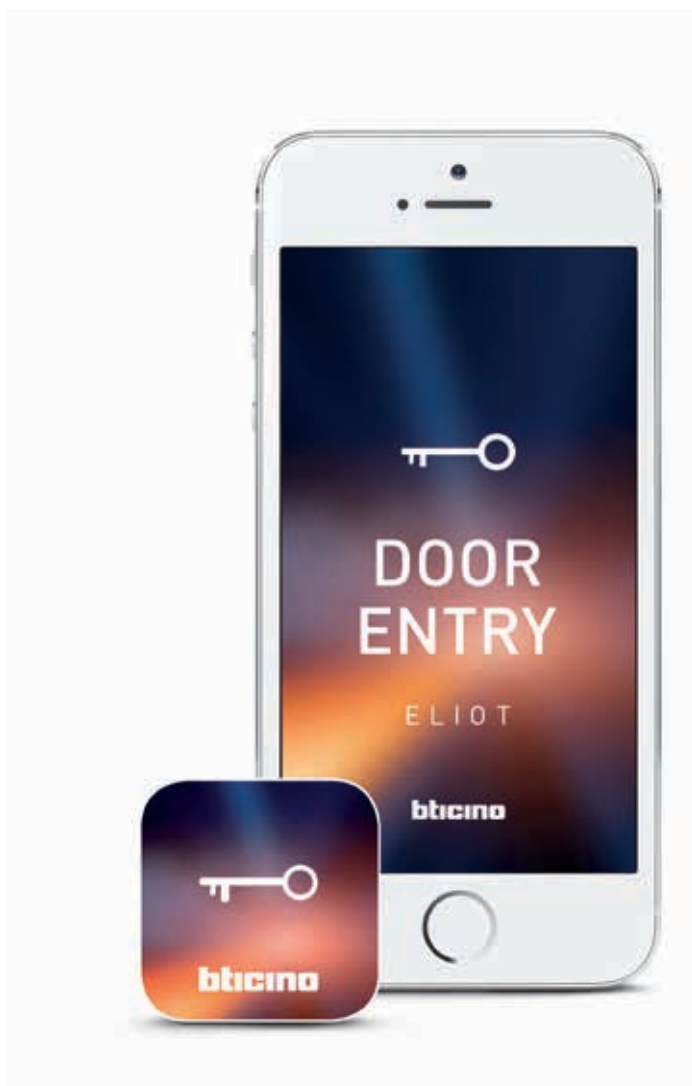

DOOR ENTRY is the App which lets you, using your smartphone, manage the video internal unit calls locally and remotely or with a simple touch, open the gate, activate the cameras and switch the garden timed lights on. Configuring the App needs just a few steps and, thanks to the BTicino Cloud, the remote connection is totally automated and managed with the maximum level of security.

# DOOR ENTRY APP

DESIGNED  
FOR THE  
FINAL USER



Scan the QR Code with your smartphone and download the Android App.



Scan the QR Code with your smartphone and download the iOS App.

# User interface designed starting from the most commonly used functions.

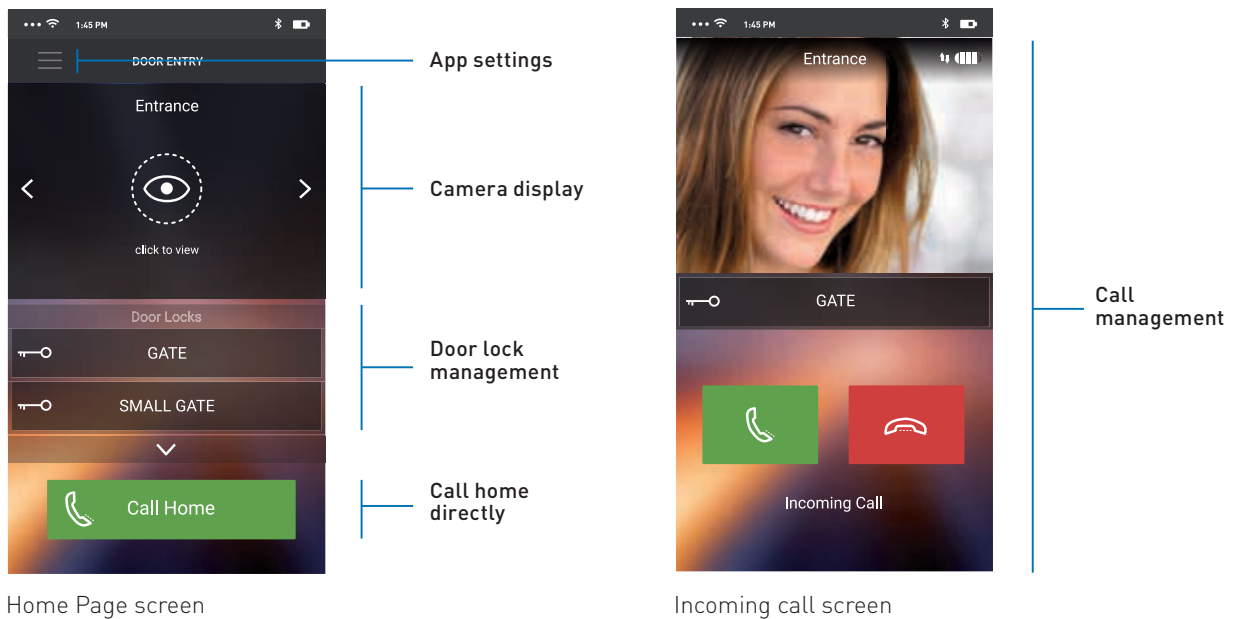



Home Page screen

Incoming call screen



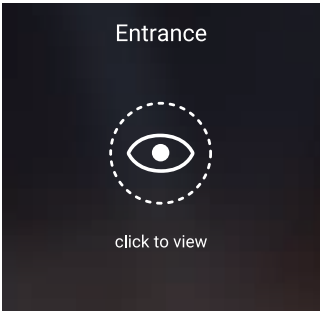
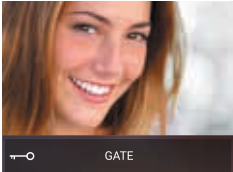

Select the camera and press to activate it



Answering the internal unit is as easy as answering a normal telephone call

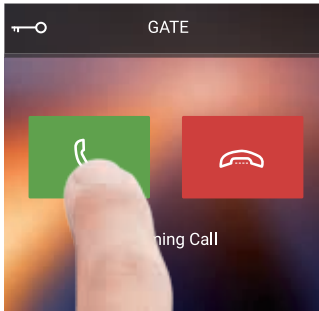
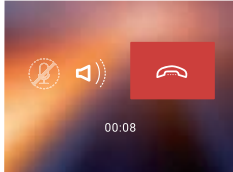

To open the door slide the key to the right – you will avoid opening the door accidentally

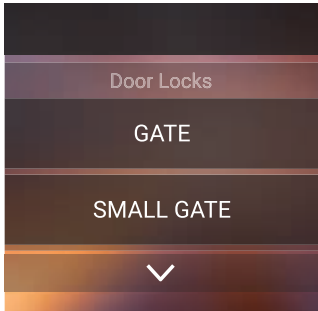
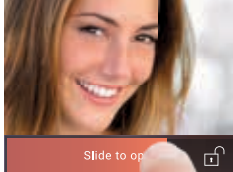

# IMMEDIATELY CONNECTED AND CONFIGURED

After installing the App, a guided procedure allows the association between smartphone and CLASSE 300X13E in 3 simple steps.



1 Once the Wi-Fi connection is activated select the network you want to connect to



**2** Enter your Wi-Fi network password

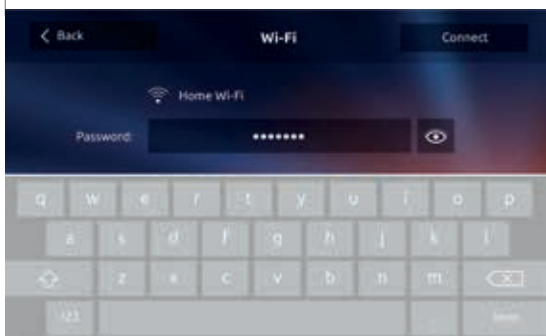

**3** Once the configure key is pressed, the App will search for the Classe 300X13E and will connect automatically, self-configuring

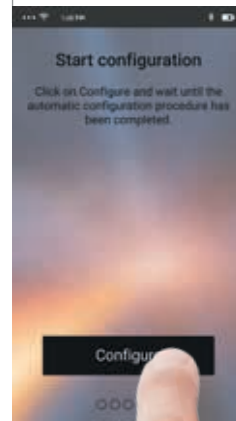

**LOCAL**



The connection to the dedicated Cloud totally automates the configuration on the home network (you do NOT need to configure your router).

The video internal unit transfers all the configuration of the 2 wires video door entry system (cameras, door locks, activations etc.) to the App and updates automatically after each modification.

**REMOTELY**

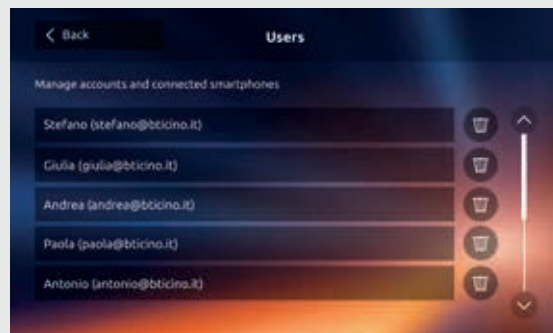
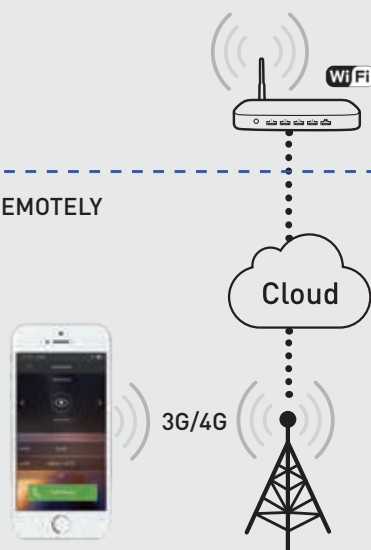

On the video internal unit you can always display the mobile devices associated to it and decide which to disconnect or cancel at any time.

# PERFECT TO REPLACE YOUR OLD 2 WIRES INTERNAL UNIT



# Classe 300X13E is the best solution available for renewing your internal unit.

In existing **2 wires** systems you can update and replace your old internal unit (\*) or video internal unit with CLASSE 300X13E.

Thanks to the Wi-Fi connectivity, no extra wiring is required.

## Villa or single-family context

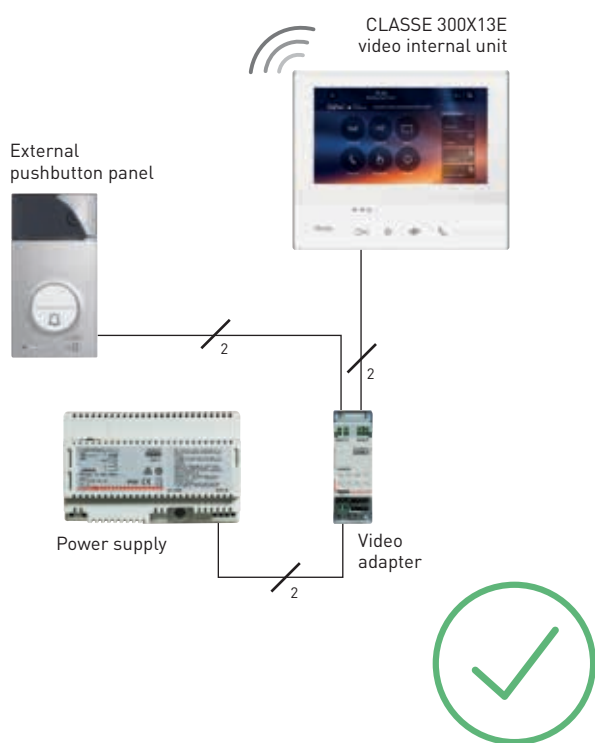

## Apartment block or multi-family context

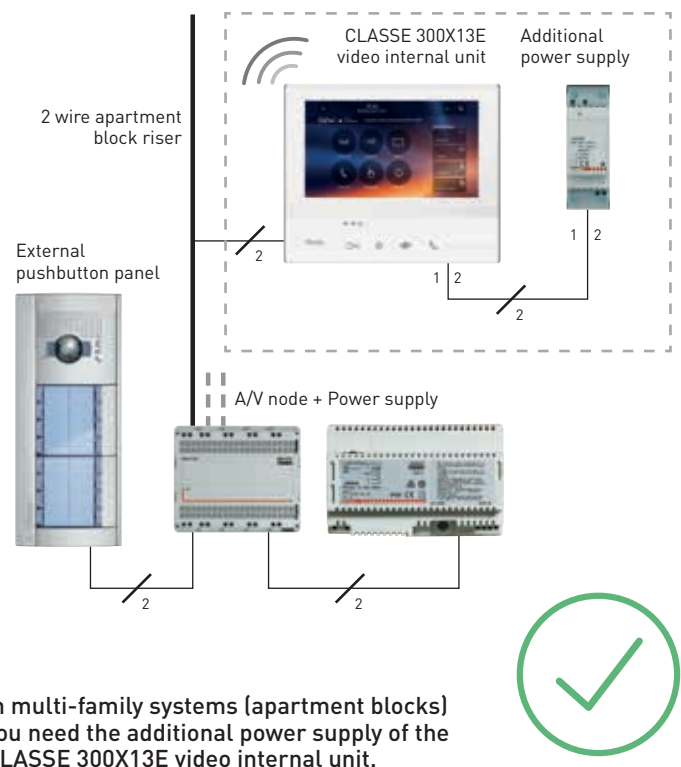

In multi-family systems (apartment blocks) you need the additional power supply of the CLASSE 300X13E video internal unit.

## Also suitable for renewing the entire system.

CLASSE 300X13E has 2 wires technology. Unlike solutions based on Ethernet/IP systems, the 2 wires technology is the **best solution for refurbishments** because a pair of existing wires can be used.



(\*) Only the audio call will be transferred

The pictures shown on the display are exclusively for illustrational and promotional purposes.



# CLASSE 300

## A STYLISH CHOICE





## Elegant design and modern technology

CLASSE 300 is the range of handsfree video internal units with a wide **7" Touchscreen** display enhanced by the glass effect finish.

The curved and metalised profile with rounded corners helps to cancel the perception of thickness giving it a **STYLISTIC LOOK**.



The main functions can be activated by means of **TOUCH SENSITIVE** keys placed in an easily identifiable area with **TACTILE GUIDE** for easier recognition.



CLASSE 300 has been awarded this prestigious international recognition confirming BTicino's capacity in combining technology and design.

# CLASSE 300 A STYLISH CHOICE



CLASSE 300X13E combines unique and innovative style with advanced technology which allows absolute freedom, thanks to the Wi-Fi connection.





**CLASSE 300 is available in two finishes, light and dark. It can be wall mounted or it can rest on a table.**



Light finish



Dark finish



Table-mounted installation with accessory supporting frame 344632



The **TOUCH SENSITIVE** capacity keys which control the main video door entry functions come with tactile guides for easier recognition.

# A SIMPLE APPROACH TO EVERYDAY GESTURES



Door lock release



Camera activation



Favourites which can be configured



Handsfree communication



# Intuitive access to all functions



Allows access to the visitors you want



Answer your visitor calls



You can adjust the screen settings and select from different backgrounds and ring tones



See what is happening outside  
You can see the pictures from the external pushbutton panel camera or from the cameras connected to your system



Use the CLASSE 300 to communicate with the other rooms of your home or with other homes



You can decide that the CLASSE 300 opens the door automatically when you receive a call (you can activate and deactivate the function when you want)



If you need peace and quiet you can silence the CLASSE 300 and reactivate it when you want



You can activate other functions which are connected to your system, such as the staircase lights or the locks of other gates



Leave a message with the NOTE function



Activate the answering system function (only CLASSE 300X13E - CLASSE 300V13M), to record a film clip of the visitor who was looking for you. When you are out, you can record a message for people looking for you.





# CLASSE 300

## Features and functions

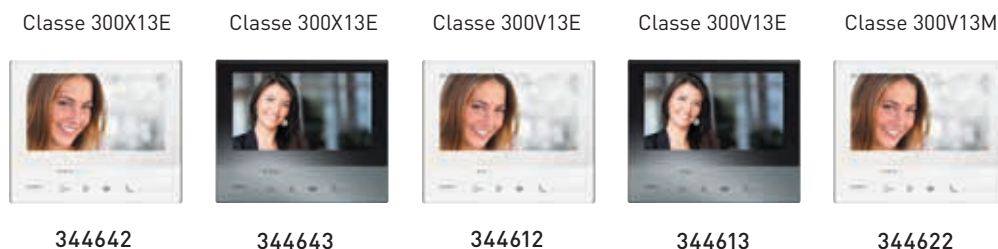

COLOUR VIDEO 7" TOUCH SCREEN	•	•	•	•	•
HANDSFREE	•	•	•	•	•
INDUCTIVE LOOP <sup>(1)</sup>	•	•	•	•	•
FINISH	light	dark	light	dark	light
INSTALLATION	wall / table	wall / table	wall / table	wall / table	wall / table
DOOR LOCK RELEASE	•	•	•	•	•
STAIRCASE LIGHT CONTROL	•	•	•	•	•
ENTRANCE PANEL/ SCROLLING ACTIVATION	•	•	•	•	•
INTERCOM <sup>(2)</sup>	•	•	•	•	•
MEMORY FUNCTION	•	•			•
NOTE FUNCTION	•	•	•	•	•
PROFESSIONAL STUDIO (OFFICE) FUNCTION	•	•	•	•	•
WI-FI CONNECTION	•	•			
AVAILABILITY IN KIT	•				•

1) Used by people wearing hearing aids fitted with T selector

2) Audio call, max. 3 minutes, between internal units of the same apartment/different apartments

## Front view

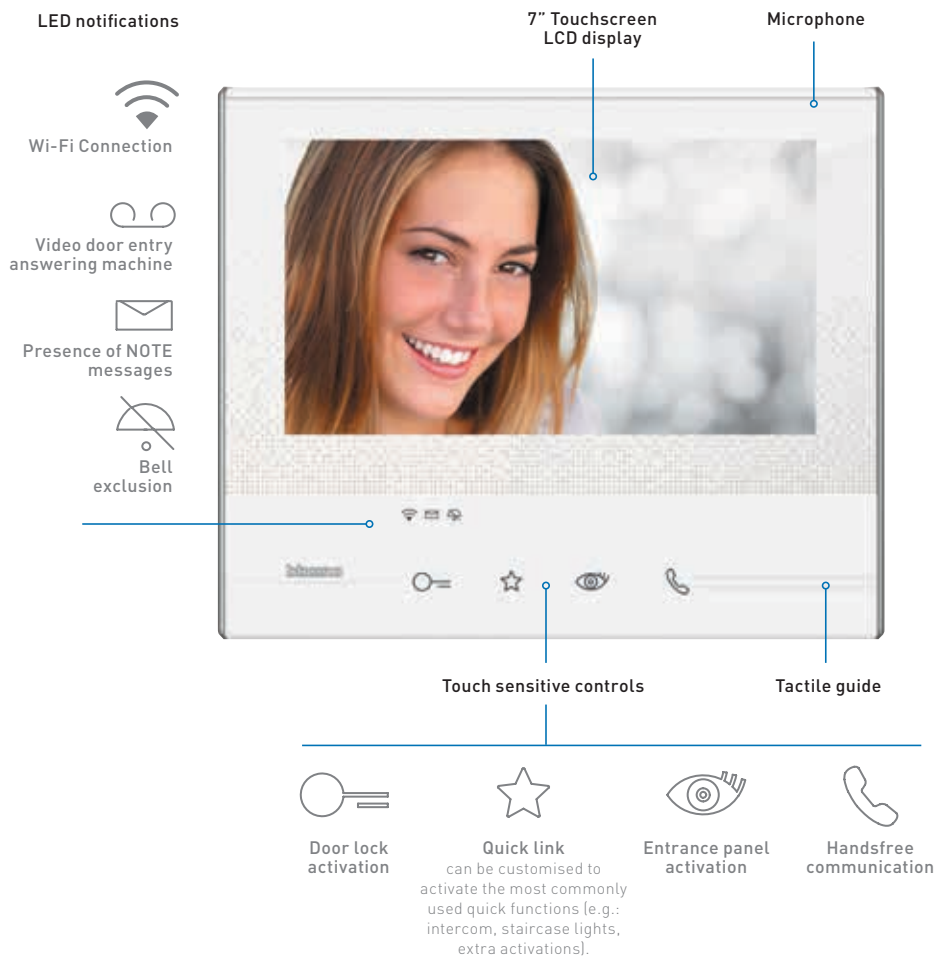

## Rear view

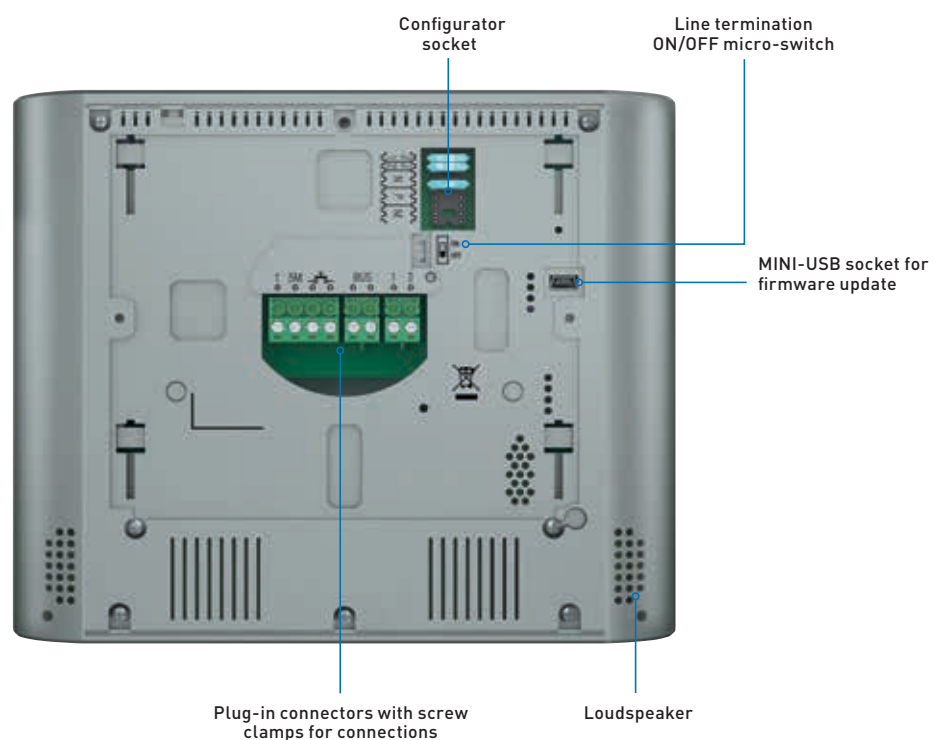

# CLASSE 300

## Catalogue



344642



344643



344612



344613



344622



344632



336803



346020

Item	CLASSE 300X13E HANDSFREE VIDEO INTERNAL UNIT
<b>344642</b>	2 wire/Wi-Fi handsfree video internal unit with inductive loop, 7" Touch Screen LCD display and video door entry answering machine with call audio/video memory – light finish. Capacitive keys for the control of the main video door entry functions: door lock release, handsfree connection, entrance panel activation /camera scrolling and Favorite key (can be configured to activate the quick actions most frequently used - eg: staircase lights control, Intercom, additional activations). Tactile guide for easy access to door lock and handsfree capacitive connection keys. LEDs used for: call exclusion, notification of messages from switchboard and note. Access to adjustments and functions using the touch display. NOTE function - for writing using the keypad, or for voice recording of messages and/or notes for the other residents of the apartment (e.g.: call plumber, do the shopping, etc.). Possibility of voice communication with the switchboard - if present in the system - after a specific call. Wi-Fi connection enables you to associate the videos internal unit to the Door Entry App (available for Andriod and iOS). Management of main video internal unit functions (receiving calls, opening the door lock, activating the entrance panel/cycling and extra activations).
<b>344643</b>	As 344642 but with dark finish.
<b>363911</b>	Handsfree kit with memory, smartphone call redirection, wide angle camera and door lock release key card. Easily expandable up to 2 calls by purchasing an extra internal unit – the pushbutton panel is already set up for 1 or 2 calls.
<b>363611</b>	Handsfree kit with memory, wide angle camera and door lock release key card. Easily expandable up to 2 calls by purchasing an extra internal unit – the pushbutton panel is already set up for 1 or 2 calls.

Item	ACCESSORY FOR TABLE SUPPORT AND CABLE
<b>344632</b>	Accessory support for the table-top installation of the Classe 300 video internal units range.
<b>336803</b>	8-way cable with connector for table-top support connection.

Item	2 DIN ADDITIONAL POWER SUPPLY
<b>346020</b>	Additional 2 DIN power supply to be used to locally supply Classe 300X13E video internal units in multi-family systems.

Item	CLASSE 300V13E HANDSFREE VIDEO INTERNAL UNIT
<b>344612</b>	2 wire / handsfree video internal unit with inductive loop and 7" Touch Screen LCD display – light finish. Capacitive keys for the control of the main video door entry functions: door lock release, handsfree connection, entrance panel activation/camera scrolling and favorite key (can be configured to activate the quick actions most frequently used - eg: staircase lights control, Intercom, additional activations). Tactile guide for easy access to door lock and handsfree capacitive connection keys. LEDs used for: call exclusion, notification of messages from switchboard and note. Access to adjustments and functions using the touch display. NOTE function - for writing using the keypad, or for voice recording of messages and/or notes for the other residents of the apartment (e.g.: call plumber, do the shopping, etc.). Possibility of voice communication with the switchboard - if present in the system - after a specific call.
<b>344613</b>	As 344612 but with dark finish.

Item	CLASSE 300V13M HANDSFREE VIDEO INTERNAL UNIT
<b>344622</b>	2 wire handsfree video internal unit with inductive loop, 7" Touch Screen LCD display and video door entry answering machine with call audio/video memory – light finish. Capacitive keys for the control of the main video door entry functions: door lock release, handsfree connection, entrance panel activation/camera scrolling and favorite key (can be configured to activate the quick actions most frequently used - eg: staircase lights control, Intercom, additional activations). Tactile guide for easy access to door lock and handsfree capacitive connection keys. LEDs used for: call exclusion, notification of messages from switchboard and note. Access to adjustments and functions using the touch display. NOTE function - for writing using the keypad, or for voice recording of messages and/or notes for the other residents of the apartment (e.g.: call plumber, do the shopping, etc.). Possibility of voice communication with the switchboard - if present in the system - after a specific call.

## CLASSE 300

### Dimensional data

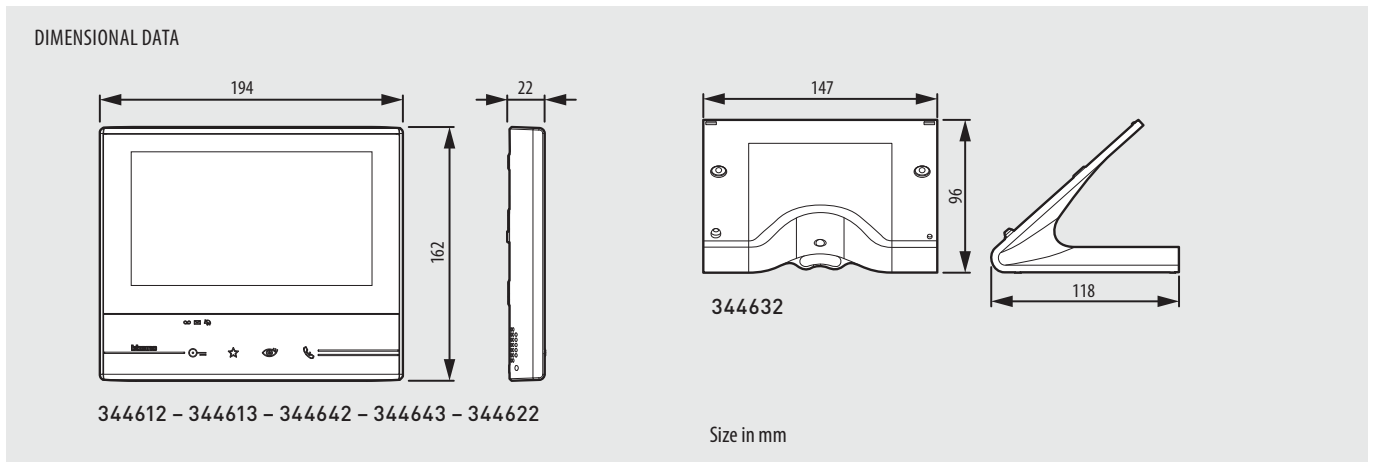

## CLASSE 300

### Also available as a kit



### 363911

Handsfree kit with memory, smartphone call redirection, wide angle camera and door lock release key card. Easily expandable up to 2 calls by purchasing an extra internal unit – the pushbutton panel is already set up for 1 or 2 calls.

### 363611

Handsfree kit with memory, wide angle camera and door lock release key card. Easily expandable up to 2 calls by purchasing an extra internal unit – the pushbutton panel is already set up for 1 or 2 calls.

## CLASSE 300X13E

### Legal notes

To use the video door entry call repeat service on a smartphone, the customer must acquire the technical equipment which allows access to the Internet, on the basis of an agreement made by the customer himself with an ISP (Internet Service Provider). BTicino plays no part in this. The customer must install the Door Entry App on his smartphone so that he can use some services which BTicino supplies as extras to the normal basic functions of the Classe 300X13E video internal unit. The services offered by means of the App require being able to interact with Classe 300X13E remotely and through the Internet. In these cases the integration and good working between Classe 300X13E and App may depend on:

- quality of the Wi-Fi signal
- type of access contract to the home Internet
- type of data contract on the smartphone

When one of these 3 elements does not conform with the specifications required for product operation, BTicino accepts no responsibility for any faults. The product supports a VoIP streaming system. You must therefore check with your smartphone contract – data network – that it does not block it. We should also like to inform you that the service provided by BTicino – remote use via App – involves the use of data. The cost linked to their use depends on the type of contract which the customer has signed with an ISP (Internet Service Provider) and is his responsibility.



Legrand Australia  
Building 4, Nexus Industry Park  
43-47 Lyn Parade, Prestons NSW 2170  
Tel.: 1300 369 777  
[www.legrand.com.au](http://www.legrand.com.au)

HPM Legrand New Zealand  
106-124 Target Road  
Glenfield, Auckland 0627  
Tel.: 0800 476 009  
[www.legrand.co.nz](http://www.legrand.co.nz)

01/2017

HPML1085