

CLASSE 300X13E Touch Screen handsfree video internal units with Wi-Fi

344642
344643

Description

2 WIRE/Wi-Fi handsfree video internal unit with inductive loop, 7" Touch Screen LCD display and video door entry answering machine with call audio/video memory – light and dark finish.

It has capacity keys for the control of the main video door entry functions: door lock release, handsfree connection, entrance panel/scrolling activation and Favorite key (can be configured to activate the quick actions most frequently used - eg: staircase lights control, Intercom, additional activations).

Tactile guide for easy access to door lock and handsfree capacitive connection keys. LEDs used for: call exclusion, notification of messages from switchboard, Wi-Fi and memo. Access to adjustments and functions using the touch display.

MEMO function - for writing using the keypad, or for voice recording of messages and/or notes for the other residents of the apartment (e.g.: call plumber, do the shopping, etc.).

Possibility of voice communication with the switchboard - if present in the system - after a specific call.

The device must be configured by physically connecting the configurators, or using the menu, which will give better possibilities of customisation of associated functions and texts.

Also, thanks to the Wi-Fi connection, you can associate the video internal unit to the Door Entry App (available for Android and iOS). You can manage the main video internal unit functions (receiving calls, opening the door lock, activating the entrance panel/scrolling, FWR updating and additional activations) from the App.

Dimensional data

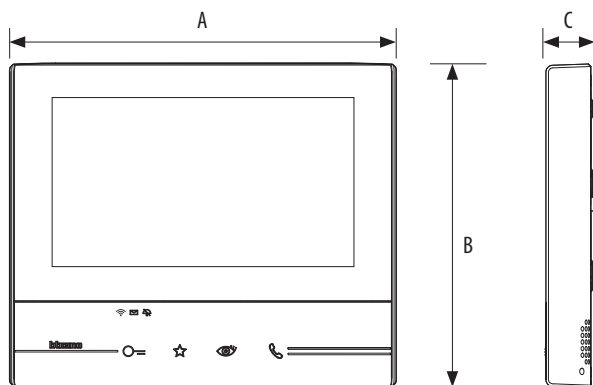

A	B	C
194 mm	162 mm	22 mm

Related items

- 344632 Table-top support.
- 336803 Cable for connection in the table top installation.
- 346020 2 DIN additional power supply.

Technical data

Power supply from SCS BUS:	18 – 27 Vdc
Maximum SCS absorption in Stand by:	110 mA
Maximum SCS absorption in operation:	400 mA
Additional power supply of clamp 1 – 2:	27 Vdc
Maximum absorption from clamp 1 – 2:	250 mA
Operating temperature:	5 – 40 °C

The Classe 300X video internal unit must be connected to a Wi-Fi network with the following features:

- IEEE 802.11 b/g/n (2,4 GHz) 13 channels
- Encrypting and authentication methods supported:
 - OPEN WPA-PSK networks
 - TKIP WPA2-PSK included
 - included AES WEP 64 bits (ASCII 5 figure or hexadecimal 10 figure codes)
 - WEP 128 bits (ASCII 13 figure or hexadecimal 26 figure codes)
 - WPS authentication (supported for WPA2-PSK)

Note:

a domestic Wi-Fi with internet access is needed for the connection between the Classe300X13E video internal unit and the smartphone.

To use the service, the Customer must acquire the technical equipment which allows access to the Internet, on the basis of an agreement made by the Customer himself with an ISP (Internet Service Provider). BTicino plays no part in this.

The Customer must install the App on his smartphone so that he can use some services which BTicino supplies as extras to the normal basic functions of the Classe300X13E.

The services offered by means of the APP require being able to interact with Classe300X13E remotely and through the Internet.

In these cases the integration and good working between Classe300X13E and APP may depend on:

- quality of the Wi-Fi signal
- type of access contract to the home Internet
- type of data contract on the smartphone

When one of these 3 elements does not conform with the specifications required for product operation, BTicino accepts no responsibility for any faults.

The product in fact supports a VoIP streaming system. You must therefore check with your smartphone data network contract that it does not block it.

We would like to inform you that the service provided by BTicino by means of remote use via the APP involves the use of data. The cost linked to data usage depends on the type of contract which the customer has with his ISP (Internet Service Provider) and is solely the customer's responsibility.

Legend

Front view

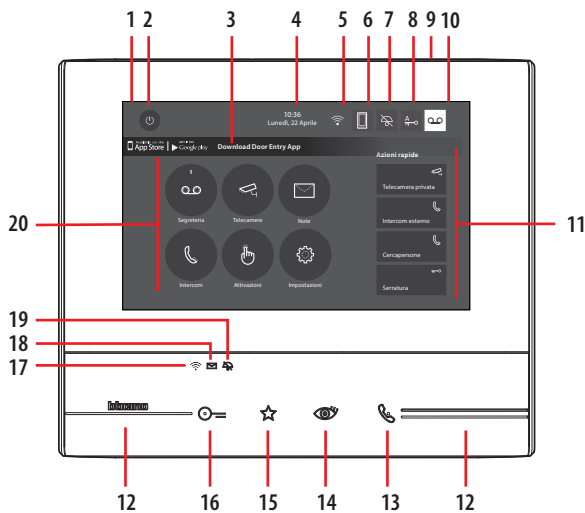

Rear view

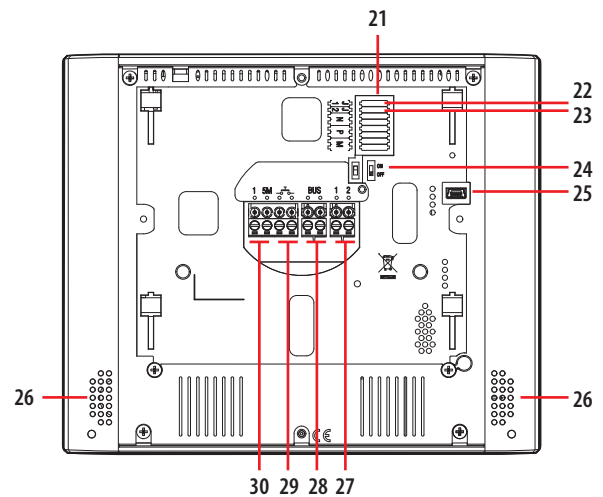

Nota: the image* shows the device with all its functions enabled. Check on the Installer Manual how to enable the functions.

*The background and icons shown may differ from those on the device.

- | | |
|---|---|
| <ol style="list-style-type: none"> 1. 17" (Touch Screen) display 2. OFF key 3. App:
touch to display the information page where you find a QR code that allows the download of the DOOR ENTRY app to interact with your device 4. Date and time 5. Wi-Fi Connection 6. Device/app association and enabled/disabled forwarding of call 7. Bell exclusion 8. Office activation 9. Microphone 10. Answering machine activation 11. Quick actions 12. Tactile guides for the blinds 13. Connection key:
The green LED flashes to indicate an incoming call
The green LED comes on steady to indicate that there is an active call 14. Auto-switching on/Cycling:
The red LED turns on when the key is pressed 15. Favorites Key:
The red LED turns on when the key is pressed
(Basic configuration = STAIRCASE LIGHT. For a different configuration refer to the physical configuration table in the following pages.) 16. Door lock release key
The red LED turns on when the key is pressed | <ol style="list-style-type: none"> 17. Wi-Fi Status:
Red LED flashing = Wi-Fi is active but not connected to a network
LED off = disabled or properly functioning Wi-Fi
Green LED steady = the Classe 300X is exchanging data with the DOOR ENTRY app (forwarding of call, auto-switching on) 18. Message status:
Red LED flashing = new unread note/s or message/s in the answering machine 19. Bell exclusion Status:
Red LED on = Call bell disabled 20. Functions (only the icons for the configured functions are displayed) 21. Configurator seat (See "Configurator Functions") 22. Configurator J1: remove if the additional power supply is present (clamp 1 and 2) 23. J2 configurator: for correct operation do not remove 24. Line termination ON/OFF micro-switch 25. Mini USB socket for device Firmware update 26. Loudspeaker 27. Additional power supply clamps (1 - 2) 28. 2 WIRE SCS/BUS connection clamps 29. Clamps (—) for the connection of an external call to the floor pushbutton 30. Additional bell connection clamps (1 - 5M) Point-to-Point connections are required on the clamps of the additional bells. |
|---|---|

Note: When the DOOR ENTRY is connected to the system (e.g. answer a call, display an Entrance Panel, etc.), no operations can be made, with the exception of the door lock release key and Favorite Key (configured for the Staircase Light or Door Lock Direct Control functions) that continue to operate.

Configuration

The device can be configured in two different ways:

- **Physical configuration** (with physical configurator connection)
- **Advanced configuration** using the appropriate configuration section on the device.

The **physical configuration** gives the user the possibility of accessing to the menu with video door entry functions. It is the classic configuration with configurators to connect physically to the appropriate sockets on the back of the device.

WARNING: the configuration of the device completed using configurators **CANNOT BE MODIFIED** using the menu.

J1	J2	N	P	M
⊙	⊙	⊙	⊙	⊙
⊙	⊙	⊙	⊙	⊙

N - handset number

The configurators connected to the N sockets of the device assign an identification number within the system to each video handset. The handsets must be configured in progressive order. The handsets must be configured in progressive order. Handsets with parallel connection (max 3 are allowed inside apartments without item 346850) must be configured using the same N configurator. In parallel with the main video handset, additional handsets, video handsets and/or bells may be installed.

P – entrance panel association

The configurators connected to the P sockets of the device identify the associated EP, which is the first entrance panel that switches itself on when the pushbutton is pressed the first time, as well as which door lock is activated when pressing the door lock pushbutton while the video handset is idle.

M – modalità di funzionamento

The configurators are connected to the M sockets of the device, assigning the operating mode to the Favorites key (★) and to the Quick Actions shown on the display.

J1 – additional power supply

The JMP configurator in J1 is used to enable/disable the additional power supply according to the following mode:

- J1 CONNECTED = Additional power supply disabled
- J1 DISCONNECTED = Additional power supply enabled

J2 - For correct operation do not remove

The **advanced configuration** has the advantage of offering many more options when compared with the physical configuration.

Connection to the PC

To update the firmware, connect the device to the PC using a USB-miniUSB cable. Note: the video internal unit can also be updated via the DOOR ENTRY APP, downloading the new firmware directly from the cloud. This procedure is only possible after the CLASSE300X13E has been connected to a LAN (with Internet access) and associating a smartphone.

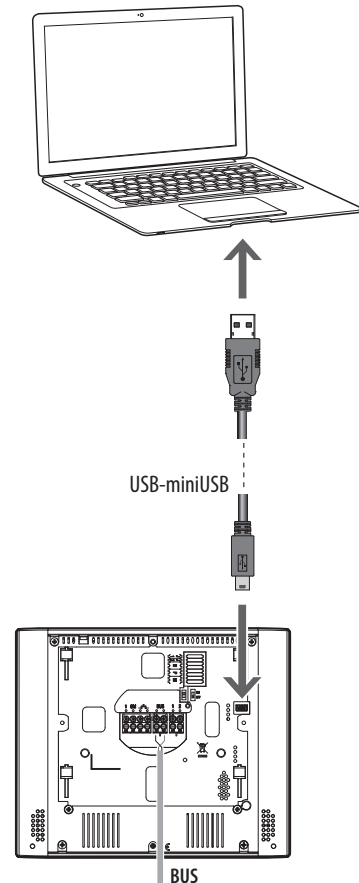

To ensure that the communication is successful, the video internal unit must be powered.

The functions that can be attributed to the Favorite key (☆) using the physical procedure, using the configurator inserted in the MM-(units) socket are the following:

J1	J2	N	P	M
○	○	○	○	○
○	○	○	○	○

MM =	Staircase Light Control	
MM =	Direct control of (P+1) door lock	
MM =	Direct control of (P+2) door lock.	
MM =	Direct control of (P+3) door lock.	
MM =	(P+1) direct auto-switching on.	
MM =	(P+2) direct auto-switching on.	
MM =	(P+3) direct auto-switching on.	
MM =	Paging.	
MM =	Internal intercom.	
MM =	Enabling/disabling Professional Studio function.	

The MM - (tenths) physical configurator decides which are the 4 QUICK ACTIONS icons that appear on the HOME PAGE, and can be activated by touching the display.

J1	J2	N	P	M
○	○	○	○	○
○	○	○	○	○

















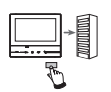

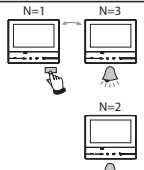
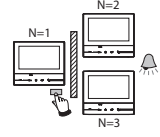
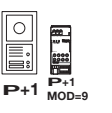
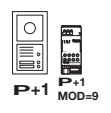
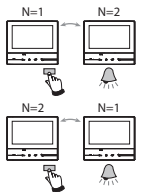
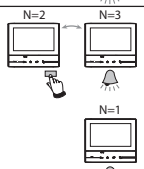
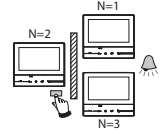

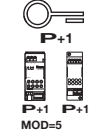
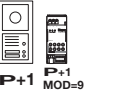
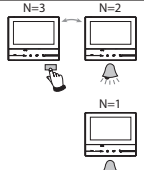
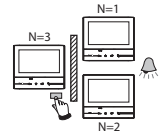
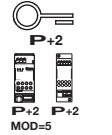
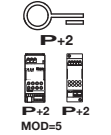
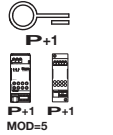
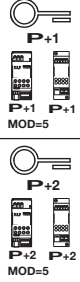





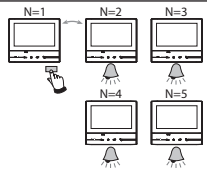
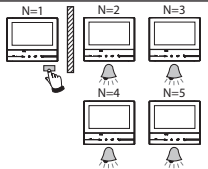

The possible configurations are shown in the table of the following page.

LEGEND

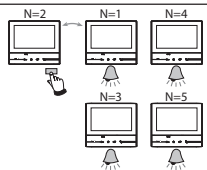
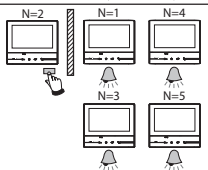
	1 Activation of the EP (configured with P+1) directly without call or activation of the actuator item 346200/346210 (configured with P+1 and MOD=9).
	EP door lock release (configured with P+1), directly without call, or activation of the actuator item 346200/346210 (configured with P+1 and MOD=5), or activation of door lock actuators item 346230 (configured with P+1).
	EP door lock release (configured with P+2), directly without call, or activation of the actuator item 346200/346210 (configured with P+2 and MOD=5), or activation of door lock actuators item 346230 (configured with P+2).
	EP door lock release (configured with P+3), directly without call, or activation of the actuator item 346200/346210 (configured with P+3 and MOD=5), or activation of door lock actuators item 346230 (configured with P+3).
	EP door lock release (configured with P+4), directly without call, or activation of the actuator item 346200/346210 (configured with P+4 and MOD=5), or activation of door lock actuators item 346230 (configured with P+4).
	Intercom among apartments in systems with apartment interface item 346850.
	Intercom inside the apartment, in systems with apartment interface item 346850, or intercom among apartments in systems without apartment interface.
	Internal intercom. It sends the call to all the handsets with the same address.
	Paging, it makes general intercom and sends a call to all the handsets of the system.

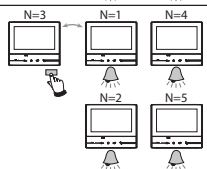
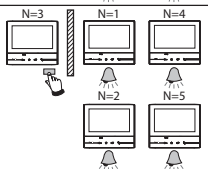

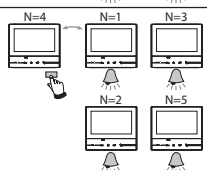
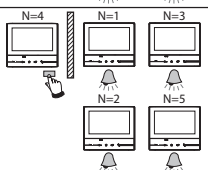

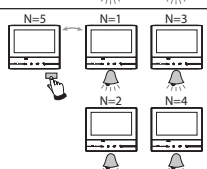
CLASSE 300X13E
Touch Screen handsfree video internal units
with Wi-Fi

344642
344643

MM = 	MM = 	MM = 	MM = 	MM = 
				
				
				
				
				
				
				
				
MM = 	MM = 	MM = 	MM = 	
				
				
				
				
				

Main functions

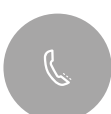
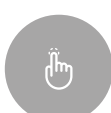
The main screen of the device shows the icons of the main functions configured. The following tables describe the functions available:

Icon	Function	Meaning
	Answering machine	Touch to access the screen with one or more audio/video messages to be heard.
	Cameras	Touch to access the screen for the activation of the cameras of the system, and display the images recorded by them.
	Notes	Touch to access the screen used to write or record a notes, or display and listen to any notes present.
	Intercom	Touch to access the screen used communicated with other audio/video internal units installed in your apartment or in other apartments.
	Activations	Touch to access the screen where it is possible to enable certain actuators (e.g. door locks, garden light, etc.).
	Settings	Touch to access the screen where it is possible to customise the functions, to make the most of your device.

The video handset offers the possibility to select among 16 types of bells with programmed ringtones, which can be freely associated to the following type of calls:

- Call from the entrance panel (configured with S=0)
- Call from the entrance panel (configured with S=1)
- Call from the entrance panel (configured with S=2)
- Call from the entrance panel (configured with S=3)
- Intercom call within the apartment
- Intercom call outside the apartment
- Floor call
- Notification

The association of the type of ringtone to the event is performed using the dedicated menu on the device.

Using the advanced configuration, the video handset gives the possibility of programming up to:

- 50 generic activations
- 50 direct activations to the door locks
- 40 intercoms within the apartment
- 40 intercoms outside the apartment
- 50 direct auto-switching on to the EP

It is also possible to record, and/or enter, local NOTES, up to a maximum of:

- Audio notes: 20
- Text notes: 50

When this limit is reached, older notes will be replaced by new ones.

DOOR STATUS function

This function notifies the status of the door lock. If open the "LED door lock" of the handset flashes, and if closed, the LED stays off. **WARNING:** the function can only be activated if required by the system - accessory devices are required. **CANNOT BE ACTIVATED** together with the PROFESSIONAL STUDIO (OFFICE) function.

PROFESSIONAL STUDIO (OFFICE) function

When preset using the appropriate configuration, the PROFESSIONAL STUDIO (OFFICE) function appears on the menu and can be enabled/disabled with the Favorite key (☆) or with the dedicated icon. With the function active, when a call is received from the entrance panel, the video handset rings and the associated door lock is automatically activated, without the need for pressing the door lock control key of the device.

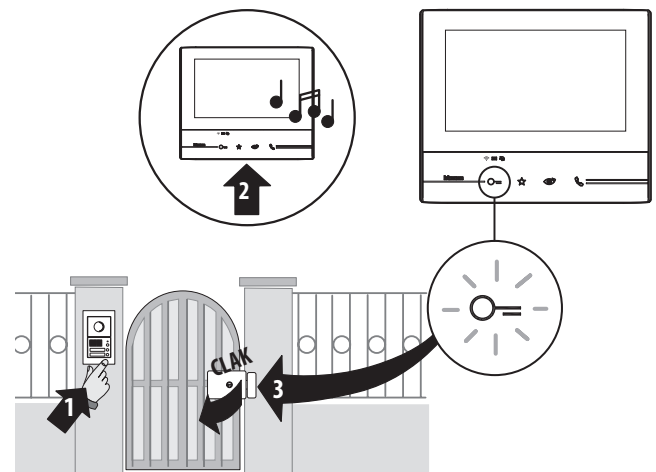

PAGING function

This function, if preset by an appropriate configuration, can be used to send voice messages using the microphone of the device through the speakers of the sound system. The activation is performed by clicking the dedicated icon on the display. The green LED on, and the message on the display, indicate that the function is active. To **DISABLE** the function press the "Connection" key again.

INDUCTIVE LOOP use

The inductive loop function enables the device to be used by people wearing hearing aids with (T) selector. Switch the acoustic device to the T position. To ensure correct magnetic coupling between the handset and the acoustic device, we recommend a position in front of the device, at a distance of 25 – 35 cm.

NOTE: the presence of metal and background noise generated by electric/electronic devices (e.g. computer) may compromise the performance and the quality of the coupling device.

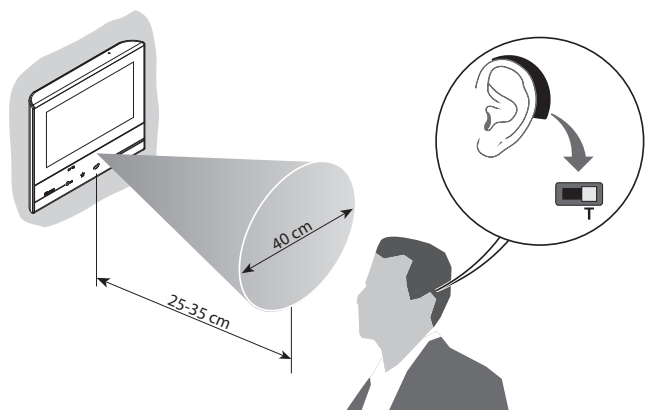

Maximum distances and cable features

Systems made with traditional internal units only.

MAXIMUM LINE A DISTANCE, ENTRANCE PANEL - FURTHEST HANDSET

Cable section mm ²	2 normal cables > 0.2 mm ²	BTicino cable 336904 0.5 mm ²	Telephone twisted pair 0.28 mm ²	A pair of the multi- pair data cable CAT5
2 IU/2 pushbuttons	50 m	200 m	140 m	180 m
5 IU/5 pushbuttons	50 m	200 m	140 m	155 m
10 IU/10 pushbuttons	50 m	200 m	140 m	145 m
26 IU/26 pushbuttons	50 m	200 m	140 m	125 m
38 IU/38 pushbuttons	50 m	200 m	140 m	110 m
38 IU/38 pushbuttons with local power supply	50 m	200 m	140 m	170 m
38 IU/digital call modules	50 m	200 m	140 m	115 m
64 IU/digital call modules	50 m	200 m	140 m	-

MAXIMUM LINE C DISTANCE, POWER SUPPLY - FURTHEST HANDSET

Cable section mm ²	2 normal cables > 0.2 mm ²	BTicino cable 336904 0.5 mm ²	Telephone twisted pair 0.28 mm ²	A pair of the multi- pair data cable CAT5
2 IU in/out	50 m	200 m	130 m*	90 m*
5 IU in/out	50 m	200 m	130 m	90 m
10 IU in/out	50 m	190 m	120 m	80 m
26 IU in/out	50 m	170 m	110 m	70 m
5 HA (shunted)	50 m	200 m	110 m	80 m
10 HA (shunted)	50 m	160 m	100 m	70 m
26 HA (shunted)	50 m	130 m	80 m	60 m
38 HA (shunted)	50 m	110 m	70 m	50 m
64 HA (shunted)	+	85 m	55 m	-

MAXIMUM LINE B DISTANCE, ENTRANCE PANEL - POWER SUPPLY

Cable section mm ²	2 normal cables > 0.2 mm ² o L4669	BTicino cable 336904 0.5 mm ²	telephone twisted pair 0.28 mm ²	a pair of the multi- pair data cable CAT5
2 pushbuttons	50 m	200 m	115 m	90 m
10 pushbuttons	50 m	170 m	100 m	75 m
26 pushbuttons	50 m	150 m	95 m	65 m
38 pushbuttons	50 m	140 m	90 m	60 m
≥ 38 pushbuttons with local power supply	50 m	200 m	140 m	120 m
digital call	50 m	150 m	95 m	65 m

MAXIMUM LINE D DISTANCE ENTRANCE PANEL - DOOR LOCK

Cable section mm ²	0.28 mm ²	BTicino ca- ble L4669 0.35 mm ²	BTicino cable 336904 0.5 mm ²	1 mm ²
S+ S- clamps	30 m	30 m	50 m	100 m

Systems made with at least one advanced internal unit.

MAXIMUM LINE A DISTANCE, ENTRANCE PANEL - FURTHEST HANDSET

Cable section mm ²	2 normal cables > 0.2 mm ²	BTicino cable 336904 0.5 mm ²	Telephone twisted pair 0.28 mm ²	A pair of the multi- pair data cable CAT5
2 IU/2 pushbuttons	50 m	200 m	140 m	145 m
5 IU/5 pushbuttons	50 m	200 m	140 m	135 m
10 IU/10 pushbuttons	50 m	200 m	140 m	130 m
26 IU/26 pushbuttons	50 m	200 m	140 m	105 m
38 IU/38 pushbuttons	50 m	200 m	140 m	95 m
38 IU/38 pushbuttons with local power supply	50 m	200 m	140 m	155 m
38 IU/digital call modules	50 m	200 m	140 m	90 m

MAXIMUM LINE C DISTANCE, POWER SUPPLY - FURTHEST HANDSET

Cable section mm ²	2 normal cables > 0.2 mm ²	BTicino cable 336904 0.5 mm ²	Telephone twisted pair 0.28 mm ²	A pair of the multi- pair data cable CAT5
2 IU in/out	50 m	150 m	100 m	65 m
5 IU in/out	50 m	140 m	90 m	60 m
10 IU in/out	50 m	130 m	80 m	60 m
26 IU in/out	50 m	110 m	70 m	50 m
5 HA (shunted)	50 m	140 m	90 m	60 m
10 HA (shunted)	50 m	120 m	80 m	55 m
26 HA (shunted)	50 m	95 m	60 m	40 m
38 HA (shunted)	50 m	80 m	50 m	35 m

MAXIMUM LINE B DISTANCE, ENTRANCE PANEL - POWER SUPPLY

Cable section mm ²	2 normal cables > 0.2 mm ² o L4669	BTicino cable 336904 0.5 mm ²	telephone twisted pair 0.28 mm ²	a pair of the multi- pair data cable CAT5
2 pushbuttons	50 m	200 m	115 m	90 m
10 pushbuttons	50 m	170 m	100 m	75 m
26 pushbuttons	50 m	150 m	95 m	65 m
38 pushbuttons	50 m	140 m	90 m	60 m
≥ 38 pushbuttons with local power supply	50 m	200 m	140 m	120 m
digital call	50 m	150 m	95 m	65 m

MAXIMUM LINE D DISTANCE ENTRANCE PANEL - DOOR LOCK

Cable section mm ²	0.28 mm ²	BTicino cable L4669 0.35 mm ²	BTicino ca- ble 336904 0.5 mm ²	1 mm ²
S+ S- clamps	30 m	30 m	50 m	100 m

If all the "advanced" internal units in the system are supplied locally the system should be considered as being made with "traditional" internal units only.
 Risers with max 26 IU should be made in systems with more than 26 internal units.

Wiring diagrams

Below are some examples of connection of the CLASSE 300X13E (344642 - 344643) video handset in multi-family 2 wire video door entry systems.

DIAGRAM 1 - EXAMPLE OF MULTI-FAMILY SYSTEM WITH POWER SUPPLY

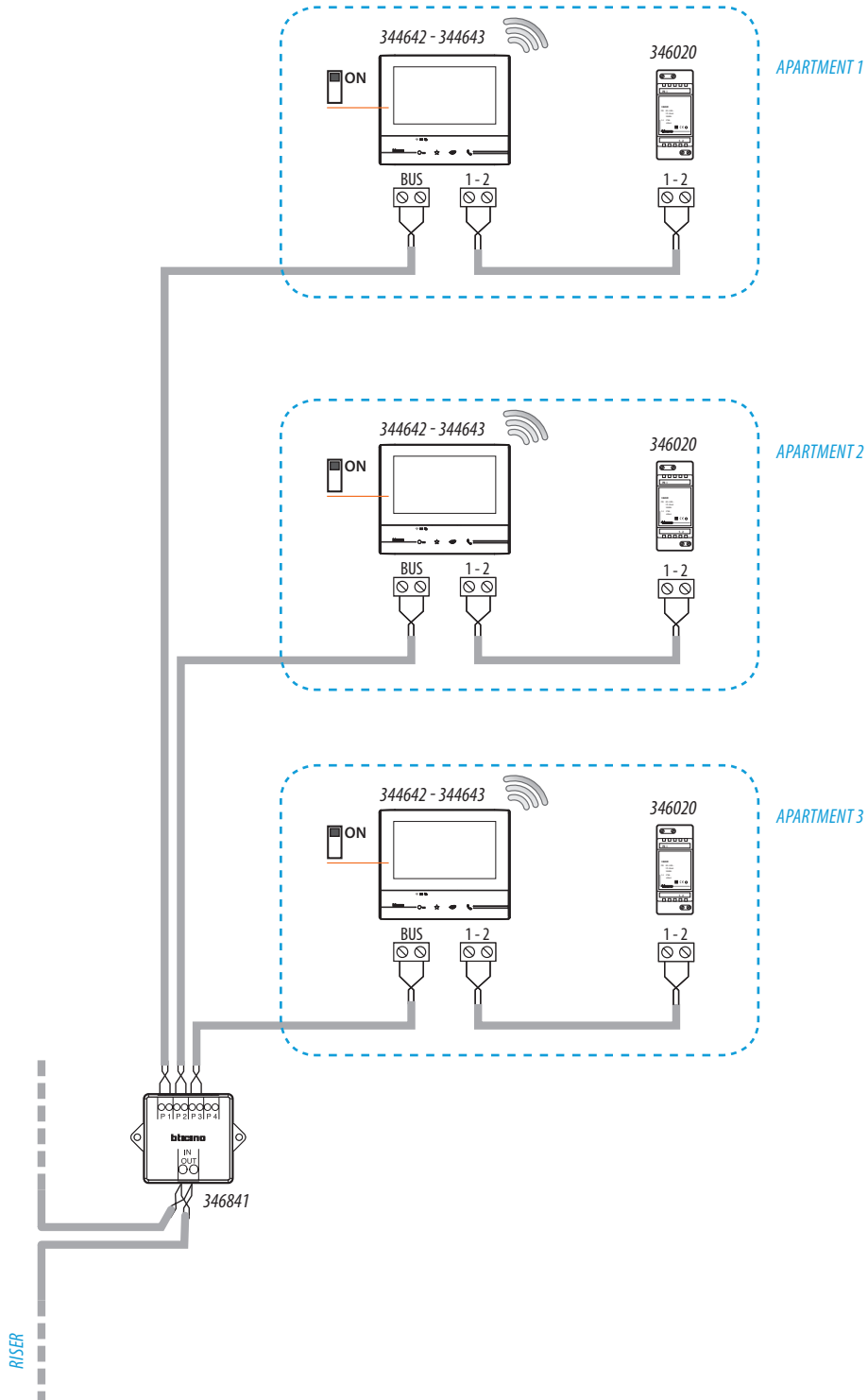

Note:

- additional powersupply is mandatory;
- only one classe 300X13E in the local lan;
- classe 300X13E has to be installed only in installation tottally 2wire technology.

Wiring diagrams

DIAGRAM 2 - EXAMPLE OF MULTI-FAMILY SYSTEM WITH ADDITIONAL INTERNAL UNITS AND POWER SUPPLY

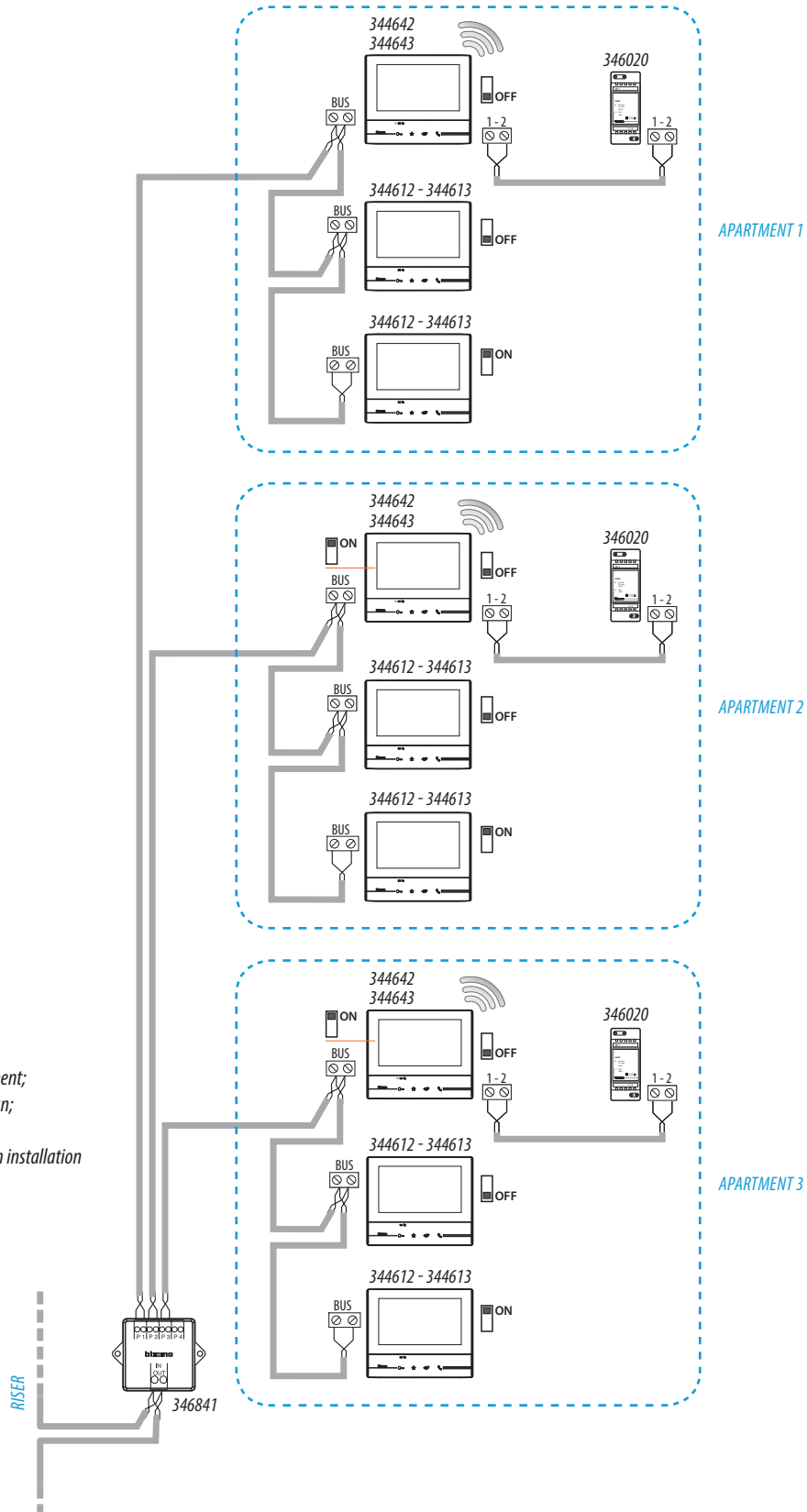

Note:

- additional powersupply is mandatory;
- only one classe 300X13E in every apartment;
- only one classe 300X13E in every local lan;
- max 3 internal unit for apartment;
- classe 300X13E has to be installed only in installation tottally 2wire technology.

Wiring diagrams

DIAGRAM 3 – EXAMPLE OF A MULTI-FAMILY SYSTEM WITH ADDITIONAL INTERNAL UNITS, WITHOUT ADDITIONAL POWER SUPPLY AND WITH AUDIO/VIDEO NODE

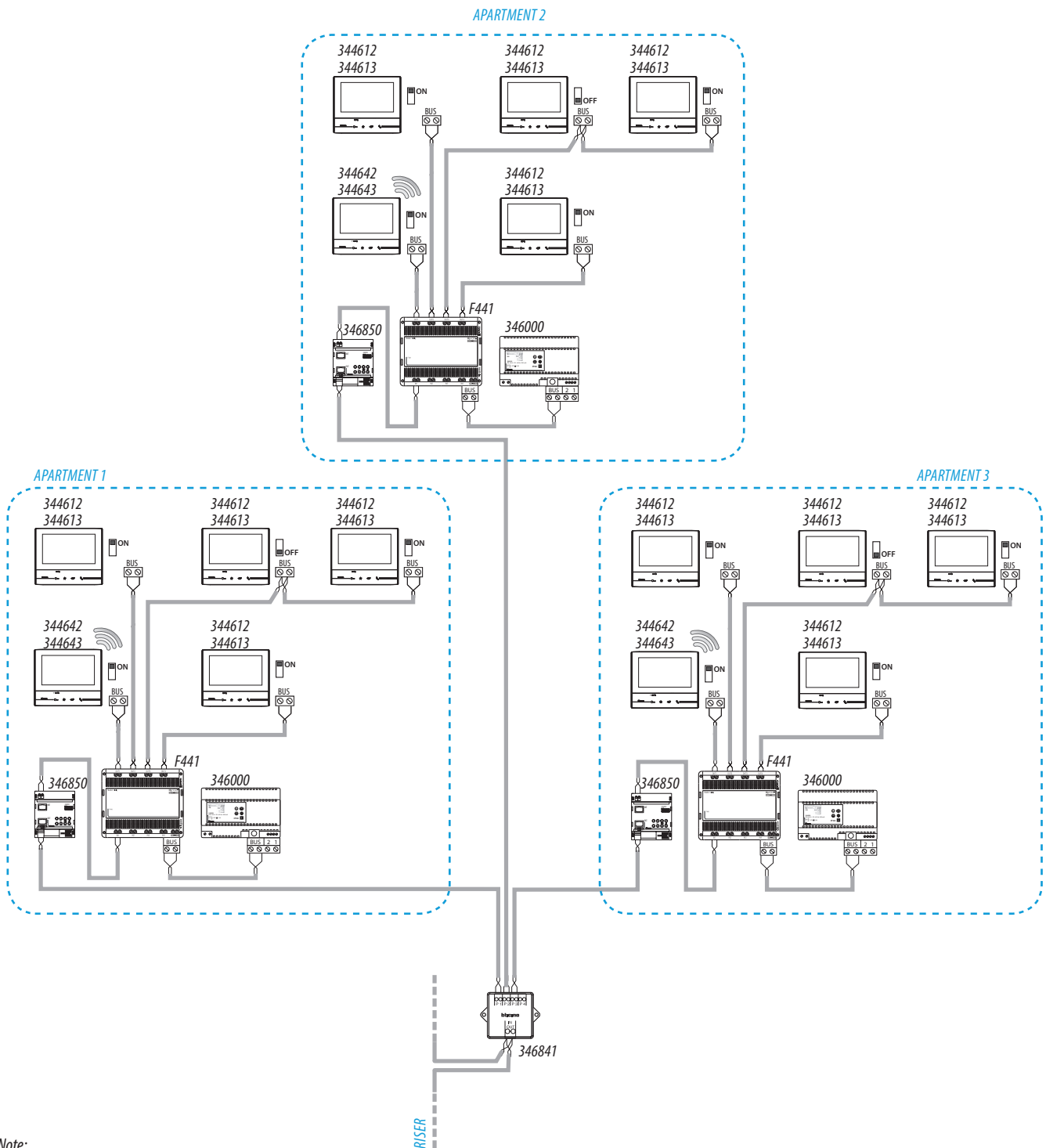

Note:

- additional powersupply is not necessary;
- only one classe 300X13E in every apartment;
- only one classe 300X13E in every local lan;
- max 5 internal units for apartment;
- classe 300X13E has to be installed only in installation tottally 2wire technology.

Wiring diagrams

DIAGRAM 4 - EXAMPLE OF SINGLE-FAMILY DIAGRAM

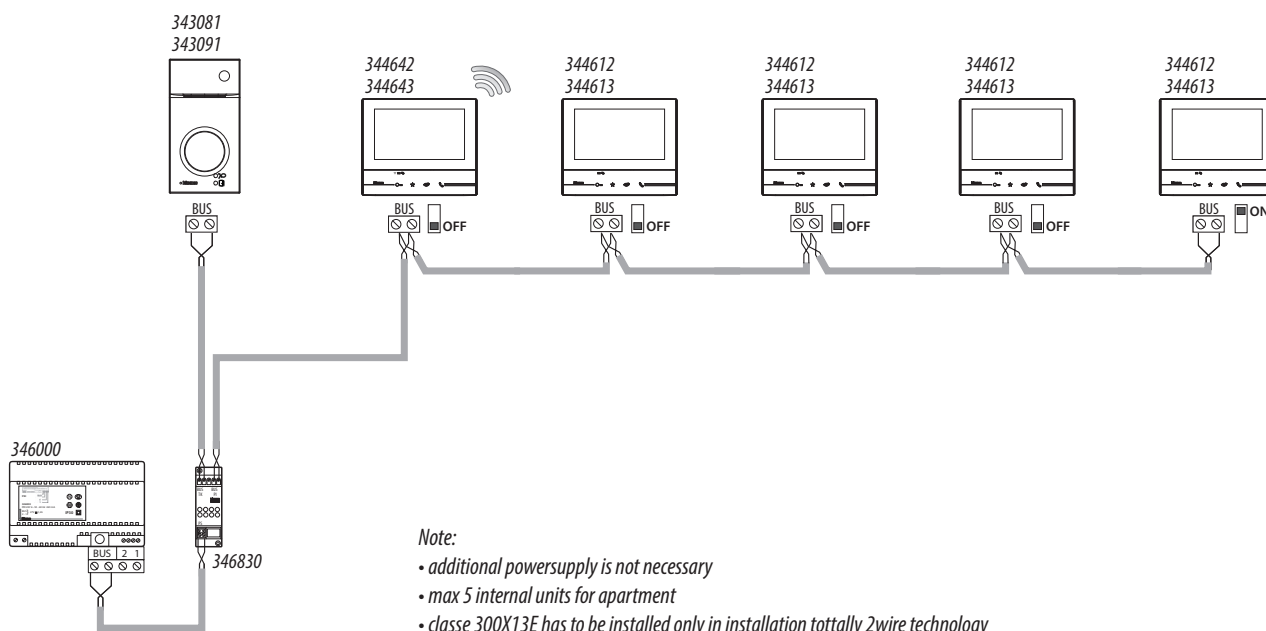
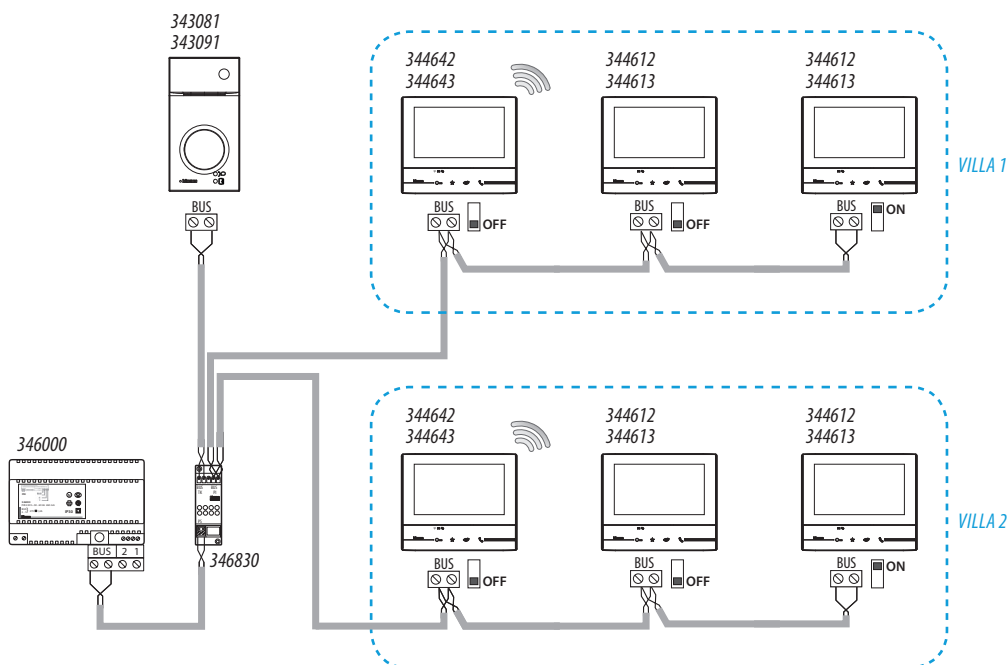

DIAGRAM 5 - EXAMPLE OF TWO-FAMILY DIAGRAM



- Note:*
- additional powersupply is not necessary;
 - only one classe 300X13E in every apartment;
 - only one classe 300X13E in every local lan;
 - max 3 internal units for apartment;
 - classe 300X13E has to be installed only in installation tottally 2wire technology.