

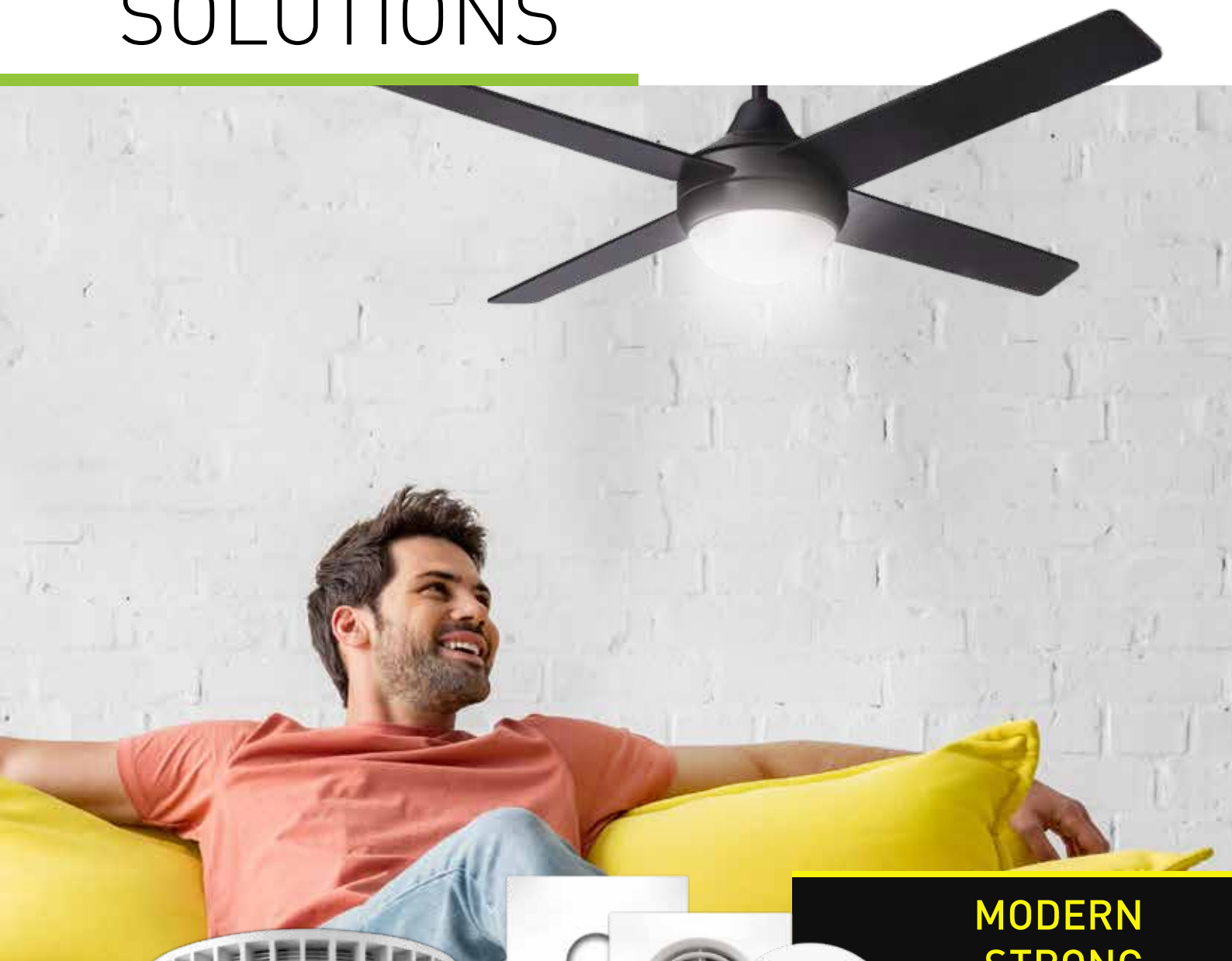

A brand of  legrand®

VENTILATION SOLUTIONS



**MODERN
STRONG
RELIABLE**

2021/2022



CONTENTS

WHY IS VENTILATION SO IMPORTANT?	4
EXHAUST FANS	6
FAN REGULATIONS	8
CHOOSING THE RIGHT EXHAUST FAN	10
FAN PLACEMENT	14
FAN INSTALLATION	15
WET AREA RECOMMENDATIONS & TIPS	17
WALL EXHAUST FAN 100MM NON-DUCTED	18
WALL EXHAUST FAN 150MM NON-DUCTED	20
WALL EXHAUST FAN 150MM AUTO-SHUTTER NON-DUCTED	22
CEILING EXHAUST FAN 200MM NON-DUCTED	24
CEILING EXHAUST FAN 250MM NON-DUCTED	26
CEILING EXHAUST FAN 150MM DUCTED	28
IN-LINE EXHAUST FAN KIT DUCTED	30
ACCESSORIES	32
RANGE OVERVIEW	34
INSTANT HEAT	36
INSTANT HEAT SINGLE LAMP NON-DUCTED	38
INSTANT HEAT 3-IN-1 NON-DUCTED 2 LAMPS	40
INSTANT HEAT 3-IN-1 NON-DUCTED 4 LAMPS	42
INSTANT HEAT 3-IN-1 DUCTED 2 LAMPS	44
INSTANT HEAT 3-IN-1 DUCTED 4 LAMPS	46
POSITIONING OF AN INSTANT HEAT & TIPS	48
RANGE OVERVIEW	49
CEILING SWEEP FAN	50
CLASSIC STREAMLINE DESIGN	52
FEATURES OVERVIEW	54
INSPIRE RESIDENTIAL SWEEP	56
INSPIRE RESIDENTIAL SWEEP WITH LIGHT	58
INSPIRE SMART SWEEP WITH LIGHT	60
WHITE ALUMINIUM SERIES	62
430 STAINLESS STEEL SERIES	64
ACCESSORIES	66
RANGE OVERVIEW	67

WHY VENTILATION IS SO IMPORTANT

It is important to understand what contributes to poor indoor air quality and the potential affects and harm that can be caused by poor ventilation in a home. Poor ventilation can cause a number of problems such as condensation, mould, allergies, dust mites and air pollutants (odours). These can potentially lead to structural building issues and health problems for residents. A properly ventilated home can create a safe, comfortable and healthier environment.



MOISTURE that is not properly ventilated can cause mildew and mould formation, which can potentially lead to structural and health problems. Exhaust ventilation solutions from HPM remove humidity at the source to help maintain the optimal humidity balance of 40 to 60 percent.



OFF-GASSING from construction materials, carpeting, adhesives and synthetic materials—as well as solvents from common household cleaners—can accumulate in tightly built homes.



PARTICULATES from dust, allergens, pet dander, and more can contribute to poor indoor air quality. This can lead to 100 times dirtier air than the air outside. With a properly ventilated home, you create a more enjoyable, comfortable, and healthier environment.



COOKING EFFLUENTS from food preparation can infiltrate the whole house in minutes. Grease, oils and aromas settle permanently into carpets, furniture, clothing and other surfaces. Kitchen ventilation solutions help eliminate cooking effluents for a cleaner, more comfortable and healthier environment.

VENTILATION SOLUTIONS FOR EVERY ROOM

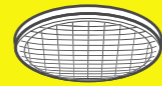
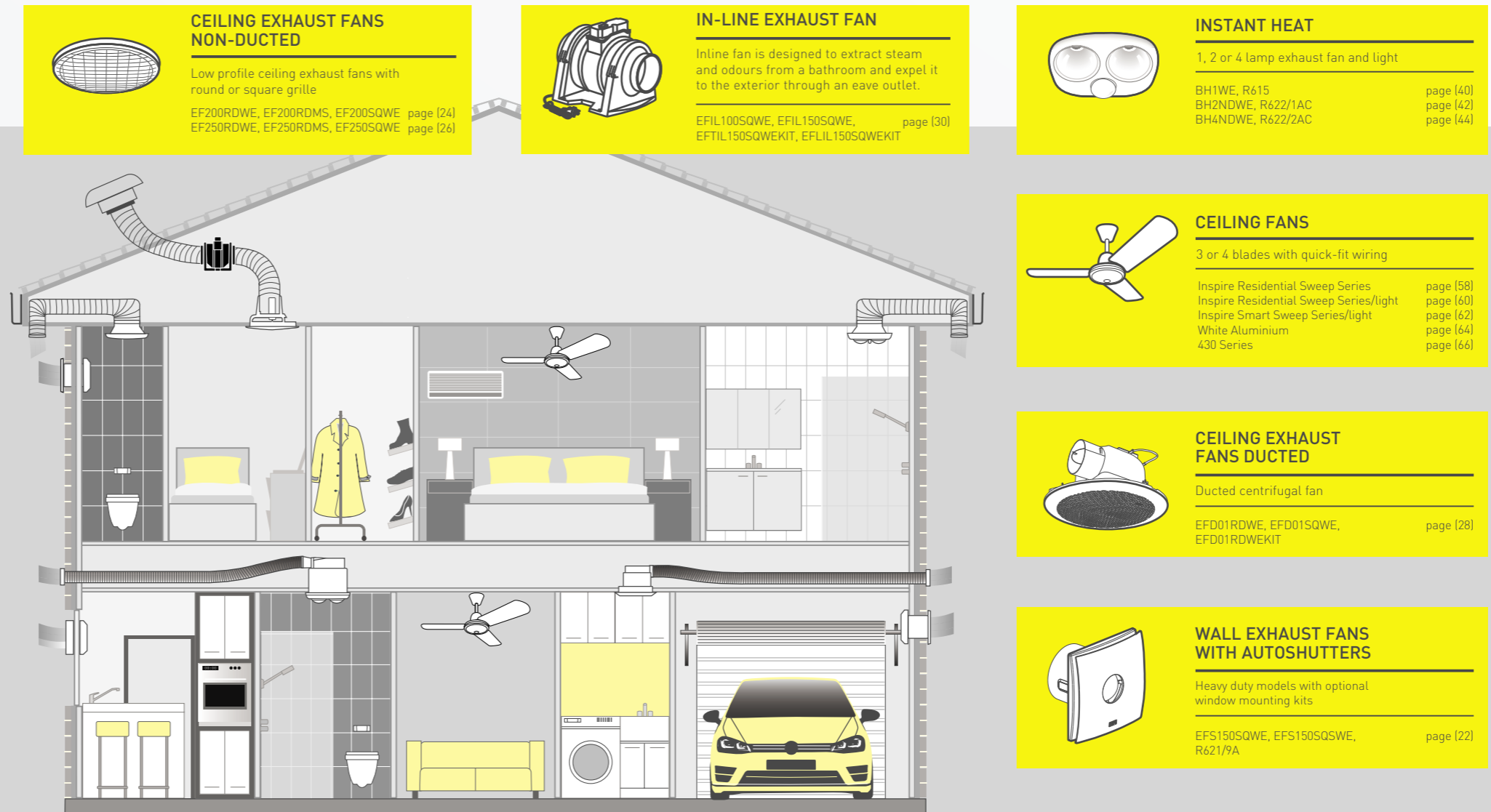

CEILING EXHAUST FANS NON-DUCTED

Low profile ceiling exhaust fans with round or square grille
 EF200RDWE, EF200RDMS, EF200SQWE page (24)
 EF250RDWE, EF250RDMS, EF250SQWE page (26)



IN-LINE EXHAUST FAN

In-line fan is designed to extract steam and odours from a bathroom and expel it to the exterior through an eave outlet.
 EFIL100SQWE, EFIL150SQWE, page (30)
 EFTIL150SQWEKIT, EFLIL150SQWEKIT



INSTANT HEAT

1, 2 or 4 lamp exhaust fan and light
 BH1WE, R615 page (40)
 BH2NDWE, R622/1AC page (42)
 BH4NDWE, R622/2AC page (44)



WALL EXHAUST FANS 100MM

With or without time delay optional mounting kits for ducting through walls
 EF100SQWE, EFT100SQSWE, page (19)
 EF100SQSWEKIT, EF100RDWE,
 EF100SQSWE

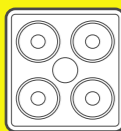

INSTANT HEAT – DUCTED

2 or 4 lamp ducted centrifugal exhaust fans and light
 BH2DWE, R622D1 page (46)
 R622D2, BH4DWE page (48)

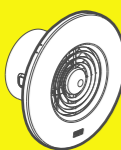

WALL/CEILING EXHAUST FANS 150MM

Heavy duty models with optional window mounting kits
 EF150SQWE, EF150SQSWE, EF150RDWE, page (20)
 R621/8A, EFT150SQSWE, EFH150SQSWE

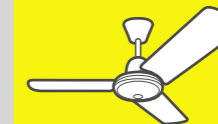

CEILING FANS

3 or 4 blades with quick-fit wiring
 Inspire Residential Sweep Series page (58)
 Inspire Residential Sweep Series/light page (60)
 Inspire Smart Sweep Series/light page (62)
 White Aluminium page (64)
 430 Series page (66)

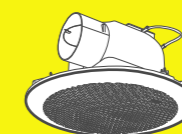

CEILING EXHAUST FANS DUCTED

Ducted centrifugal fan
 EFD01RDWE, EFD01SQWE, page (28)
 EFD01RDWEKIT

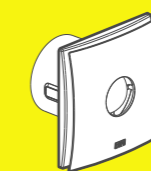

WALL EXHAUST FANS WITH AUTOSHUTTERS

Heavy duty models with optional window mounting kits
 EFS150SQWE, EFS150SQSWE, page (22)
 R621/9A



EXHAUST FANS

NEW FAN REGULATIONS

FLOW RATE AND DISCHARGE OF EXHAUST SYSTEMS



BATHROOMS

The regulations require a fan capable of a minimum extraction capacity of **25 litres per second** when installed.



KITCHENS

The regulations require a fan capable of a minimum extraction capacity of **40 litres per second** when installed.



TOILETS

The regulations require a fan capable of a minimum extraction capacity of **25 litres per second** when installed.



LAUNDRIES

The regulations require a fan capable of a minimum extraction capacity of **40 litres per second** when installed.

VENTILATION OF ROOF SPACES



The roof space must be ventilated to outdoor air through evenly distributed openings, if the exhaust fans discharge into the roof space.

WHAT IS THE NCC



The **National Construction Code (NCC)** provides the minimum necessary requirements for safety and health; amenity and accessibility, and sustainability in the design, construction, performance and livability of new buildings (and new building work in existing buildings) throughout Australia. It is a uniform set of technical provisions for building work, plumbing and drainage installations throughout Australia, whilst allowing for variations in climate, geological or geographic conditions.

WHY THE NCC 2019 COMPLIANCE IS SO IMPORTANT



The 2019 revision of the **National Construction Code (NCC)** has introduced changes to the way that ventilation systems exhaust air into roof spaces. The ventilation of roof spaces now has a performance measure that must be met to mitigate the effect of damp air being exhausted into these spaces. The changes in the NCC may require a change in installation practices.

3.8.7.3 FLOW RATE AND DISCHARGE OF EXHAUST SYSTEMS:

- a. An exhaust system installed in a kitchen, bathroom, sanitary compartment or laundry must have a minimum flow rate of—
 - i. 25 L/s for a bathroom or sanitary compartment; and
 - ii. 40 L/s for a kitchen or laundry.
- b. Exhaust from a bathroom, sanitary compartment, or laundry must be discharged—
 - i. directly or via a shaft or duct to outdoor air; or
 - ii. to a roof space that is ventilated in accordance with 3.8.7.4.

3.8.7.4 VENTILATION OF ROOF SPACES:

- a. Where an exhaust system covered by 3.8.7.3 discharges into a roof space, the roof space must be ventilated to outdoor air through evenly distributed openings.
- b. Openings required by (a) must have a total unobstructed area of 1/300 of the respective ceiling area if the roof pitch is more than 22°, or 1/150 of the respective ceiling area if the roof pitch is not more than 22°.

CHOOSING THE RIGHT EXHAUST FAN

STEP 1:

Calculate the room volume in cubic meters length (m) × width (m) × height (m) = Xm³

STEP 2:

Check the air changes/hour adapted for your application (refer to the table below)

LOCATION	AIR CHANGES PER HOUR	ROOM	BATHROOM	KITCHEN
Bathrooms	6-10	Volume	2.0m × 2.4m × 2.0m = 9.6m ³	2.4m × 2.8m × 2.4m = 16m ³
Kitchens	15-20	No. of AC/H	6	15
Toilets	6-10	Air movement required	6 × 9.6 = 57.6m ³ /h	16 × 15 = 240m ³ /h
Utility Rooms	15-20		16L/s	67L/s
Laundries	10-30			

STEP 3:

Calculate the max airflow in cubic metres/hour: Volume in cubic metre per hour of the room × Air Changes per Hour.
The result will provide you with the maximum airflow in cubic metres/hour

STEP 4:

Select the fan for your application with a higher performance than the maximum airflow calculated above

CAT NO.	FAN SIZE	DESCRIPTION	EXTRACTION		SUGGESTED APPLICATIONS
			m ³ /h	L/s	
EF100SQWE	100mm	Square white non-ducted Wall exhaust fan	94	26	En, WC
EF100SQSWE	100mm	Square slimline white non-ducted Wall exhaust fan	105	29	En, WC
EFT100SQSWE	100mm	Square slimline white non-ducted Wall exhaust fan with timer	105	29	En, WC
EF100SQSWEKIT	100mm	Square slimline white non-ducted Wall exhaust fan kit	105	29	En, WC
EF100RDWE	100mm	Round white non-ducted Wall exhaust fan	105	29	En, WC
EF150SQWE	150mm	Square white non-ducted Wall exhaust fan	218	60	B, En, K, L, WC
EF150SQSWE	150mm	Square slimline white non-ducted Wall exhaust fan	309	85	B, En, K, L, WC
EFT150SQSWE	150mm	Square slimline white non-ducted Wall exhaust fan with timer	267	74	B, En, K, L, WC
EFH150SQSWE	150mm	Square slimline white non-ducted Wall exhaust fan with humidity sensor	267	74	B, En, K, L, WC
EF150RDWE	150mm	Round white non-ducted Wall exhaust fan	309	85	B, En, K, L, WC
R621/8A	150mm	Square slimline white non-ducted Wall exhaust fan	105	29	B, En, K, L, WC
EFS150SQWE	150mm	Square white with shutters non-ducted Wall exhaust fan	200	55	B, En, K, L, WC
EFS150SQSWE	150mm	Square slimline white with shutters non-ducted Wall exhaust fan	267	74	B, En, K, L, WC
R621/9A	150mm	Square white with shutters non-ducted Wall exhaust fan	105	29	B, En, K, L, WC
EF200RDWE	200mm	Round white non-ducted Ceiling exhaust fan	350	97	B, En, K, L, WC
EF200RDMS	200mm	Round matt silver non-ducted Ceiling exhaust fan	350	97	B, En, K, L, WC
EF200SQWE	200mm	Square white non-ducted Ceiling exhaust fan	350	97	B, En, K, L, WC
EF250RDWE	250mm	Round white non-ducted Ceiling exhaust fan	400	111	B, En, K, L, WC
EF250RDMS	250mm	Round matt silver non-ducted Ceiling exhaust fan	400	111	B, En, K, L, WC
EF250SQWE	250mm	Square white non-ducted Ceiling exhaust fan	400	111	B, En, K, L, WC
EFD01RDWE	250mm	Round white with ducted Ceiling exhaust fan	330	91	B, Bd, En, K, L, WC
EFD01SQWE	250mm	Square white with ducted Ceiling exhaust fan	330	91	B, Bd, En, K, L, WC
EFD01RDWEKIT	150mm	Round white Ceiling exhaust fan Kit	330	91	B, Bd, En, K, L, WC
EFIL100SQWE	100mm	Square white In-line exhaust fan kit	255	70	B, Bd, En, K, L, WC
EFIL150SQWE	150mm	Square white Inline exhaust fan kit	555	154	B, Bd, En, K, L, WC
EFTIL150SQWEKIT	150mm	Square white Inline exhaust fan kit with timer	555	154	B, Bd, En, K, L, WC
BH1WE	-	Single Lamp Instant Heat	-	-	B, En
R615	-	Single Lamp Instant Heat	-	-	B, En
BH2NDWE	240mm	2-lamp non-ducted	240	67	B, En
R622/1AC	240mm	2-lamp non-ducted	240	67	B, En
BH4NDWE	230mm	4-lamp non-ducted	390	108	B, En
R622/2AC	230mm	4-lamp non-ducted	390	108	B, En
BH2DWE	-	2-lamp ducted	180	50	B, En
BH4DWE	-	4-lamp ducted	180	50	B, En
R622D2	-	4-lamp ducted	135	37	B, En

*Legend: B-Bathroom Bd, Bedroom En-Ensuite K-Kitchen L-Laundry WC-Toilet

Please note: While choosing the fan, it is advisable to consider some safety to factor in any bends/kinks in ducting (for ducted fans) and any obstructions to the vent as this will substantially reduce the airflow achieved for each installation. Always refer to the pressure curve of the fan you are installing to ensure the recommended air changes per hour are achieved.

COMPLIANT WITH NCC HPM RANGE

FLOW RATE REQUIRED BY THE NCC 2019

NCC REQUIREMENT	L/s	Equivalent in m³/h
Bathroom or Sanitary compartment	25	90
Kitchen or Laundry	40	144

HPM INLINE EXHAUST FANS

HPM INLINE EXHAUST FANS	DUCT SIZE MM	2M HORIZONTAL DUCTING (1M/SIDE)		5M HORIZONTAL DUCTING (2.5M/SIDE)		3M VERTICAL DUCTING (1.5m/side)		6M VERTICAL DUCTING (3m/side)	
		L/s	Equivalent in m³/h	L/s	Equivalent in m³/h	L/s	Equivalent in m³/h	L/s	Equivalent in m³/h
EFIL100 Speed 1	100	28	100	25	90	24	85	20	72
EFIL100 Speed 2	100	35	125	32	115	30	106	26	92
EFIL150 Speed 1	150	86	310	75	270	78	279	68	243
EFIL150 Speed 2	150	108	390	93	335	98	351	84	302

HPM DUCTED EXHAUST FANS

HPM DUCTED EXHAUST FANS	DUCT SIZE MM	3M HORIZONTAL DUCTING		6M HORIZONTAL DUCTING		3M VERTICAL DUCTING		6M VERTICAL DUCTING	
		L/s	Equivalent in m³/h	L/s	Equivalent in m³/h	L/s	Equivalent in m³/h	L/s	Equivalent in m³/h
efd01 SERIES	150	69	250	63	225	66	238	56	203
BH SERIES	150	50	180	45	162	48	171	41	146
R621D1	100	44	160	33	120	38	136	27	96

RESULTS COMBINATION INLINE EXHAUST FAN + BH SERIES

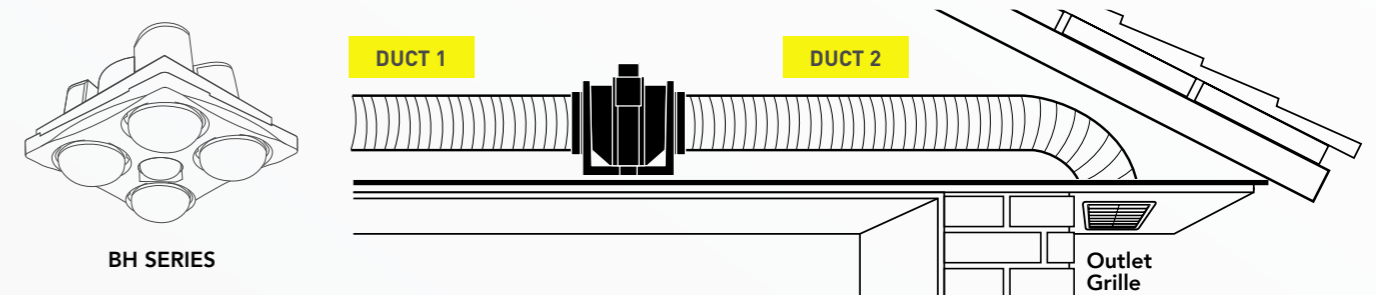

TEST RESULTS

TEST #	EXHAUST FAN 1 BH	DUCT 1 (AS SUPPLIED)	EXHAUST FAN 2 EFIL150SQWE	DUCT 2 (AS SUPPLIED)	EXTERNAL GRILLE Ø150 MM	AIR FLOW (L/S)	AIR FLOW (m³/h)	BACK PRESSURE (PA)
1	Heat 1	3 m * Ø150 mm	OFF	5 m * Ø150 mm	Single bend	14.9	53.8	-0.1
2	Heat 2/Fan	3 m * Ø150 mm	OFF	5 m * Ø150 mm	Single bend	41.7	150.0	0.3
3	Heat 1	3 m * Ø150 mm	ON Speed 1	5 m * Ø150 mm	Single bend	49.4	177.9	0.0
4	Heat 1	3 m * Ø150 mm	ON Speed 2	5 m * Ø150 mm	Single bend	52.4	188.8	0.2
5	Heat 2/Fan	3 m * Ø150 mm	ON Speed 1	5 m * Ø150 mm	Single bend	54.6	196.6	0.0
6	Heat 2/Fan	3 m * Ø150 mm	ON Speed 2	5 m * Ø150 mm	Single bend	56.6	203.6	-0.1
7	OFF	3 m * Ø150 mm	ON Speed 1	5 m * Ø150 mm	Single bend	47.1	169.7	-0.3
8	OFF	3 m * Ø150 mm	ON Speed 2	5 m * Ø150 mm	Single bend	51.3	184.8	0.0
9	Heat 2/Fan	1 m * Ø150 mm	ON Speed 2	7 m * Ø150 mm	Single bend	58.6	210.9	-0.3

Heat1 and Heat2 are specific to BH4D.

Under Heat 1 the fan speed is reduced for BH4 series

Under Heat 2 the fan is at maximum speed for BH4 series.

For BH2 series Heat 1 does not exist. So consider only Heat 2 condition.

Compliant with NCC
 Non-Compliant with NCC

NOTES:

- It is recommended that if fans are installed in series, both fans must be ON at the same time.
- Having the Inline fan OFF as in Test 1 and 2 result is dramatic reduction in airflow.
- The position of Inline fan being closer to the Ceiling Exhaust fan has a slight improvement in Airflow as in Test 9.

Compliant with NCC
 Non-Compliant with NCC

FAN PLACEMENT

The placement is very important to maximise the fan performance.

A balanced airflow is necessary for an exhaust fan to perform at its maximum efficiency. This means that there needs to be a cross flow of air through the room so that the air extracted from the room can be replaced with air drawn from a source such as window, under a door or from an air vent.

Locate the fan, if possible, on the opposite side of the room and as far away as possible from the main fresh air source. Ideally position the fan so vapour sources such as showers and stoves, fall within the air flow path. For bathrooms, it is important to place the fan close to the mirror to avoid fogging.



FAN INSTALLATION

Location of your ventilation fan will depend on the physical constraints of your room. The wet area zone guide will help you decide the most suitable physical installation to meet your requirements. Within the above mounting options there are various other features available:

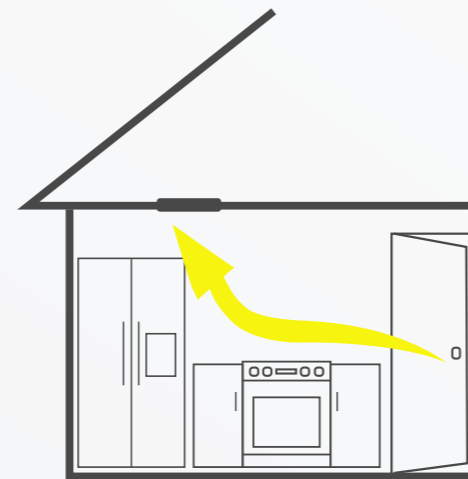

KITCHEN

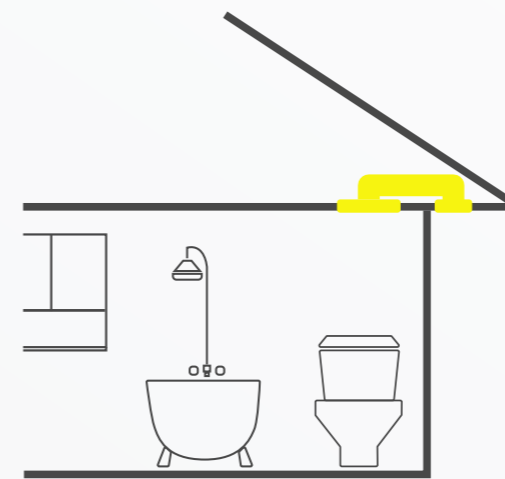

1. CEILING MOUNTED FAN

Designed for low-pitch roofs or between floors, where there is no ceiling access. Also available with heat lamps & lighting.

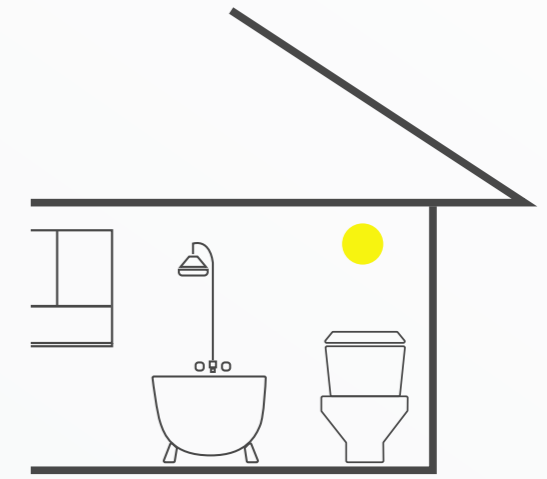

2. WALL MOUNTED FAN

Used where the bathroom is on an external wall, or there is no ceiling space for an in-line fan.

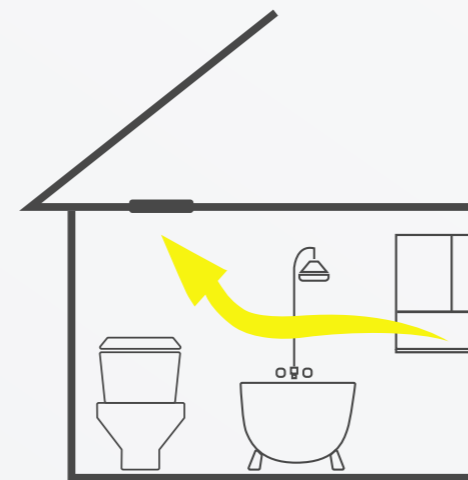

BATHROOM

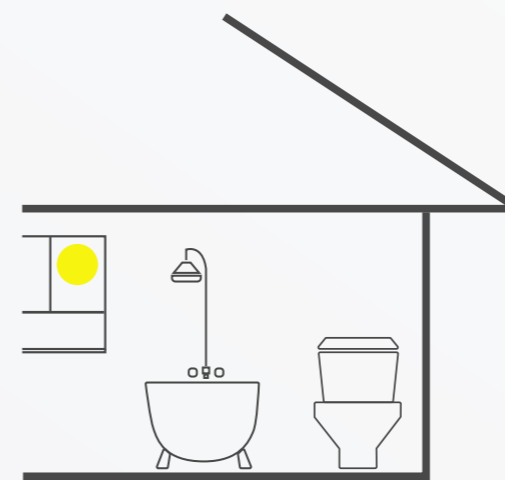

3. WINDOW MOUNTED FAN

Used in situations where an existing window fan is being replaced, or where there is no available external wall space and no ceiling space access.

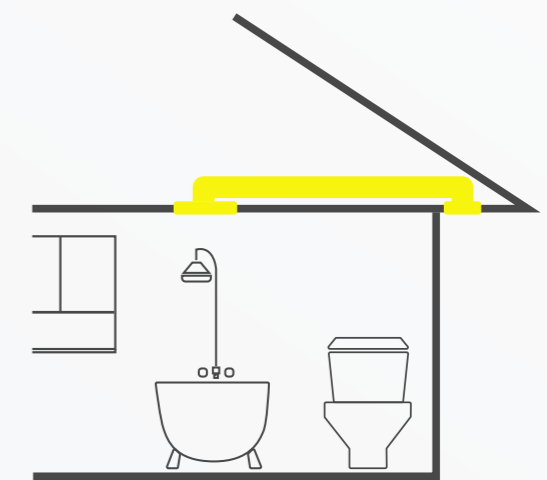

4. IN-LINE MOUNTED FAN KIT

Most common bathroom installation, the fan is mounted in the ceiling space with the grille directly above the source of the steam.

Generally this type of installation is quieter as the fan is not directly in the room.

FAN INSTALLATION

WARNING

You **MUST** have your exhaust fan vented /ducted horizontally to an eave AND must have an open window or 20mm off the base of a door to allow cross ventilation.

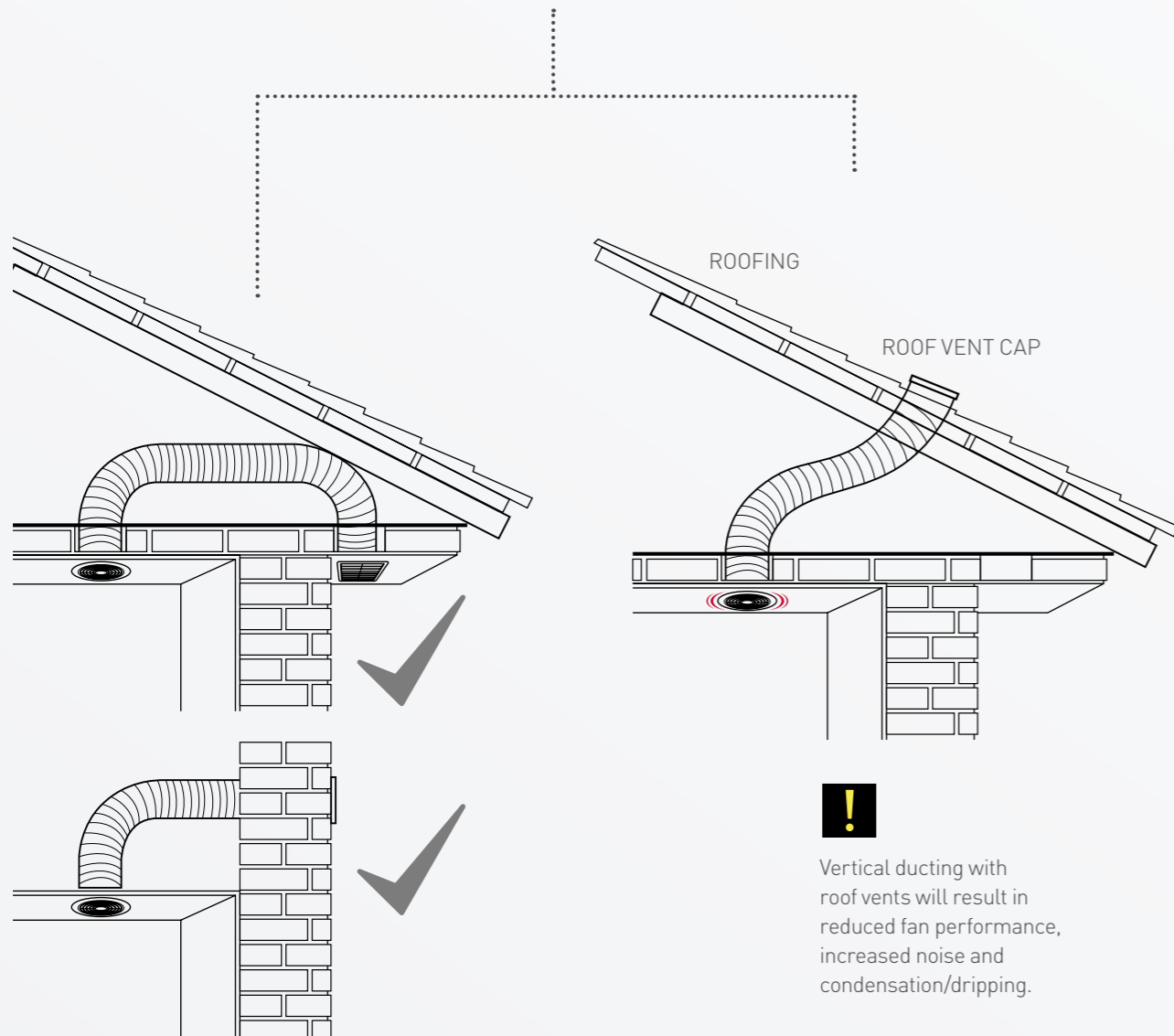

Vertical ducting with roof vents will result in reduced fan performance, increased noise and condensation/dripping.

WET AREA RECOMMENDATIONS & TIPS

It is important to consider the wet areas of a room when you place an instant heater in a bathroom or ensuite. For safety reasons, there are a few rules to follow when installing an exhaust fan close to a shower:

1. It is necessary to respect zones of installations

- Zone 0:** This is the interior of the bathtub or shower basin
- Zone 1:** This extends above zone 0 and around the perimeter of the bath or shower basin to 2.25m for NZ and 2.5m for Australia above the floor level
- Zone 2:** This extends 600mm beyond Zone 1 and to a height of 2.25m for NZ and 2.5m for Australia above floor level

Where possible we recommended your fan is not installed directly above the shower/bath as condensation may occur causing dripping.

Note: Example shown is typical only. Consult AS/NZS 3000 for full definition of installation zones in wet areas.

2. You **MUST** have your exhaust fan vented /ducted horizontally to an eave AND must have an open window or 20mm off the base of a door to allow cross ventilation

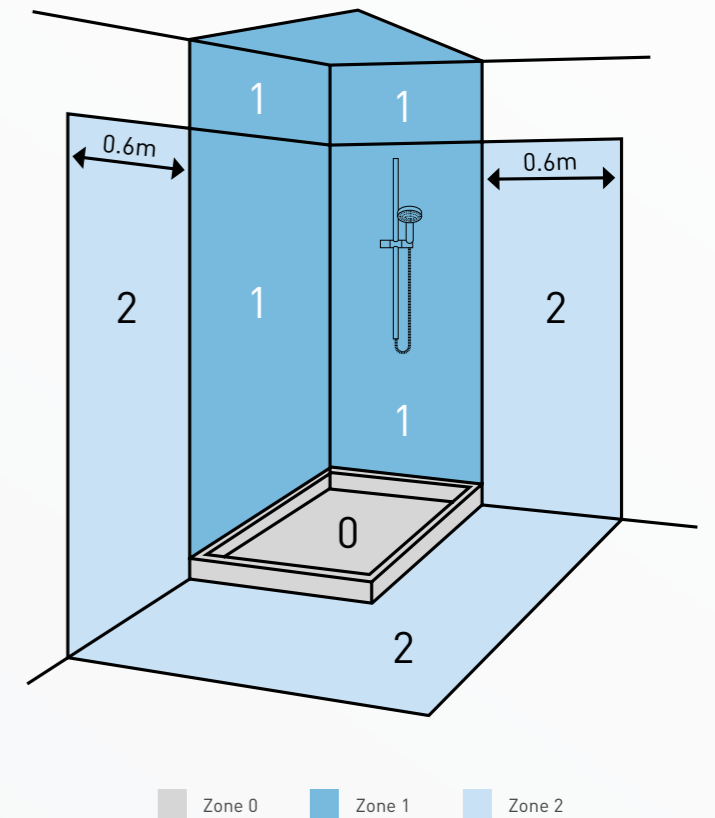

TIPS

- Positioning fans as high as possible will increase the exhaustion of air often trapped near the ceiling.
- Wall mounting – Check your potential position has no hidden pipes or cables nearby, and your potential position on the outside wall is free of drainpipes.
- Ceiling mounting – Check the area above the proposed fan location is free of joists, pipes or cable.
- Window mounting – HPM recommends a professional glazier pre-cuts the glass. If there is pre-existing stress in the glass, it could crack during cutting.
- Clean fan grilles periodically by removing obstructions from both inlets and outlets to help ensure maximum performance.
- To extend the life of an exhaust fan or heat lamp, operate upon entering the room – before using room facilities. For example, before having a shower.
- It is advisable to run the exhaust fan for a few minutes after using the shower to avoid dripping due to condensation from the fan and on walls/ceilings.

WALL EXHAUST FAN NON-DUCTED

100MM SERIES

If you like contemporary design and have a small space to ventilate, these are the perfect exhaust fans.



EF100SQWE

Main applications

Perfect for residential bathrooms



EF100SQSWE
EFT100SQSWE



NEW



EF100SQSWEKIT



EF100RDWE



	EF100SQWE	EF100SQSWE EFT100SQSWE EF100SQSWEKIT EF100RDWE
Exhaust fan	100mm axial	100mm axial
Frequency	50Hz	50Hz
Supply voltage	230 – 240V a.c	230 – 240V a.c
Motor rating	14W	14W
Maximum airflow	94m³/h = 26L/s	105m³/h = 29L/s
Draft stopper	Yes	Yes
Auto shutters	No	No
Required wall cavity/ceiling depth	>200mm	>200mm
IP weatherproof rating	IP44	IP24
Weight	500g	450g
Product codes	White Fascia Square	EF100SQWE
	White Fascia Slimline Square	EF100SQSWE
	White Fascia Slimline Square with Timer	EFT100SQSWE
	White Fascia Slimline Square	EF100SQSWEKIT
	White Fascia Slimline Round	EF100RDWE

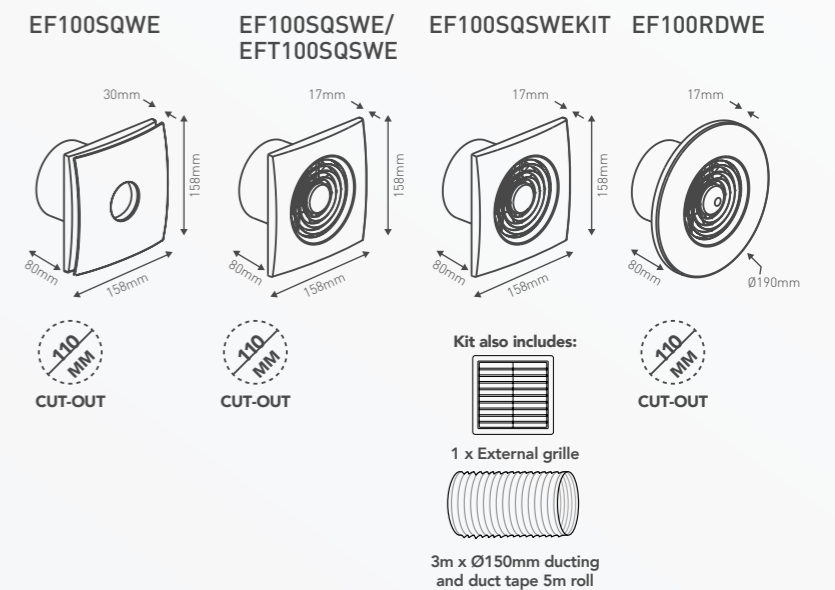

WALL/CEILING EXHAUST FAN NON-DUCTED

150MM SERIES

These versatile exhaust fans are ideal for medium to large spaces.



EF150SQWE

Main applications

Perfect for residential bathrooms

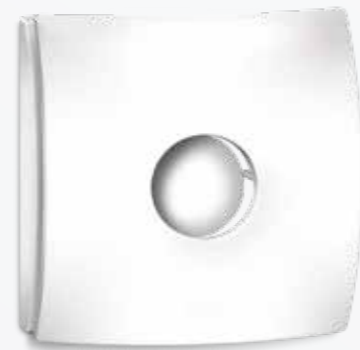

EF150RDWE



EF150SQSWE
EFT150SQSWE
EFH150SQSWE



R621/8A



NEW



	EF150SQWE	EF150SQSWE/ EF150RDWE	EFT150SQSWE/ EFH150SQSWE	R621/8A
Exhaust fan	150mm axial	150mm axial	150mm axial	150mm axial
Frequency	50Hz	50Hz	50Hz	50Hz
Supply voltage	230 – 240V a.c	230 – 240V a.c	230 – 240V a.c	230 – 240V a.c
Motor rating	24W	24W	24W	29W
Maximum airflow*	218m³/h = 60L/s	309m³/h = 108L/s	267m³/h = 74L/s	245m³/h = 68L/s
Draft stopper	Yes	Yes	Yes	No
Required wall cavity/ceiling depth	>310mm	>310mm	>310mm	>300mm
IP weatherproof rating	IP44	IP24	IP24	IP44
Weight	1kg	0.9kg	1.1kg	1.3kg

Product codes	
White Fascia Square	EF150SQWE
White Fascia Slimline Square	EF150SQSWE
White Fascia Slimline Round	EF150RDWE
White Fascia Slimline Square with Timer	EFT150SQSWE
White Fascia Slimline Square with Humidity Sensor	EFH150SQSWE
White Fascia Square	R621/8A

EF150SQWE

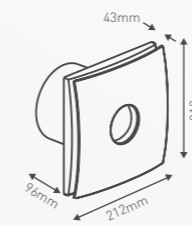

CUT-OUT

EF150SQSWE
EFT150SQSWE
EFH150SQSWE

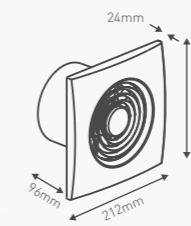

CUT-OUT

EF150RDWE

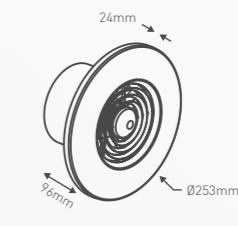

CUT-OUT

R621/8A

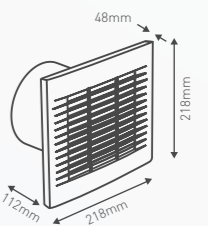

CUT-OUT

*Airflow dependent on installation conditions

WALL/CEILING EXHAUST FAN WITH AUTO SHUTTERS NON-DUCTED

150MM SERIES

Complete with a hardworking draft stopper, it reduces air entering and escaping from the room, helping the home remain warmer in winter and cooler in summer.



EFS150SQWE



TIP
Prevents back-draft



EFS150SQSWE



R621/9A



	EFS150SQWE	EFS150SQSWE	R621/9A
Exhaust fan	150mm axial	150mm axial	150mm axial
Frequency	50Hz	50Hz	50Hz
Supply voltage	230 – 240V a.c	230 – 240V a.c	230 – 240V a.c
Motor rating	24W	24W	29W
Maximum airflow*	200m³/h = 55L/s	267m³/h = 74L/s	245m³/h = 68L/s
Draft stopper	Auto shutter	Auto shutter	Auto shutter
Required wall cavity/ceiling depth	>310mm	>310mm	>300mm
IP weatherproof rating	IP44	IP24	IP44
Weight	1.2kg	1.1kg	1.3kg
Product codes	White Fascia Square	White Fascia Slimline Square	White Fascia Square
			EFS150SQWE
			EFS150SQSWE
			R621/9A

EFS150SQWE

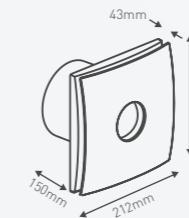

EFS150SQSWE

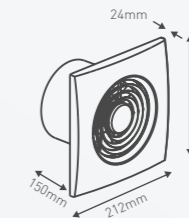

R621/9A

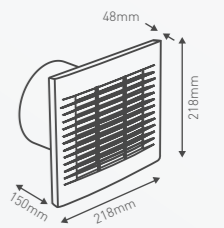

*Airflow dependent on installation conditions

CEILING EXHAUST FAN NON-DUCTED

200MM SERIES

These exhaust fans are ideal for retrofit home installations in bathrooms, kitchens and laundries. The modern 'honeycomb' fascia design maximises airflow and prevents dirty dust build-up. The high quality motor has a greater resistance to high temperatures, quieter operation, and longer lifespan than common alternatives.



EF200RDWE

Main applications
Perfect for residential
bathrooms



EF200RDMS

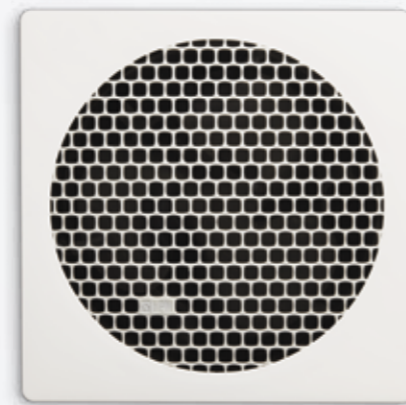

EF200SQWE

	EF200RDWE/ EF200RDMS/ EF200SQWE
Exhaust fan	200mm axial
Frequency	50Hz
Supply voltage	230 – 240V a.c
Motor rating	35W
Maximum airflow	350m ³ /h = 97L/s
Draft stopper	No
Required wall cavity/ceiling depth	>130mm
Weight	1.1kg
Product codes	
White Fascia Round	EF200RDWE
Matt Silver Fascia Round	EF200RDMS
White Fascia Square	EF200SQWE

EF200RDWE and EF200RDMS

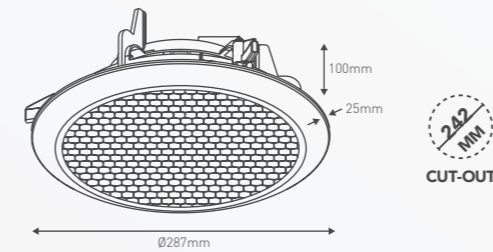

EF200SQWE

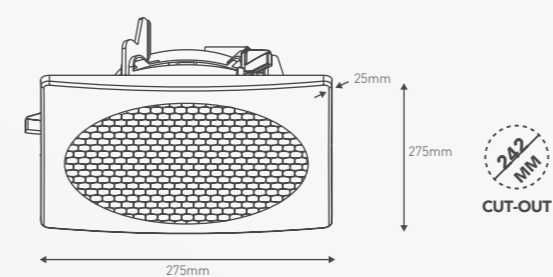

CEILING EXHAUST FAN NON-DUCTED

250MM SERIES

These exhaust fans are ideal for retrofit home installations in bathrooms, kitchens and laundries. The modern 'honeycomb' fascia design maximises airflow and prevents dirty dust build-up. The high quality motor has a greater resistance to high temperatures, quieter operation, and longer lifespan than common alternatives.



EF250RDWE

Main applications
Perfect for residential bathrooms



EF250RDMS

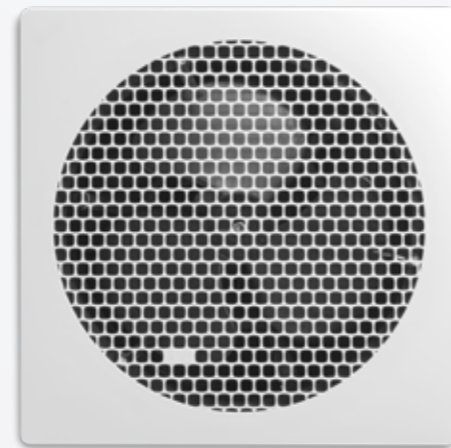

EF250SQWE

	EF250RDWE/ EF250RDMS/ EF250SQWE
Exhaust fan	250mm axial
Frequency	50Hz
Supply voltage	230 - 240V a.c
Motor rating	38W
Maximum airflow rate	400m ³ /h = 111L/s
Draft stopper	No
Required ceiling depth	≥130mm
Weight	1.3kg

Product codes	
White Fascia Round	EF250RDWE
Matt Silver Fascia Round	EF250RDMS
White Fascia Square	EF250SQWE

EF250RDWE and EF250RDMS

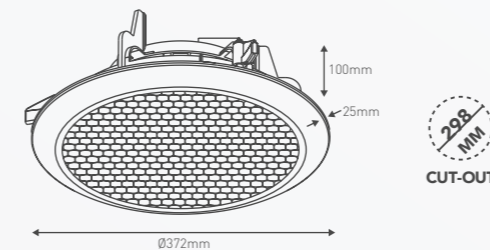

EF250SQWE

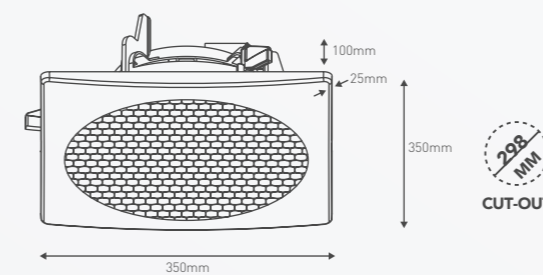

CEILING EXHAUST FAN DUCTED 150MM SERIES

For bathrooms with restricted ceiling spaces, this exhaust fan extracts steam and air outside preventing moisture damage.



Main applications
Perfect for residential bathrooms

EFD01RDWE



EFD01SQWE



EFD01RDWEKIT



	EFD01RDWE EFD01SQWE EFD01RDWEKIT
Exhaust fan	Centrifugal
Frequency	50Hz
Supply voltage	230 – 240V a.c
Motor rating	40W
Maximum airflow rate	330m ³ /h = 92L/s without duct 250m ³ /h = 69L/s with Ø150mm x 3m duct
Draft stopper	Yes
Duct Requirement	Ø150mm & 3m long
Required ceiling depth	>190mm
Weight	1.3kg
Product codes	
White Fascia Round	EFD01RDWE
White Fascia Square	EFD01SQWE
White Fascia Round	EFD01RDWEKIT

EFD01RDWE

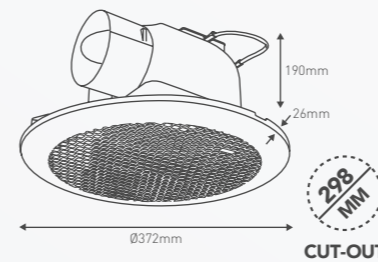

EFD01RDWEKIT



EFD01SQWE

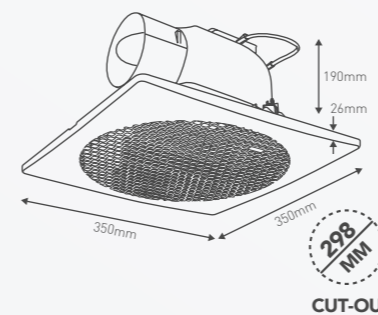

Kit also includes:



1 x External grille

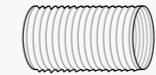

3m x Ø150mm ducting and duct tape 5m roll



INLINE EXHAUST FAN DUCTED KIT

100MM & 150MM SERIES

The inline fan is designed to extract steam and odours from a bathroom and expel it to the exterior through an eave outlet. It is also suitable for extracting air from one room and expelling it to another room. This inline feature allows the inlet grille to be mounted in wet areas, or even above the shower, and because the motor is in the ceiling cavity, noise from the fan is minimal.

Main applications

Ideal for transferring hot or cool air from air-conditioning, fireplaces, and oil heaters from room to another



	EFIL100SQWE	EFIL150SQWE/ EFTIL150SQWEKIT/ EFLIL150SQWEKIT
Exhaust fan	100mm axial	150mm axial
Frequency	50Hz	50Hz
Supply voltage	230 – 240V a.c	230 – 240V a.c
Motor rating	30W	60W
Maximum airflow rate	255m ³ /h = 71L/s without duct 115m ³ /h = 32L/s with Ø100mm x 5m duct	555m ³ /h = 154L/s without duct 335m ³ /h = 93L/s with Ø150mm x 5m duct
Lamp/Light only for EFLIL150SQWEKIT	-	LED MR16 5W max
Draft stopper	Yes	Yes
Duct Requirement	Ø100mm & 5m long	Ø150mm & 5m long
IP weatherproof rating	IP55	IP55
Weight	1.9kg	3kg
Inclusions	5m x Ø100mm duct, external grille, duct tape and cable ties	5m x Ø150mm duct, external grille, duct tape, cable ties and timer or light
Product codes		
White Fascia Square 100mm		EFIL100SQWE
White Fascia Square 150mm		EFIL150SQWE
White Fascia Square 150mm with Timer		EFTIL150SQWEKIT
White Fascia Square 150mm with Light		EFLIL150SQWEKIT

2 SPEED SWITCH

UP TO MAX AIRFLOW 555m³/h

5 YEAR WARRANTY





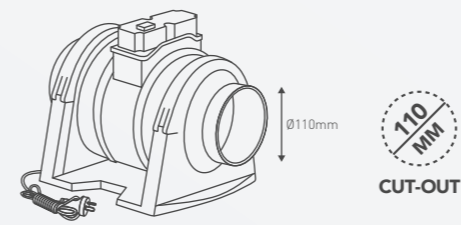

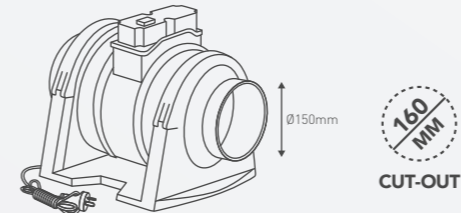

EFIL100SQWE







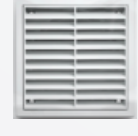
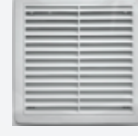



EFIL150SQWE/EFTIL150SQWEKIT/ EFLIL150SQWEKIT



ACCESSORIES

	CAT. NO.	DESCRIPTION
	R621/4D	WALL KIT Ø100mm Fixed Square Grille Kit - with duct, cable ties, wall plugs and external grille
	R621/6D	WALL KIT Ø150mm Fixed Square Grille Kit - with duct, cable ties, wall plugs and external grille
	R621/6WA	WINDOW FAN KIT Ø150mm Window Square Grille Kit - with gaskets, flush plate and external grille
	EFGR200RDWE	REPLACEMENT GRILLES Ø200mm Round white finish. Compatible with EF200 series
	EFGR250RDWE	REPLACEMENT GRILLES Ø250mm Round white finish. Compatible with EF250 series
	FG100	EXTERNAL GRILLES Ø100mm Fixed Square Grille
	FG150	EXTERNAL GRILLES Ø150mm Fixed Square Grille
	GG100	EXTERNAL GRILLES Ø100mm Square Gravity Grille
	GG150	EXTERNAL GRILLES Ø150mm Square Gravity Grille

ACCESSORIES

	CAT. NO.	DESCRIPTION
	A505	EXTERNAL GRILLES Ø150mm Round Ceiling/Wall diffuser
	RG100	EXTERNAL GRILLES Ø100mm Round Grille
	RG150	EXTERNAL GRILLES Ø150mm Round Grille
	WPG100	EXTERNAL GRILLE Ø100mm Weatherproof Cowl
	WPG150	EXTERNAL GRILLE Ø150mm Weatherproof Cowl
	AD1003	DUCTING Ø100mm x 3m length
	AD1503	DUCTING Ø150mm x 3m length
	R621D2DA	DUCT ADAPTOR Ø100 to Ø150mm duct adaptor
	EF100/150TD	TIME DELAY MODULE 1-29min for EF100 & 150 series wall fans

RANGE OVERVIEW

	CAT. NO.	FINISH COLOUR	DIAMETER	MOTOR RATING	MAX AIR FLOW	IP WEATHERPROOF RATING
WALL EXHAUST FAN NON-DUCTED	EF100SQWE	White	100mm	14W	94m³/h	IP44
	EF100SQSWE	White	100mm	14W	105m³/h	IP24
	EFT100SQSWE	White	100mm	14W	105m³/h	IP24
	EF100SQSWEKIT	White	100mm	14W	105m³/h	IP24
	EF100RDWE	White	100mm	14W	105m³/h	IP24
	EF150SQWE	White	150mm	24W	218m³/h	IP44
	EF150SQSWE	White	150mm	24W	309m³/h	IP24
	EF150RDWE	White	150mm	24W	309m³/h	IP24
	EFT150SQSWE	White	150mm	24W	267m³/h	IP24
	EFH150SQSWE	White	150mm	24W	267m³/h	IP24
	R621/8A	White	150mm	29W	245m³/h	IP44
AUTO-SHUTTER NON-DUCTED	EFS150SQWE	White	150mm	24W	200m³/h	IP44
	EFS150SQSWE	White	150mm	24W	267m³/h	IP24
	R621/9A	White	150mm	29W	245m³/h	IP44
CEILING EXHAUST FAN NON-DUCTED	EF200RDWE	White	200mm	35W	350m³/h	N/A
	EF200RDMS	Silver	200mm	35W	350m³/h	N/A
	EF200SQWE	White	200mm	35W	350m³/h	N/A
	EF250RDWE	White	250mm	38W	400m³/h	N/A
	EF250RDMS	Silver	250mm	38W	400m³/h	N/A
	EF250SQWE	White	250mm	38W	400m³/h	N/A

RANGE OVERVIEW

	CAT. NO.	FINISH COLOUR	DIAMETER	MOTOR RATING	MAX AIR FLOW	IP WEATHERPROOF RATING
CEILING EXHAUST FAN DUCTED	EFD01RDWE	White	150mm	40W	330m³/h	N/A
	EFD01SQWE	White	150mm	40W	330m³/h	N/A
	EFD01RDWEKIT	White	150mm	40W	330m³/h	IP24
IN-LINE EXHAUST FAN DUCTED	EFIL100SQWE	White	100mm	30W	255m³/h	IP55
	EFIL150SQWE	White	150mm	60W	555m³/h	IP55
	EFTIL150SQWEKIT	White	150mm	60W	555m³/h	IP24
	EFLIL150SQWEKIT	White	150mm	60W	555m³/h	IP55



INSTANT HEAT



INSTANT HEAT SINGLE LAMP NON-DUCTED

Perfect for retrofit home installations in ensuites and small bathrooms, this handy single heat lamp can help ward off the shivers in those cold months. The infrared heat lamps provide a focused source of fast, radiant heat making them ideal to be placed directly over the drying area for optimal heating performance.



BH1WE



R615

Main applications
Perfect for small bathrooms, toilets or ensuites

	BH1WE	R615
Heat lamps	1 x 275W	1x 275W
Max power consumption	375W	275W
Frequency	50Hz	50Hz
Supply voltage	230 - 240V a.c	230 - 240V a.c
Thermal overload protection	100°C	N/A
Required ceiling depth	>300mm	>300mm
Weight	950g	750g
Product codes	White	BH1WE
	White	R615

BH1WE

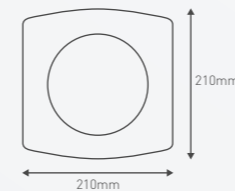

CUT-OUT

R615



CUT-OUT

↓↓↓
**INSTANT
POWERFUL
HEATING**
275W HEAT LAMP

SAFE
THERMAL
OVERLOAD
PROTECTION

**5 YEAR
WARRANTY**



INSTANT HEAT 3-IN-1 NON-DUCTED

TWO LAMPS

Ideal for retrofit home installations. The Instant Heat 3-in-1 combines lighting, heating and ventilation in one stylish unit. The heat lamps, exhaust fan and centre light can be used separately or together to create the perfect bathroom environment. While the heat lamps produce instant heat, the centre light provides general illumination and the exhaust fan extracts steam and moisture.



BH2NDWE



Main applications

Perfect for small bathrooms and ensuites



R622/1AC

	BH2NDWE	R622/1AC
Centre Light	7W LED R80 E27 600 lm	100W ES
Heat lamps	2 x 275W	2 x 275W
Exhaust fan	240mm axial	240mm axial
Max power consumption	690W	690W
Frequency	50Hz	50Hz
Supply voltage	230 – 240V a.c	230 – 240V a.c
Motor rating	40W	40W
Maximum airflow	240m ³ /h = 67 L/s	240m ³ /h = 67 L/s
Required ceiling depth	>500mm	>500mm
Weight	3.3kg	3.3kg
Inclusions	Excel Life 3-gang switch engraved HEAT, FAN, LIGHT	Excel 3-gang switch engraved HEAT, FAN, LIGHT
Product codes	White Fascia White Fascia	BH2NDWE R622/1AC

BH2NDWE

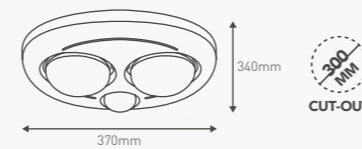

R622/1AC

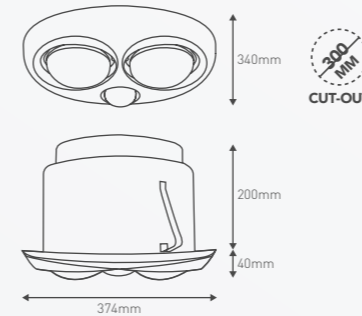

INSTANT POWERFUL HEATING
 2 x 275W HEAT LAMPS

UP TO MAX AIRFLOW
 240m³/h

5 YEAR WARRANTY



INSTANT HEAT 3-IN-1 NON-DUCTED

FOUR LAMPS

Relish the toasty comfort of four heat lamps for keeping warm in the cooler months. The heat lamps, exhaust fan and light in this stylish unit can be used together or separately so you can create the perfect environment, whatever the reason or season. Ideal for retrofit home installations.



BH4NDWE

Main applications
Perfect for medium-large bathrooms



R622/2AC

INSTANT POWERFUL HEATING
 4 x 275W HEAT LAMPS

UP TO **MAX AIRFLOW**
 400m³/h

5 YEAR WARRANTY

	BH4NDWE	R622/2AC
Centre Light	7W LED R80 E27 600 lm	100W ES
Heat lamps	4 x 275W	4 x 275W
Exhaust fan	230mm axial	230mm axial
Max power consumption	1240W	1240W
Frequency	50Hz	50Hz
Supply voltage	230 – 240V a.c	230 – 240V a.c
Motor rating	40W	40W
Maximum airflow	390m³/h = 108L/s	390m³/h = 108L/s
Required ceiling depth	>500mm	>500mm
Weight	4.5kg	4.5kg
Inclusions	Excel Life 4-gang switch engraved HEAT, HEAT, FAN, LIGHT	Excel 4-gang switch engraved HEAT, HEAT, FAN, LIGHT
Product codes	White Fascia White Fascia	BH4NDWE R622/2AC

BH4NDWE

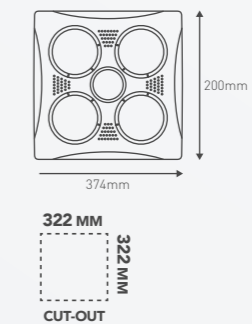

R622/2AC

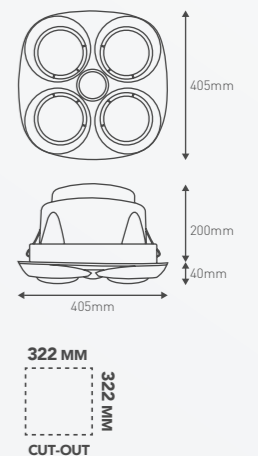

INSTANT HEAT 3-IN-1 DUCTED TWO LAMPS

A combination of light, heater and ducted exhaust fan perfect for smaller bathrooms and ensuites. Ducting to the outside prevents condensation damage to the ceiling.

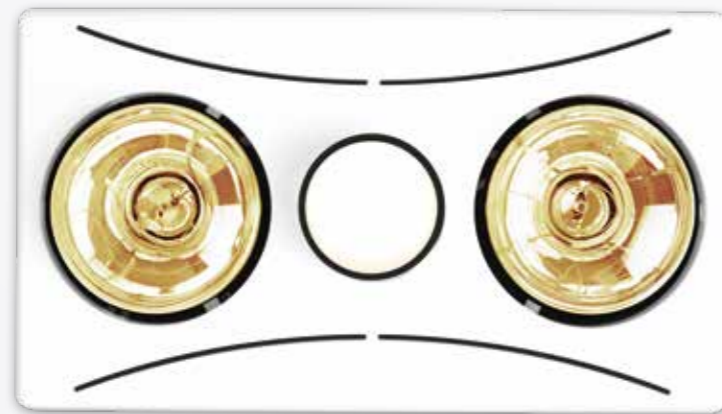

BH2DWE



R622D1



Main applications

Perfect for small bathrooms and ensuites

INSTALLATION

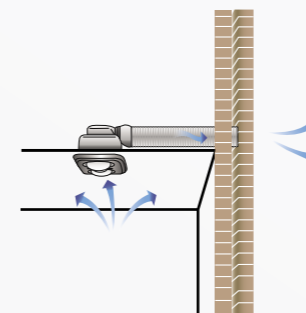

Multi storey application

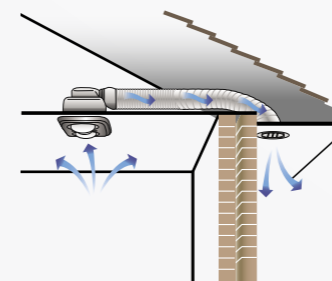

Standard roof application

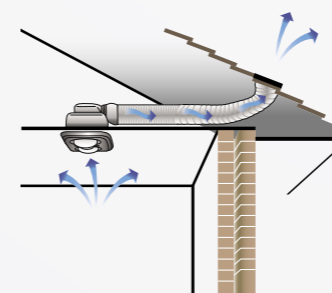

Vertical roof application

NOTE: Vertical ducting with roof vents may result in reduced fan performance, increased noise and condensation/dripping.



INSTANT POWERFUL HEATING
 2 x 275W HEAT LAMPS
UP TO MAX AIRFLOW
 180m³/h
DUCTING KIT INCLUDED
5 YEAR WARRANTY

	BH2DWE	R622D1
Centre Light	7W LED R80 E27	60W Incandescent lamp
Heat lamps	2 x 275W	2 x 275W
Exhaust fan	Centrifugal	Centrifugal
Max power consumption	840W	630W
Frequency	50Hz	50Hz
Supply voltage	230 – 240V a.c	230 – 240V a.c
Motor rating	50W	16W
Maximum airflow	200m³/h = 56L/s without duct 180m³/h = 50L/s with Ø150mm x 3m duct	116m³/h = 32L/s without duct 95m³/h = 26L/s with Ø100mm x 3m duct
Thermal overload protection	100°C	N/A
Required ceiling depth	>300mm	>220mm
Draft stopper built-in	Yes	Yes
Weight	4.3kg	3.0kg
Inclusions	Excel Life 3-gang switch engraved HEAT, FAN, LIGHT. 3m x Ø150mm duct, external grille, duct tape and cable ties	Excel 3-gang switch engraved HEAT, FAN, LIGHT. 3m x Ø100mm duct, external grille, duct tape and cable ties
Product codes	White Fascia 2 lamp	BH2DWE
	White Fascia 2 lamp	R622D1

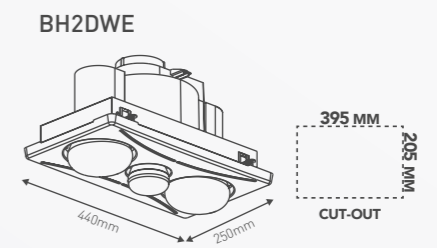

INSTANT HEAT 3-IN-1 DUCTED FOUR LAMPS

A combination of light, heater and ducted exhaust fan perfect for larger bathrooms and ensuites. Ducting to the outside prevents condensation damage to the ceiling.



INSTANT POWERFUL HEATING
 2 x 275W HEAT LAMPS

UP TO MAX AIRFLOW
 240m³/h

DUCTING KIT INCLUDED

5 YEAR WARRANTY



Main applications
Perfect for larger bathrooms and ensuites



BH4DWE



R622D2

INSTALLATION

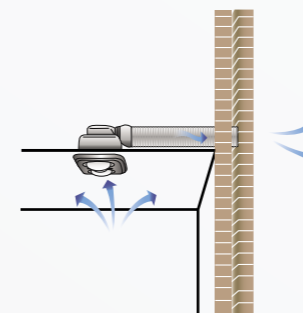

Multi storey application

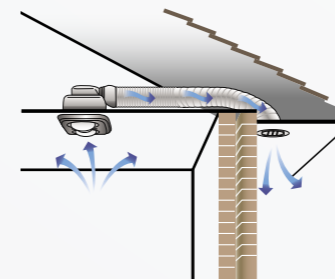

Standard roof application

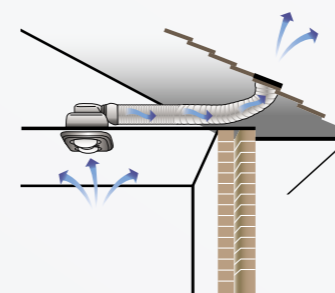

Vertical roof application

NOTE: Vertical ducting with roof vents may result in reduced fan performance, increased noise and condensation/dripping.

	BH4DWE	R622D2
Centre Light	7W LED R80 E27	100W R80 Incandescent lamp
Heat lamps	4 x 275W	4 x 275W
Exhaust fan	Centrifugal	Centrifugal
Max power consumption	1570W	1240W
Frequency	50Hz	50Hz
Supply voltage	230 – 240V a.c	230 – 240V a.c
Motor rating	50W	30W
Maximum airflow	200m³/h = 56L/s without duct 180m³/h = 50L/s with Ø150mm x 3m duct	189m³/h = 53L/s without duct 135m³/h = 38L/s with Ø100mm x 3m duct
Thermal overload protection	100°C	N/A
Required ceiling depth	>300mm	>260mm
Draft stopper built-in	Yes	Yes
Weight	5.2kg	4.5kg
Inclusions	Excel Life 4-gang switch engraved HEAT, HEAT, FAN, LIGHT 3m x Ø150mm duct, external grille, duct tape and cable ties	Excel 4-gang switch engraved HEAT, HEAT, FAN, LIGHT 3m x Ø100mm duct, external grille, duct tape and cable ties
Product codes	White Fascia 4 lamp	BH4DWE
	White Fascia 4 lamp	R622D2

BH4DWE

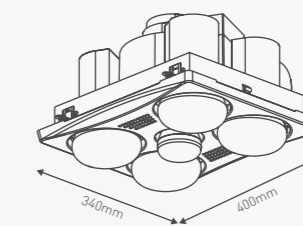

R622D2

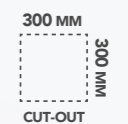
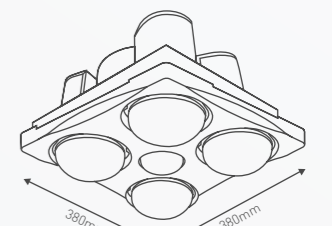

POSITIONING OF INSTANT HEAT & TIPS

It is important to consider the wet areas of a room when you place an instant heater in a bathroom or ensuite. For safety reasons, there are a few rules to follow when installing an exhaust fan close to a shower:

1. It is necessary to respect zones of installations

- Zone 0:** This is the interior of the bathtub or shower basin
- Zone 1:** This extends above zone 0 and around the perimeter of the bath or shower basin to 2.25m for NZ and 2.5m for Australia above the floor level
- Zone 2:** This extends 600mm beyond Zone 1 and to a height of 2.25m for NZ and 2.5m for Australia above floor level

Where possible we recommended your fan is not installed directly above the shower/bath as condensation may occur causing dripping.

Note: Example shown is typical only. Consult AS/NZS 3000 for full definition of installation zones in wet areas.

2. You MUST have your exhaust fan vented/ducted horizontally to an eave AND must have an open window or 20mm off the base of a door to allow cross ventilation.

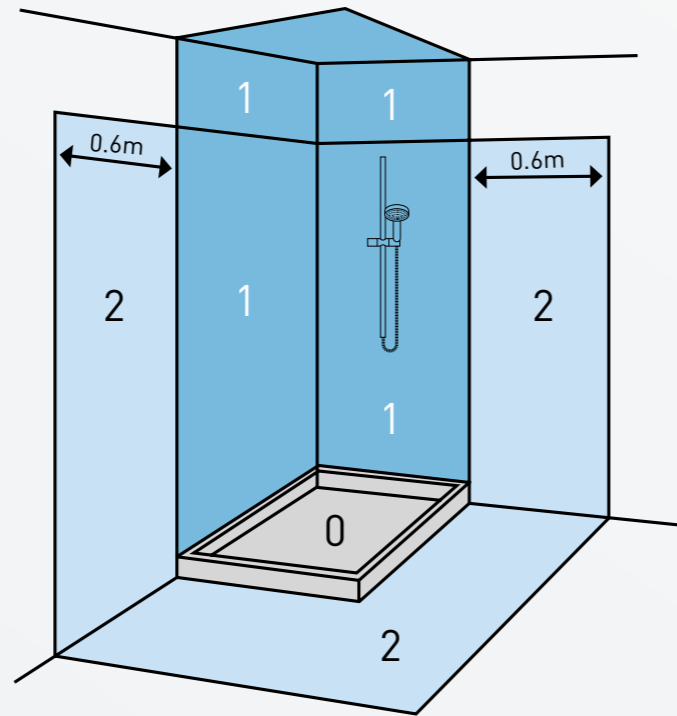

■ Zone 0 ■ Zone 1 ■ Zone 2

TIPS

- Choose the position where your heat lamp will be installed carefully.
- It is recommended to place the heater in the middle of the room for it not to be near the wet areas
- You should also position the heater directly to the place where you will be standing when you will need the heat after you have left your bath or shower
- Instant heat should be cleaned every 6 months or more often to prevent dust buildup

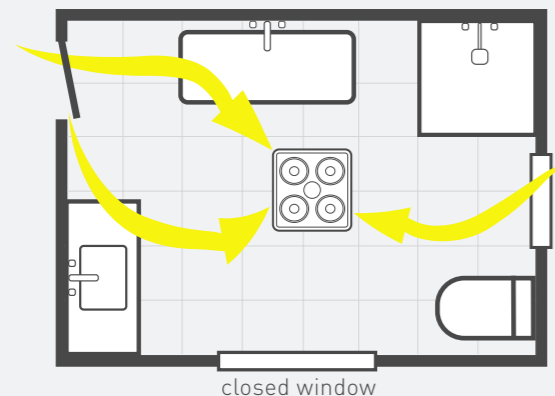

Heat lamps are not designed to heat entire rooms, but to provide instant and focused heat directly below. Position an Instant Heat directly over the drying area for optimal heat performance.

The exhaust fan in the Instant Heat requires a balanced air flow to perform at maximum efficiency. This means there needs to be air flowing into the room from sources such as windows, vents or under doors to allow a cross flow of air movement.

RANGE OVERVIEW

CAT. NO	DESCRIPTION	FINISH COLOUR	DUCTED	MOTOR RATING	MAX POWER CONSUMPTION	HEAT LAMPS	EXHAUST FAN TYPE	MAX AIR FLOW
BH1WE	Single Lamp Instant Heat	White	No	N/A	375W	1 x 275W	N/A	N/A
R615	Single Lamp Instant Heat	White	No	N/A	275W	1 x 275W	N/A	N/A
BH2NDWE	2-lamp non-ducted	White Fascia	No	40W	690W	2 x 275W	Axial	240m³/h
R622/1AC	2-lamp non-ducted	White Fascia	No	40W	690W	2 x 275W	N/A	250m³/h
BH4NDWE	4-lamp non-ducted	White Fascia	No	40W	1240W	4 x 275W	Axial	390m³/h
R622/2AC	4-lamp non-ducted	White Fascia	No	40W	1240W	4 x 275W	N/A	400m³/h
BH2DWE	2-lamp ducted	White Fascia	Yes	50W	840W	2 x 275W	Centrifugal	200m³/h
R622D1	2-lamp ducted	White Fascia	Yes	16W	630W	2 x 275W	Centrifugal	116m³/h
BH4DWE	4-lamp ducted	White Fascia	Yes	50W	1570W	4 x 275W	Centrifugal	200m³/h
R622D2	4-lamp ducted	White Fascia	Yes	30W	1240W	4 x 275W	Centrifugal	189m³/h



CEILING SWEEP FANS

CLASSIC STREAMLINE DESIGN

We believe fans should be designed to be timeless and discreet.

Whether you're in the tropics, the outback, the suburbs, or remote New Zealand, we want to keep you cool and comfortable without costing you a fortune.

So we've designed and engineered our fans in Australia to provide maximum performance for minimum energy consumption. We've also focused on making them easier to install.

Simple, reliable and good value for money; you can't beat that.



Summer and Winter mode switch



ENERGY-SAVING TIP

By optimising air flow, ceiling fans can significantly reduce air-conditioning and heating bills.

GUIDE TO CHOOSING THE RIGHT FAN

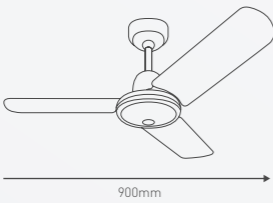
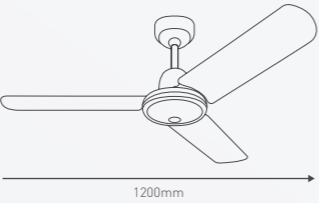
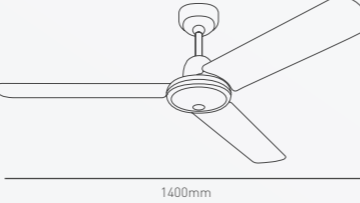
ROOM DIMENSIONS	Up to 12m ²	12 - 27m ²	27+m ²
			
SUGGESTED FAN SIZE	900mm	1200mm	1400mm
RECOMMENDATIONS	Ideal for lounge rooms, living areas and master bedrooms	Ideal for medium to small rooms	Ideal for kitchens, dining rooms, kids bedrooms and offices

SUMMER & WINTER MODES EXPLAINED

We've added a simple toggle switch on all our fans so it's easy to switch between Summer mode for the warmer months and Winter mode for the cooler months. This optimises the fan's performance and increases comfort.



SUMMER MODE

In the warmer months, you want the blades to rotate clockwise to push cool air down. This creates a wind chill effect and evaporates perspiration from skin to keep everyone comfortable.



WINTER MODE

In the cooler months, you want the blades to rotate counter-clockwise at a low speed to pull air up. A gentle updraft will push warm air, which naturally rises to the ceiling, down along the walls to the floor to keep everyone snug.

REGULATION REQUIREMENT

The Australian & New Zealand Standard implies that the lowest point of the fan blades must be installed at least 2.1m from the floor and the blades at least 300mm from the nearest wall.

FEATURES OVERVIEW

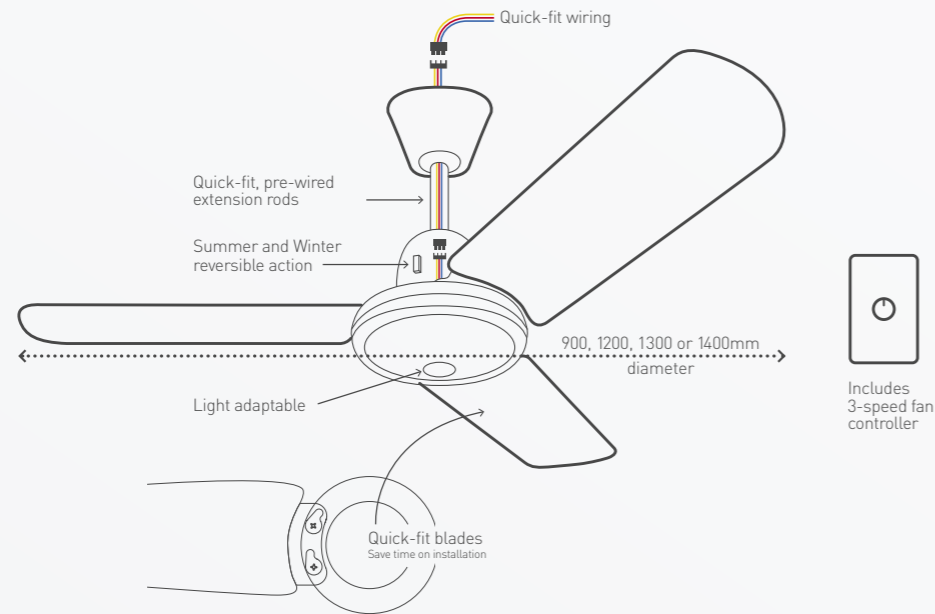

DESIGN FEATURES



QUICK-FIT WIRING

For super fast installation
No need to bring up the fan on the ladder



REMOTE CONTROL

Compatible with all models
Perfect for retrofit installations



PRE-WIRED REPLACEABLE DOWNRODS

For easy extension



LIGHT AVAILABLE

For convenience and space-saving



QUICK-FIT BLADES

For less hassle and rapid fit-off



MAXIMUM AIRFLOW

Enables maximum cooling whilst
maintaining quiet operation



HANG-SURE & J-HOOK MODELS

For level and inclined ceilings



AUSTRALIAN DESIGNED & ENGINEERED

For quality guaranteed

WALL CONTROLLER

FAN ONLY

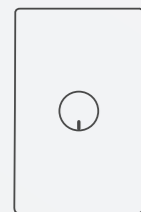

The HPM ceiling sweep fan comes complete with a capacitive 3-speed controller on a wall plate with standard 84mm fixing centres. Please refer to instructions supplied with the speed controller for installation.

FAN WITH LIGHT

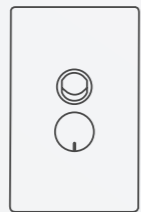

If installing a light, additional components (not supplied) are required. Excel Life 2-gang grid plate [ED770/2GPLWE] Excel Life wall switch [EM770WE]

ED770/1GPLWE



EM3FC



MOUNTING OPTIONS

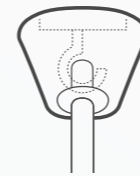

J-HOOK MOUNTING

Suitable for level ceiling only

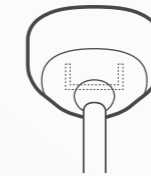

HANG-SURE MOUNTING

Suitable for all ceiling types including inclined ceilings up to a 20° angle

ROD LENGTH

LENGTH	STANDARD		MEDIUM (750mm)		LONG (1500mm)	
	A	B	A	B	A	B
HANGSURE	300mm	345mm	915mm	960mm	1665mm	1710mm
J HOOK	335mm	380mm	950mm	995mm	1700mm	1745mm

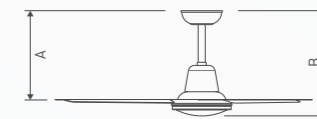

OPTIONAL ACCESSORIES

REMOTE CONTROL KIT*

[CFREMOTEH]

- 2, 4 & 6 hour timer
- Low, Med & High fan speed
- Low, Med & High light
- Compatible with all models
- Wall bracket included

[Note: This remote is not compatible with the Lamp on the RCF Series Fans as the Lamp is non-dimmable. The cable for Fan must be manually wired to the Controller as the connectors are not compatible.]



OYSTER LIGHT KIT

[CFOLWE / CFOLBS]

- Available in White [WE] and Brushed Stainless Steel [BS]
- Compatible with the entire range
- Easy fit-off

[Note: globe not included]



CLIPPER LIGHT KIT

[CFCLWE / CFCLBS]

- Available in White [WE] and Brushed Stainless Steel [BS]
- Compatible with the entire range
- Easy fit-off

[Note: globe not included]



INSPIRE RESIDENTIAL SWEEP SERIES

This ceiling fan is stylish, powerful and tough. With summer and winter reversible option, the inspire series is the perfect companion in any home.



Why 3 or 4 blade?

This is a question of aesthetic preference. Both 3 and 4 blade fans perform equally well.

Main applications

Residential - Living areas, bedrooms, undercover outdoor areas.



Motor Rating	50W
Description	Inspire Residential Ceiling Fan
Number of Blades	4
Construction	Plywood Blades
Mounting	Hang-sure
Diameter	1200mm
Airflow	7680m ³ /h (Max)
Warranty	3 Years
Nominal Input Voltage	230 - 240 V a.c 50Hz

Product codes

	White	RCF12H4WE
	Black	RCF12H4BL
	Brushed Silver	RCF12H4BS

UP TO
MAX AIRFLOW
7,680m³/h

ULTRA QUIET

FAST CONNECT WIRING

3 YEAR WARRANTY



INSPIRE RESIDENTIAL SWEEP WITH LIGHT

NEW

The Inspire fan with light features an integrated LED light for a cleaner, minimalist look. It is ideally suited to smaller rooms where you don't want the visual clutter of separate light fittings.



Main applications

Residential - Living areas, bedrooms, undercover outdoor areas.

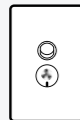

Supplied with Fan Controller with extra switch for light.



Motor Rating	50W
Description	Inspire Residential Ceiling Fan
Number of Blades	4
Construction	Plywood Blades
Mounting	Hang-sure
Diameter	1200m
Airflow	7680m ³ /h (Max)
Warranty	3 Years
Nominal Input Voltage	230 - 240 V a.c 50Hz

Product codes

	White	RCFTRI12H4WE
	Black	RCFTRI12H4BL

LED LIGHT SPECIFICATION

LED Light Output	900 lm
Efficacy	60 lm/W
Wattage	15 W
Colour Temperature	Warm White, Cool White, Natural white.
Colour Rendering Index (CRI)	Ra: 80+

UP TO MAX AIRFLOW 7,680m³/h

ULTRA QUIET

FAST CONNECT WIRING

3 YEAR WARRANTY



INSPIRE SMART SWEEP WITH LIGHT

AVAILABLE FROM
JANUARY 2022

Introducing the latest Inspire Smart fan with integrated LED light. Combining design and engineering with connected technology. Control via your smartphone or remote.



I'm Smart

Control me from your smart phone.

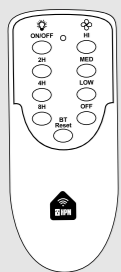

Remote Control (included)

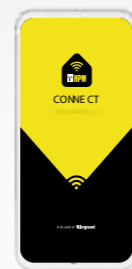
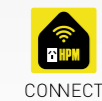

Download the app



Motor Rating	50W
Description	Inspire Smart Sweep fan with light
Number of Blades	4
Construction	Plywood Blades
Mounting	Hang-sure
Diameter	1200m
Airflow	7680m ³ /h (Max)
Warranty	3 Years
Nominal Input Voltage	230 - 240 V a.c 50Hz

Product codes



White

RCFL12H4BTWE

LED LIGHT SPECIFICATION

LED Light Output	900 lm
Efficacy	60 lm/W
Wattage	15 W
Colour Temperature	Warm White, Cool White, Natural white.
Colour Rendering Index (CRI)	Ra: 80+

REMOTE CONTROL (INCLUDED)

- Functions**
- 3 speed control (fan)
 - 3 timer selection (fan)
 - Switch ON/OFF (light)



WHITE ALUMINIUM SERIES

This ceiling fan is unobtrusive and blends into the ceiling. Featuring white aluminium blades, this ceiling fan is excellent for the budget conscious. It's simple, reliable and great value for money.

Main applications
Perfect for residential – commercial – hotels

Why 3 or 4 blade?
This is a question of aesthetic preference. Both 3 and 4 blade fans perform equally well.



RECOMMENDED ACCESSORIES

Clipper Light Kit

Oyster Light Kit

Remote Control Kit

Grid & Plate

Dimmer



CFCLWE (White)



CFOLWE (White)



CFREMOTEH (Hang-sure)



ED770/26PLWE



EM400A3PWE

Recommended when using light kits - insert the fan controller (included in box with fan) and dimmer mechanism in one plate.

Power	60W
Number of blades	3 or 4
Mounting options	J-hook or Hang-sure
Construction	White aluminium blades
Operation	Reversible summer and winter
Inclusions	Excel Life fan controller 3-speed white
Remote controller compatible	J-hook (CFREMOTEJ), Hang-sure (CFREMOTEH)
Light adaptable	LED Clipper light or Oyster light kits available

Product codes	J-hook	Hang-sure
3-blade 900mm		CF9HWE
3-blade 1200mm	CF12JWE	CF12HWE
3-blade 1400mm	CF14JWE	CF14HWE
4-blade 1200mm	CF12J4WE	CF12H4WE
4-blade 1400mm	CF14J4WE	CF14H4WE

UP TO MAX AIRFLOW 11,040m³/h

60W POWERFUL MOTOR

HPM REMOTE COMPATIBLE



FAST CONNECT WIRING



FAN CONTROLLER 3 SPEED

3 YEAR WARRANTY

CF9HWE

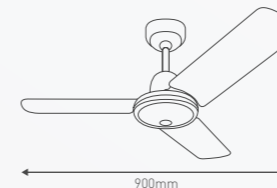

CF12H4WE

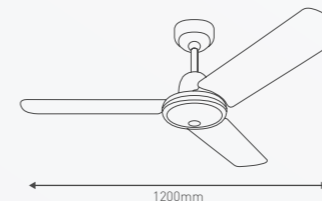

CF14H4WE

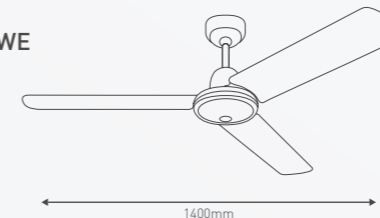

430 STAINLESS STEEL SERIES

These 430 stainless steel ceiling fans have the smart look of stainless steel without the hefty price tag. Featuring quick-fit 430 stainless steel blades for corrosion resistance, this ceiling fan is ideal for budget builds and renovations.



Main applications
Perfect for residential
- commercial - hotels

RECOMMENDED ACCESSORIES

Clipper Light Kit



CFCLBS
(Brushed Stainless Steel)

Oyster Light Kit



CFOLBS
(Brushed Stainless Steel)

Remote Control Kit



CFREMOTEH
(Hang-sure)

Grid & Plate



ED770/26PLWE

Dimmer



EM400A3PWE

Recommended when using light kits - insert the fan controller (included in box with fan) and dimmer mechanism in one plate.

Power	60W	
Number of blades	3	
Mounting options	J-hook or Hang-sure	
Construction	Stainless steel blades	
Operation	Reversible summer and winter	
Inclusions	Excel Life fan controller 3-speed white	
Remote controller compatible	J-hook (CFREMOTJ), Hang-sure (CFREMOTEH)	
Light adaptable	LED Clipper light or Oyster light kits available	
Product codes	J-hook	Hang-sure
	3-blade 900mm	CF9HBS
	3-blade 1200mm	CF12HBS
	3-blade 1400mm	CF14JBS CF14HBS

CF9HBS

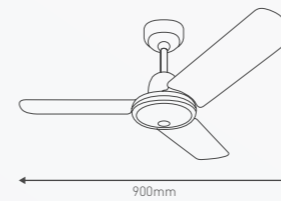

CF12HBS

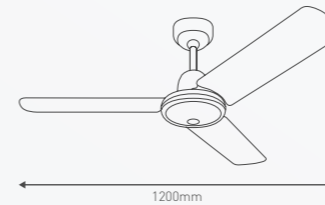

CF14HBS

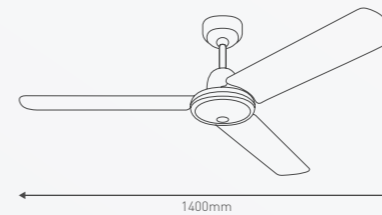

UP TO
MAX
AIRFLOW
11,040m³/h

60W
POWERFUL
MOTOR

HPM
REMOTE
COMPATIBLE



FAST
CONNECT
WIRING



FAN
CONTROLLER
3 SPEED

3 YEAR
WARRANTY



ACCESSORIES

	CAT NO	FINISH	DIAMETER (MM)
Light Kits	CFOLWE	White	245mm
	CFOLBS	Brushed Stainless Steel	245mm
	CFCLWE	White	190mm
	CFCLBS	Brushed Stainless Steel	190mm

	CAT NO	MOUNTING	FINISH	LENGTH
Downrods	CFDR750HWE	Hang-sure	White	750mm
	CFDR750HBS	Hang-sure	Brushed Stainless Steel	750mm
	CFDR1500HWE	Hang-sure	White	1500mm
	CFDR1500JWE	J-Hook	White	1500mm

	CAT NO	DESCRIPTION
Remote Control	CFREMOTEH	Remote control kit for Hang-sure Ceiling Fans

RANGE OVERVIEW

	CAT NO	DIAMETER (MM)	MOUNTING	FINISH	BLADES	MAXIMUM AIRFLOW (M ³ /H)	RPM HIGH / MEDIUM / LOW
Inspire Ceiling Fans	RCF12H4WE	1200	Hang-sure	White	4	7,680	H225, M160, L100
	RCF12H4BL	1200	Hang-sure	Black	4	7,680	H225, M160, L100
	RCF12H4BS	1200	Hang-sure	Brushed Silver	4	7,680	H225, M160, L100
	RCFTRI12H4WE	1200	Hang-sure	White	4	7,680	H225, M160, L100
	RCFTRI12H4BL	1200	Hang-sure	White	4	7,680	H225, M160, L100
	RCFL12H4BTWE	1200	Hang-sure	White	4	7,680	H225, M160, L100
Aluminium Series	CF9HWE	900	Hang-sure	White	3	4,920	H360, M260, L160
	CF12HWE	1200	Hang-sure	White	3	10,020	H320, M260, L150
	CF12JWE	1200	J-Hook	White	3	10,020	H320, M260, L150
	CF12H4WE	1200	Hang-sure	White	4	10,800	H290, M220, L125
	CF12J4WE	1200	J-Hook	White	4	10,800	H290, M220, L125
	CF14HWE	1400	Hang-sure	White	3	11,040	H280, M210, L115
430 Stainless Steel Series	CF14JWE	1400	J-Hook	White	3	11,040	H280, M210, L115
	CF14H4WE	1400	Hang-sure	White	4	11,880	H255, M185, L105
	CF14J4WE	1400	J-Hook	White	4	11,880	H255, M185, L105
	CF9HBS	900	Hang-sure	430 Stainless Steel	3	4,920	H360, M260, L160
	CF12HBS	1200	Hang-sure	430 Stainless Steel	3	10,020	H320, M260, L150
	CF14HBS	1400	Hang-sure	430 Stainless Steel	3	11,040	H280, M210, L115
	CF14JBS	1400	J-Hook	430 Stainless Steel	3	11,040	H280, M210, L115



A brand of **legrand**



Legrand Australia

Building 4 Nexus Industry Park
43-47 Lyn Pde Prestons NSW 2170
1300 369 777

www.hpm.com.au

Legrand New Zealand

106-124 Target Road Glenfield
Auckland 0627 New Zealand
0800 476 009

www.hpm.co.nz

Disclaimer: The information provided in this document is intended for informational purposes only. It has been prepared and reviewed with all reasonable care and is believed to be correct at the time of printing. Legrand Australia and New Zealand may also make improvements and/or changes to the products, pricing and/or programs described in this brochure at any time without notice.