

Arteor™











Micro-switch without neutral 400 W / 全负载400W小按钮开关

5740 04/54 - 5743 04/54



	White / 白色	Magnesium / 镁白色	White / 白色	Magnesium / 镁白色
	5740 04	5740 54	5743 04	5743 54

LE01816AB

						
100 - 240 V 50/60 Hz	2 x 1.5 mm ²					
240 V	Max.	400 W	400 W	400 VA	400 VA	
	Min.	40 W	40 W	40 VA	40 VA	
100 V	Max.	200 W	200 W	200 VA	200 VA	
	Min.	20 W	20 W	20 VA	20 VA	

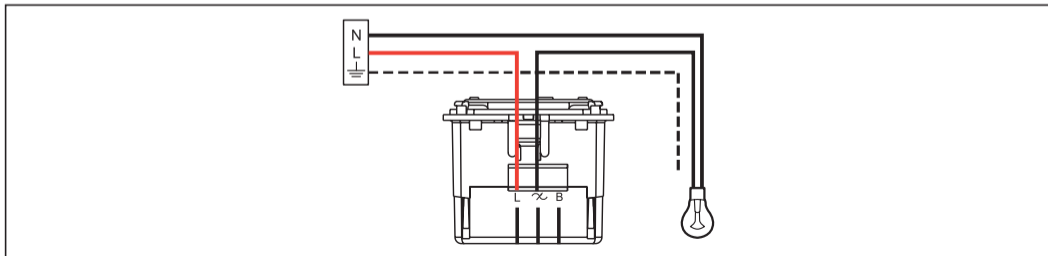

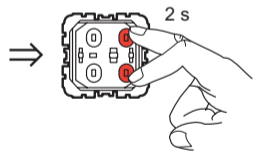
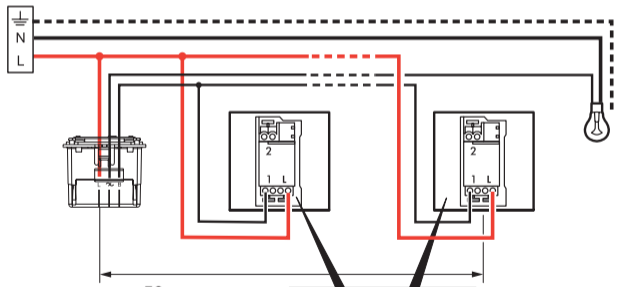
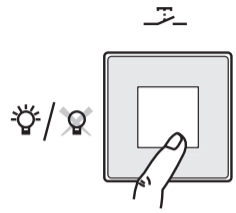
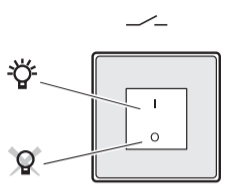
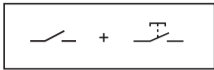

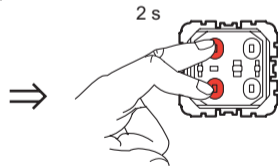
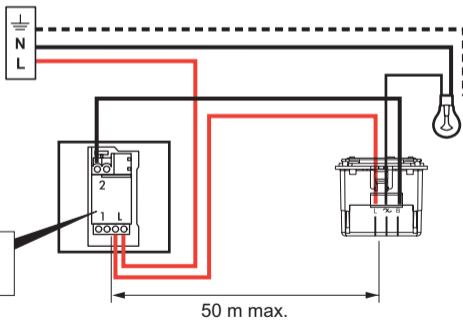
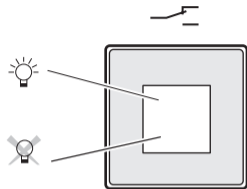
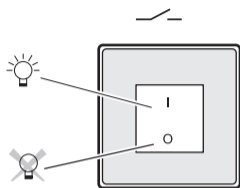
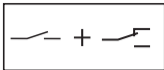

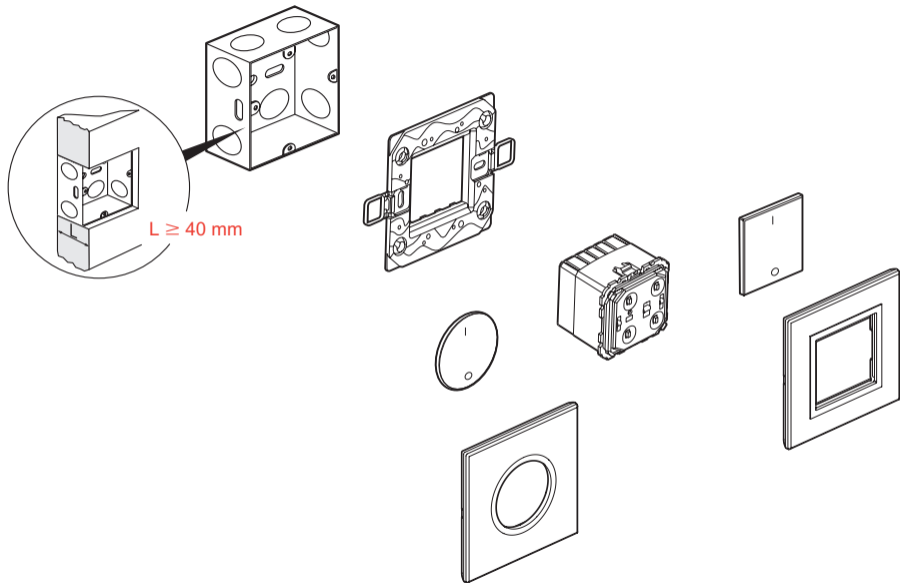

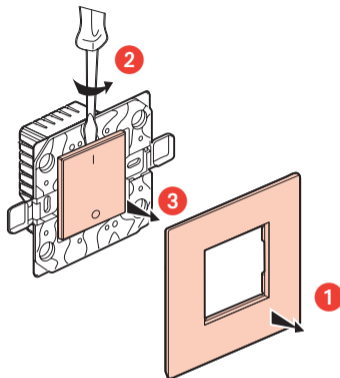
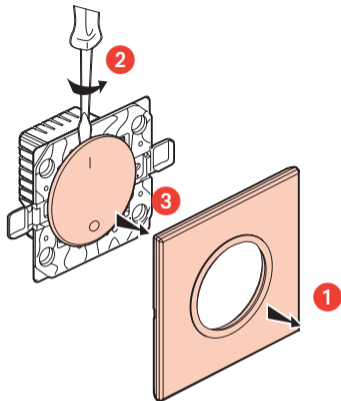

Safety instructions

This product should be installed in line with installation rules, preferably by a qualified electrician. Incorrect installation and use can lead to risk of electric shock or fire.

Before carrying out the installation, read the instructions and take account of the product's specific mounting location.

Do not open up, dismantle, alter or modify the device except where specifically required to do so by the instructions. All Legrand products must be opened and repaired exclusively by personnel trained and approved by Legrand. Any unauthorised opening or repair completely cancels all liabilities and the rights to replacement and guarantees.

Use only Legrand brand accessories.



安全提示

本产品的安装要满足规范的要求，最好由持证电工完成，不正确的安装和使用会有触电或火灾的风险。在安装前，请仔细阅读本手册的内容并充分考虑产品的具体安装位置。

除非本手册有特别要求，切勿打开、拆卸、改动本装置。所有罗格朗的产品必须由专门受过培训并得到罗格朗批准的专人打开和修理，任何擅自打开或修理，本公司概不负责更换和质量保证。

只能使用罗格朗的附件。



Arteor™

مفتاح صغير بدون محايد، أبيض 400 واط

5740 04/54 - 5743 04/54

 **legrand**®

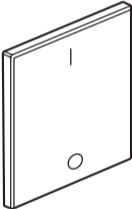
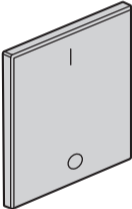
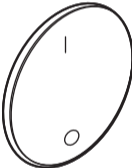
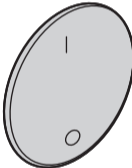
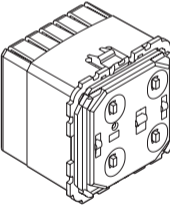
				
أبيض	مغنيزيوم	أبيض	مغنيزيوم	
5740 04	5740 54	5743 04	5743 54	

					$2 \times 2.5 \text{ م}^2$	فولط 240-100 هرتز 60-50
	400 واط	400 واط	400 فولط أمبير	400 فولط أمبير	حد أقصى	240 فولط ~
	40 واط	40 واط	40 فولط أمبير	40 فولط أمبير	حد أدنى	
	200 واط	200 واط	200 فولط أمبير	200 فولط أمبير	حد أقصى	100 فولط ~
20 واط	20 واط	20 فولط أمبير	20 فولط أمبير	حد أدنى		

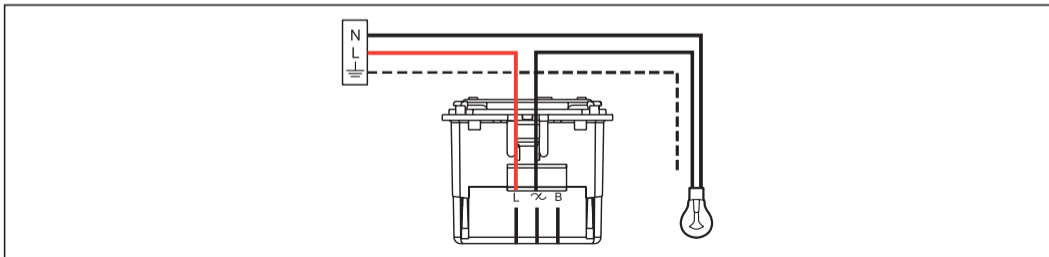

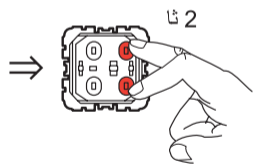
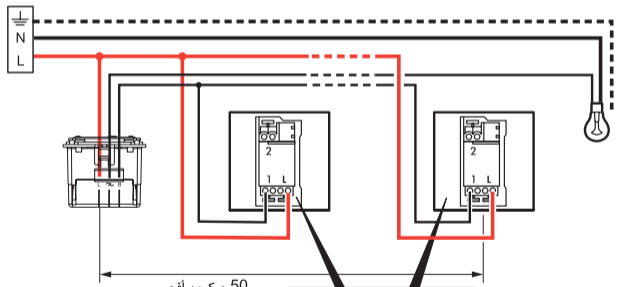
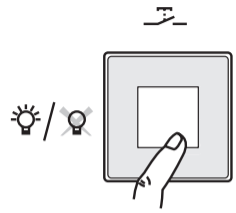
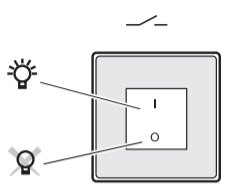
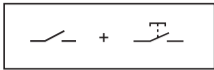

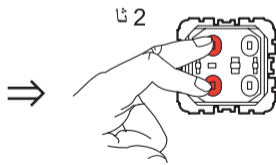
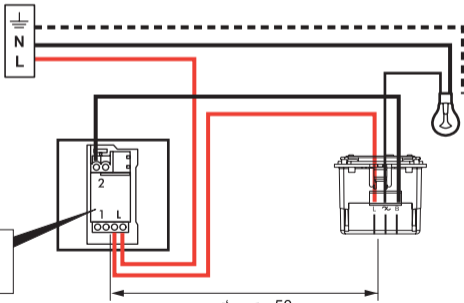
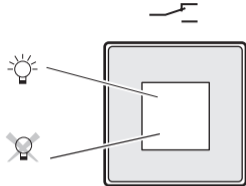
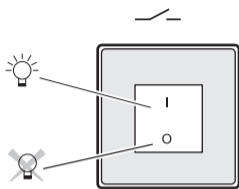
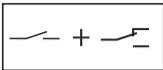

50 م كحد أقصى

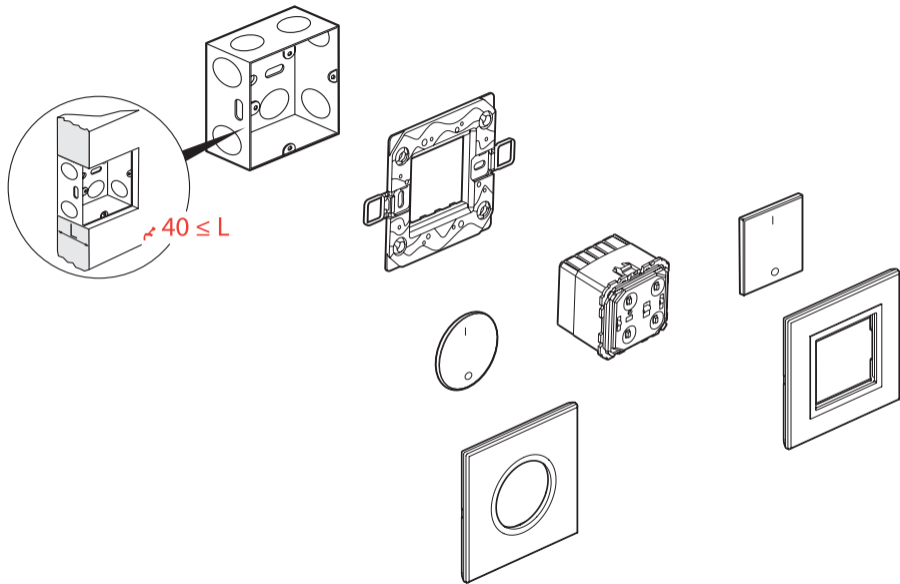

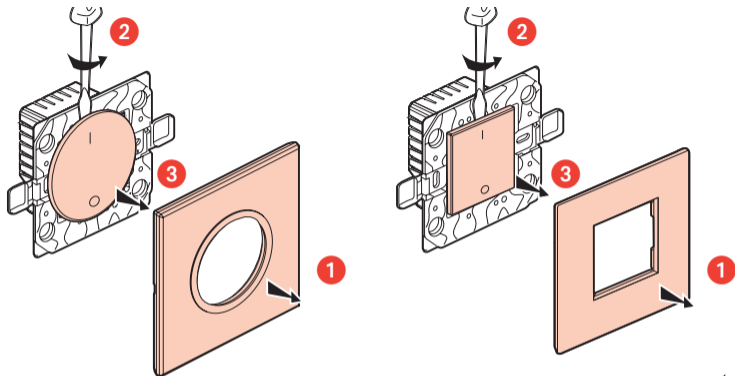

⚠ إرشادات الأمان:

يجب تركيب هذا المنتج طبقاً لقواعد التركيب ويفضل أن يقوم بالتركيب كهربائي مؤهل. فقد يؤدي التركيب والاستخدام غير الصحيح إلى مخاطر التعرض لصدمة كهربائية أو نشوب حريق. اقرأ النشرة قبل التركيب. وأفرّد مكاناً لتركيب المنتج خاصاً به.

لا تفتح أو تفك أو تعدّل أو تحوّر المنتج ما لم يُشر إلى ذلك بشكل محدد في النشرة. فكل منتجات Legrand يجب فتحها وإصلاحها حصراً من قبل فنيين مدربين ومؤهلين لدى Legrand. وكلّ فتح أو إصلاح غير مسموح به يُبطل المسؤوليات وحقوق الاستبدال والضمانات.

لا تستخدم سوى إكسسورات من ماركة Legrand حصراً.