

Temperature control unit

5739 18/19

Installation manual



Contents

1 - Introduction	5
1.1 - Warnings and tips	5
1.2 - Contents of package	5
2 - Description of the Control unit	6
2.1 - Overview	6
2.2 - Display	7
2.3 - Navigation keys	8
2.4 - Main functions	9
2.5 - Mode of operation	9
2.6 - Factory settings	10
3 - Installation	11
3.1 - Rear view of the Control Unit	11
3.2 - Connecting the battery	12
3.3 - Installing the unit	12
4 - Switching on for the first time	13
4.1 - Selecting the language	13
4.2 - Learning the zones	14
4.3 - Configuring the zone actuators	15
4.4 - Configuring the pumps	17
4.5 - Setting the Date and Time	19
4.6 - Setting the Summer/Winter system	20
5 - Programming	21
5.1 - Programming from personal computer	21
6 - Main menu	22
6.1 - Mode	25
6.2 - Zone state	33
6.3 - Current profiles	34
6.4 - Programming	35
6.4.1 - Weekly	36
6.4.2 - Scenarios	46
6.4.3 - Holiday	51
6.5 - Setup	55
6.5.1 - Temperatures	56
6.5.2 - Summer/Winter	57
6.5.3 - Date/time	58
6.5.4 - Remote control	59
6.5.5 - User code	60
6.5.6 - Contrast	61
6.5.7 - Diagnostic	62
6.6 - Probes	65

Contents

6.7 - Contacts management	66
6.8 - Chiller	67
6.9 - Maintenance	68
6.9.1 - Language	69
6.9.2 - Configure zone	70
6.9.3 - Probe setting	79
6.9.4 - System test	80
6.9.5 - Maintenance code	81
6.9.6 - Total reset	82
6.9.7 - Automations	83
Appendix	84
Troubleshooting	85
Note	86

1 - Introduction

1.1 - Warnings and tips

Before proceeding with the installation this manual should be read carefully, because the guarantee is automatically cancelled in the event of negligence, incorrect manoeuvre or improper use or if unauthorised people tamper with the circuit.

Moreover it is cancelled when the fault is due to strong accidental overvoltages on the power supply network. Thus if the Control Unit is installed in a place which is subject to violent atmospheric discharges (storms), suitable protection must be installed on the power supply line and it must be connected to the earth as rigorously as possible and respecting IEC standards.

1.2 - Contents of package

The Control unit package contains:

- Temperature control unit 5739 18/19.
- Installation manual.
- User manual.
- CD-ROM containing ThermoConfig software and manuals in PDF format.

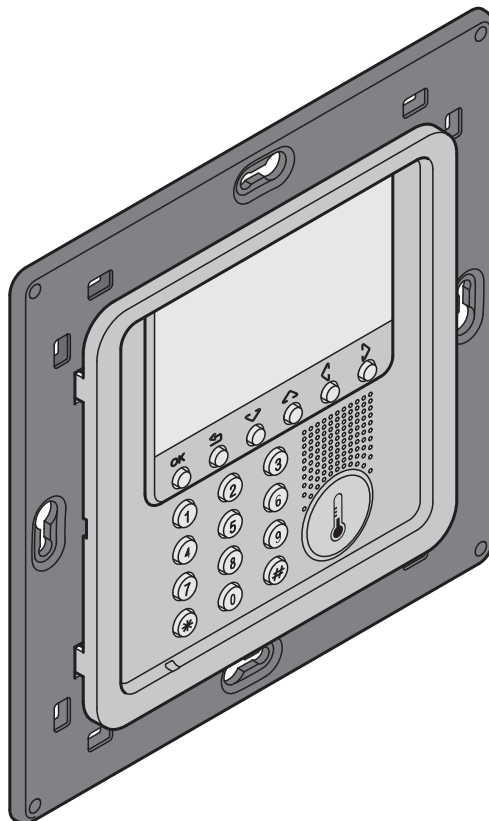

2 - Description of the Control unit

2.1 - Overview

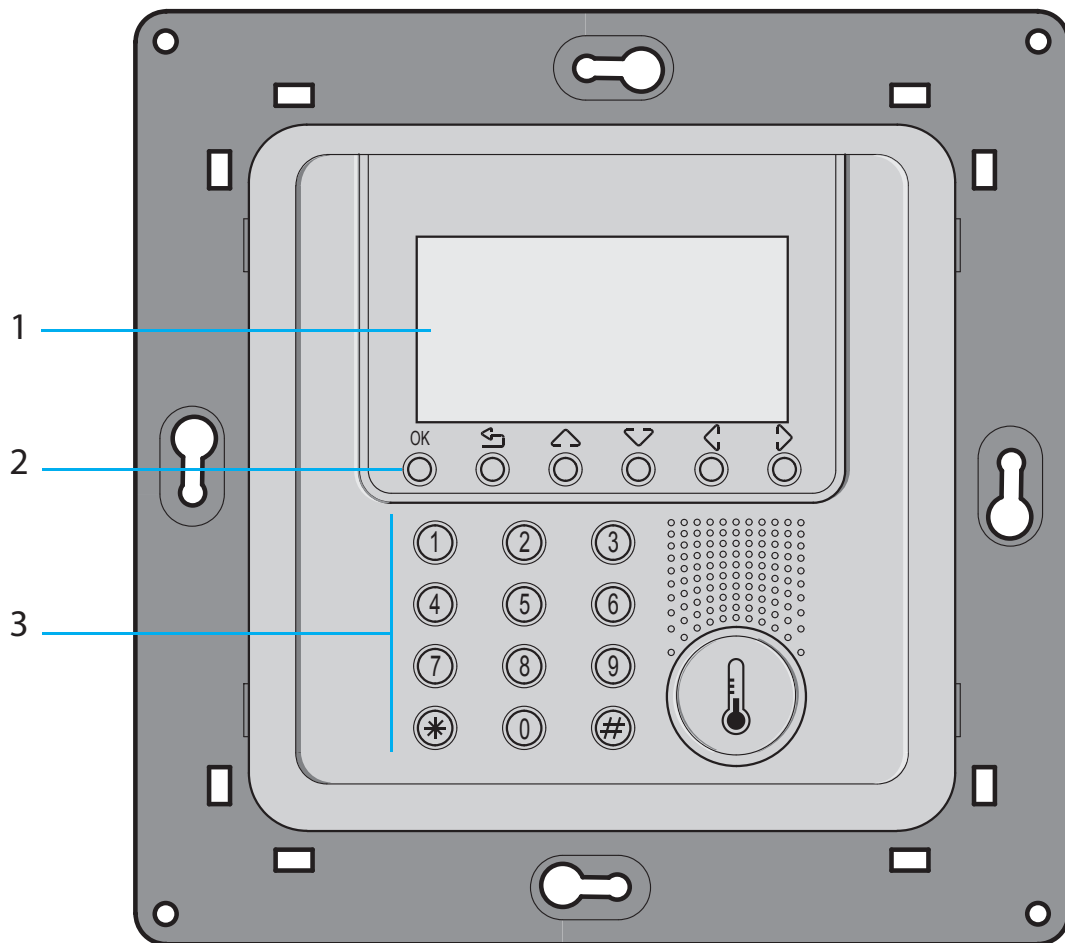

- 1 Graphic display:** displays the messages which guide the programming operations and the events which have occurred (*more information on the next page*).
- 2 Navigation keypad:** lets you navigate through the menus and enables the confirmation or cancellation of programming operations.
- 3 Alphanumeric keypad:** allows manual entering of all programming operations that require the use of numbers and/or symbols.

2 - Description of the Control unit

2.2 - Display

First page

In normal operation the Control Unit display shows the following information in the first page:

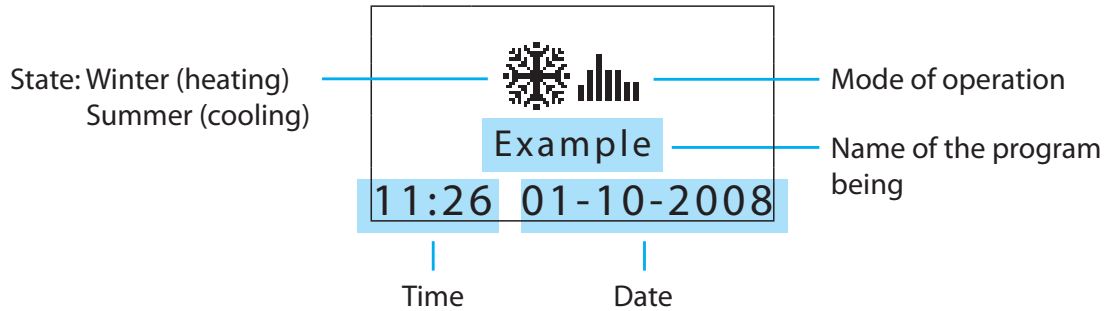

The system automatically returns to the first page after 2 minutes time-out.

Mode of operation:

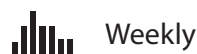

Weekly



Holiday



Manual



OFF



Scenarios



Antifreeze or Heatprotection

In normal operation, when one of the following modes is set for some zones of the system, the Control Unit display will show their icons in the first page:

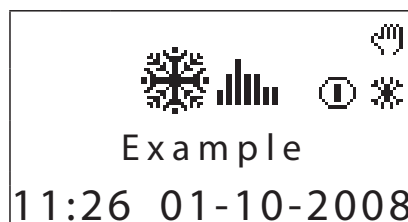

One or more zones in OFF



One or more zones in MANUAL



One or more zones in ANTIFREEZE or HEAT protection

When a mode is applied to ALL THE ZONES of the system the following information is given on the control unit display:

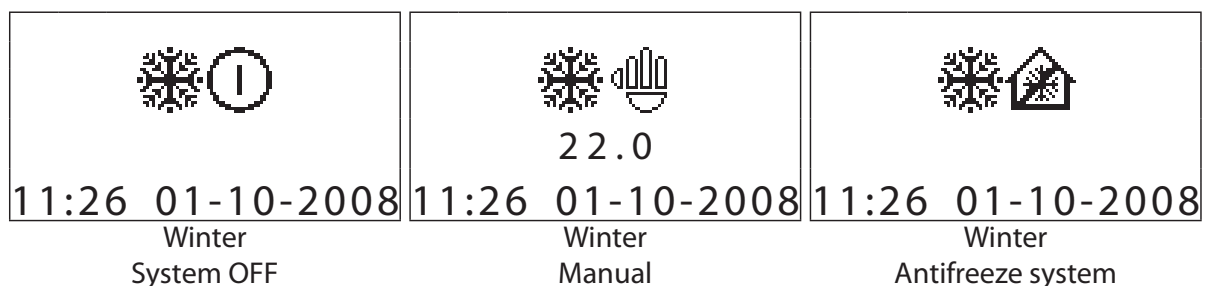

2 - Description of the Control unit

Fault signalling

In normal operation, when one of the following modes is set for some zones of the system, the Control Unit display will show their icons in the first page:

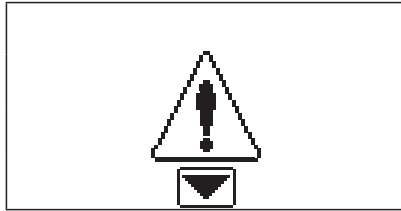

The page indicates a system fault; press any key for direct access to the Diagnostics menu.



! The icon indicates an operation fault in one or more system zones.



Flat battery

2.3 - Navigation keys



OK - Key to confirm the selection displayed or the data entered.

↶ - Key to cancel the selection and return to the previous page – keep pressed to quit the Main menu and return to the first page.



Scroll keys, scrolls the list of items in the menu.



Selection keys, can select functions when they are present in the menu.

01:	Weekly
02:	Manual
03:	Scenarios
04:	Scenarios

01:	Zone1
02:	Zone2
03:	Zone3
Manual	

2 - Description of the Control unit

2.4 - Main functions

Control Unit 5739 18/19, which can only be used for the In One by Legrand® temperature control function, can set the system and modify the mode of operation. Coming with management software with guided menus shown on the display, it lets the user select the mode of operation, display the temperatures of the individual zones and display and change the daily temperature profiles and the weekly programs, while the maintenance menu, reserved for the installer (code protected), gives access to the system settings (zone configuration, system test, total reset...). The Control Unit can manage heating and cooling systems up to a maximum of 99 zones. An input contact can be connected for the remote control (switching from antifreeze mode to automatic mode and vice versa) by telephone actuator

2.5 - Mode of operation

7 different modes of operation can be selected:

- **Weekly**
3 weekly programs can be created for each of the two functions (heating and cooling); daily temperature profiles (0h – 24h), different for each day of the week and for each zone, can be defined for each of these.
- **Manual**
In this mode a fixed temperature can be set on the whole system and on the individual zone without time bands; for the individual zone, when the manual mode is switched off operation is automatically reset on the last programming set.
- **Scenarios**
In this mode scenarios can be defined which the user activates as required; these scenarios set a predefined temperature in the various zones. Up to 16 scenarios can be defined for winter operation and 16 for summer operation and for each of these the temperature to be set is associated with each zone.
- **Holiday**
The Holiday mode can select a particular daily profile for a set period. The program is run until the date and time programmed, after which the weekly program selected is reset.
- **Holidays**
This mode keeps the system in Antifreeze or Heat protection until the date and time set. At the end the weekly program selected is reset.
- **OFF**
When this mode of operation is entered the Control Unit switches off all the selected zones until one of the other modes is reset.
- **Antifreeze / Heat protection**
In this mode the system sets the antifreeze or heat protection temperature on the whole system or on the individual zone on the basis of the current system function (summer/ winter).

2 - Description of the Control unit

2.6 - Factory settings

The temperature control unit is supplied with the following settings:

User code	00000 (DISABLED)
Maintenance code	12345
Language	ENGLISH
Mode	WEEKLY
Program	EXAMPLE (preset)
State	WINTER
Temperatures	Winter : T*: 7.0°C - T1: 18.0°C - T2: 20°C - T3: 22°C Summer: Pt: 35.0°C - T1: 20.0°C - T2: 23°C - T3: 25°C
Remote control	ENABLED

3 - Installation

3.1 - Rear view of the Control Unit

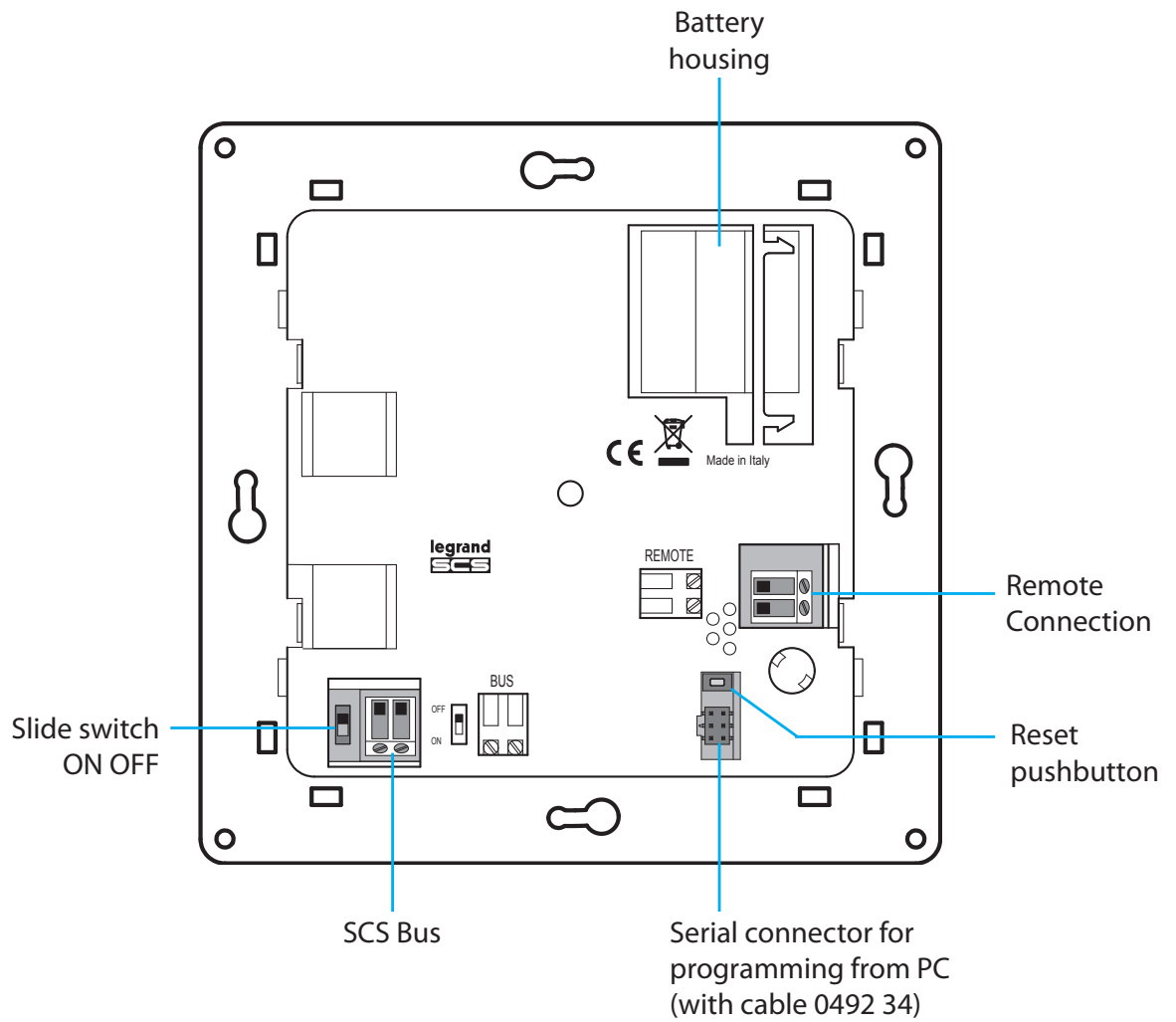

3 - Installation

3.2 - Connecting the battery

Connect the battery to the connector respecting the polarities indicated inside the housing.

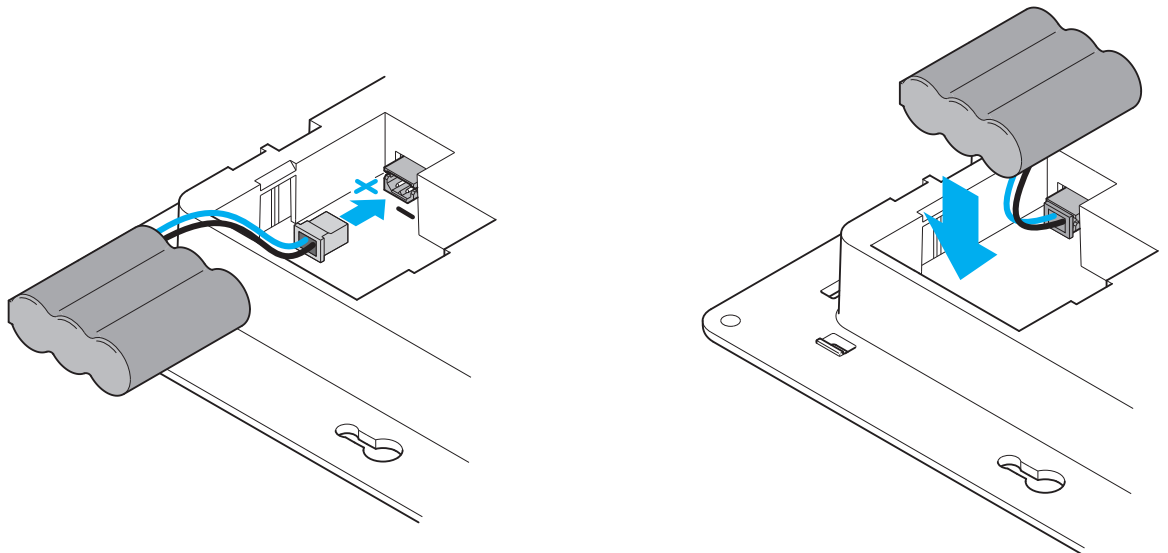

3.3 - Installing the unit

After making all connections, fasten the Unit to the base. Be careful not to damage the wires.

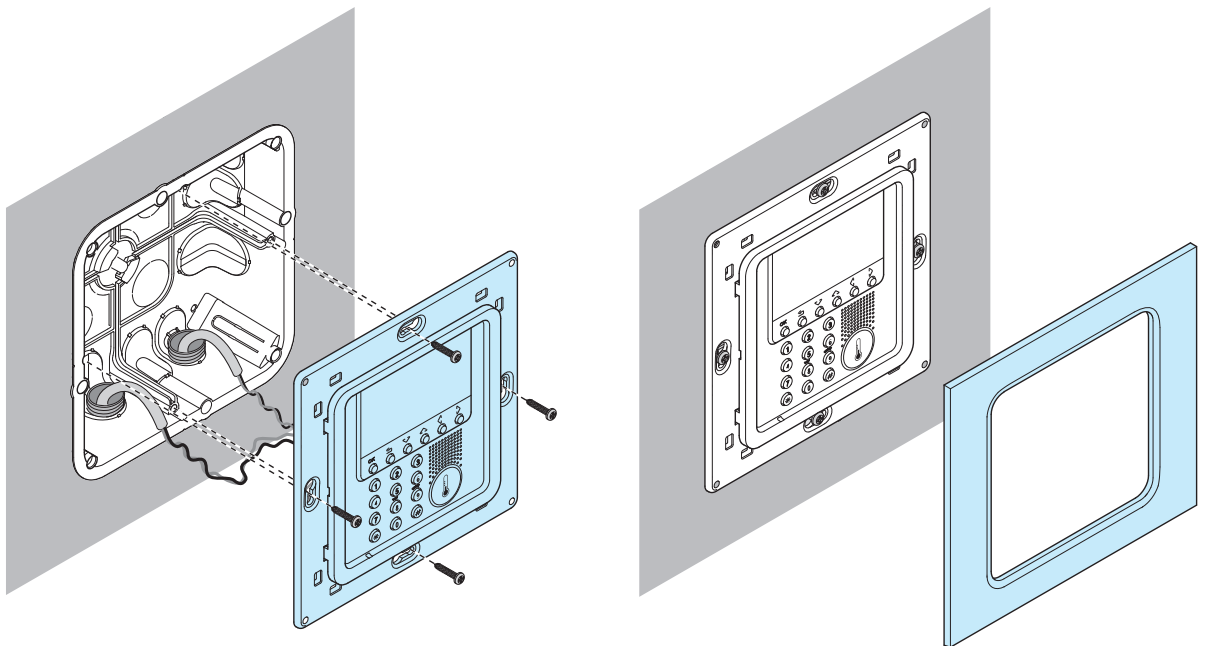

4 - Switching on for the first time

When the Control Unit is switched on for the first time it shows the Maintenance menu with the **Language** function highlighted.

To activate the Control Unit and make it operational:

- Select the **Language**.
- Perform the zone learning - **Zone search**.
- Configure the zone **Actuators**.
- Configure the zone **Pumps**.
- Enter time and date.
- Define the system state (Summer/Winter).

4.1 - Selecting the language

Use this function if the language preset in the factory is not that required:

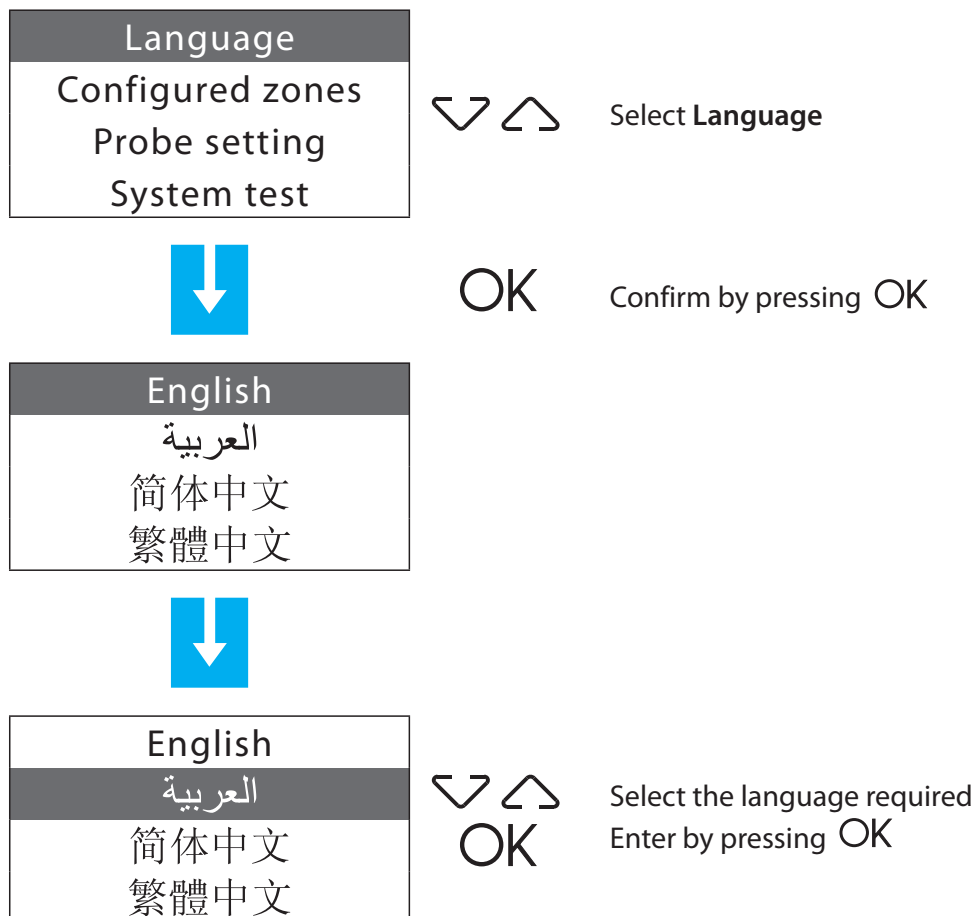

4 - Switching on for the first time

4.2 - Learning the zones

This function lets the Control Unit recognise all the system zones.

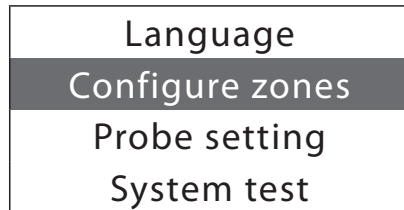

Select **Configures zones**



OK

Confirm by pressing OK



The Control Unit signals "No zone configured" and that the "Zone search" can be performed



OK

Confirm by pressing OK

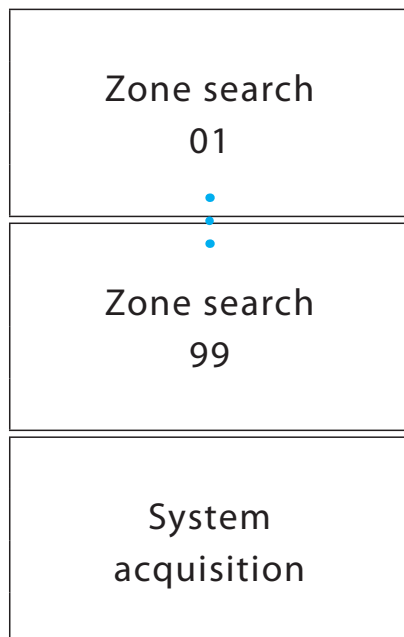

The Control Unit searches the zones from 1 to 99. Depending on the size of the system, this operation may take a few minutes



When the search is completed it returns to the Configure zones menu

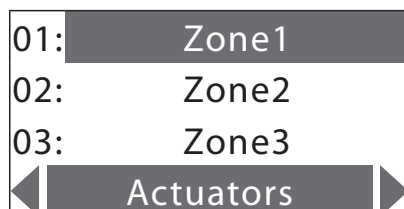

4 - Switching on for the first time

4.3 - Configuring the zone actuators

This function completes the zone configuration, indicating:

- which actuators are installed for Heating;
- which actuators are installed for Cooling;
- which type of load the zone manages.



Only perform with Standard configuration (see Technical Guide)

01:	Living room
02:	Zone2
03:	Zone3
◀ Actuators ▶	



Select the **zone** (e.g. Living room)



OK

Confirm by pressing OK

01:	Heating
02:	Heating
03:	Cooling
◀ Not connected ▶	



One of the following options can be selected for each actuator in the list:

◀ Not connected ▶	
◀ Heating ▶	
◀ Cooling ▶	
◀ Heat. & cool. ▶	

Not present on the system

Is used to manage the Heating system

Is used to manage the Cooling system

Is used to manage both the Heating system and the Cooling system (e.g.: 2-pipe fan coil)



OK

Confirm by pressing OK

09:	Not connected
H:	ON/OFF
C:	OPEN/CLOSE
◀ FAN-COIL 3V ▶	



The last two items of the menu can select the type of load managed



NEXT

4 - Switching on for the first time



09: Not connected
 H: ON/OFF
 C: OPEN/CLOSE
 FAN-COIL 3V



One of the following options can be selected for each operation:

FAN-COIL 3V
 ON/OFF
 OPEN/CLOSE
 GATEWAY

Fan-coil with control of one valve and selector switch up to 3 speeds

Load managed by just one contact (e.g. thermostatic valve)

Load managed by two interlocked relays (e.g.: motor-driven valve with opening contact and closing contact)

Interface for Climaveneta Fan-coil



On pressing the key the configuration set is sent to the zone

Zone test ...



01: Living room
 02: Zone2
 03: Zone3
 Pumps



When the zone is configured press twice to return to the Main Menu

Current profiles
 Programming
 Setup
 Maintenance

4 - Switching on for the first time

4.4 - Configuring the pumps

Can complete the zone configuration, indicating which pumps must control the zone and with how much delay.



This function can only be used if the probe is configured with the CEN configurator in socket P.

01:	Living room
02:	Zone2
03:	Zone3
Pumps	



Select the **Zone** (e.g.: Living room)



OK

Confirm by pressing OK

01:	Heating
02:	Heating
03:	Cooling
Not connected	



One of the following options can be selected for each actuator in the list:

Not connected	
Heating	
Cooling	
Heat. & cool.	

Not present on the system or not managed by the zone selected

Is used to manage the Heating system

Is used to manage the Cooling system

Is used to manage both the Heating system and the Cooling system



OK

Confirm by pressing OK

09:	Not connected
H:	1
C:	0
0	



The last two items of the menu can select the delay in activating the pump



Selects the minutes of delay



OK

Press OK to confirm

NEXT

4 - Switching on for the first time



Zone test . . .



01:	Living room
02:	Zone2
03:	Zone3
Pumps	



On pressing the  key the configuration set is sent to the zone.

The control unit sends the configuration:

The following error message may be given

ERROR
Verify the
probe
configuration

Make sure that the probe is in configuration (P = CEN) and try again; if it is not in this configuration, it cannot be configured via the control unit

4 - Switching on for the first time

4.5 - Setting the Date and Time

Setting the Date/Time correctly is important for correct running of the set weekly programs.

<p>Zone state Current profiles Programming Setup</p>		Select Setup
	OK	Confirm by pressing OK
<p>Temperature Summer/Winter Date/Time Remote control</p>		Select Date/Time
	OK	Confirm by pressing OK
<p>Time 06 : 27 Date 01 / 10 / 08</p>		Type current Time and Date
		The keys move the selection by one digit
<p>Time 11 : 30 Date 05 / 11 / 08</p>		The keys change the Time/Date line and vice versa
	OK	Confirm by pressing OK
<p>Temperature Summer/Winter Date/Time Remote control</p>		

4 - Switching on for the first time

4.6 - Setting the Summer/Winter system

Sets the mode of operation of the Cooling or Heating system.



Before performing the switching, perform all the operations necessary for the hydraulic system to work correctly.



Select **Summer/Winter**



OK

Confirm by pressing OK



The display indicates the current state: Winter



OK

Confirm by pressing OK



A BEEP signal that the modification has been made

The display indicates the new setting: Summer



After the switching the system is set on Antifreeze/Heat Protection mode.

5 - Programming

5.1 - Programming from personal computer

Type of program

The Unit can be programmed by using the ThermoConfig software.

Programming from a PC requires a cable 0492 34, for the connection between the Unit 6-way connector and a PC USB port.

Connection is carried out as follows:

Use the maintenance code to enter the **Maintenance** using the Maintenance menu, take the Unit OFF the bracket.

Start **ThermoConfig** program.

Connect cable when requested and then follow the program procedure

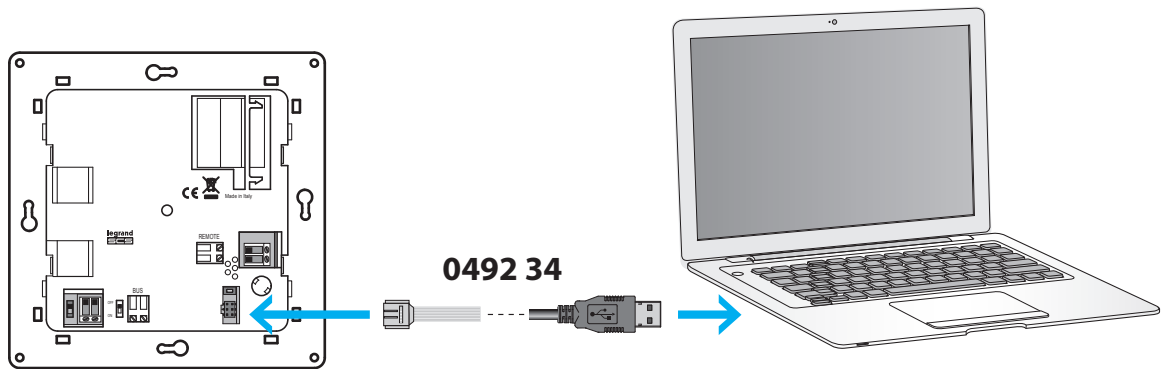

For further information, see ThermoConfig software manual.

Firmware update

This function allows updating the Unit software with its latest release. Such update allows bringing in improvements as well as new Unit functions.

The latest firmware releases are available at www.legrandelectric.com



Before starting the firmware updating procedure position the slide switch on OFF

For further information, see ThermoConfig software manual.

6 - Main menu

Access to the Main Menu

After performing the operations described in the “Switching on for the first time” chapter, you can access the programming menus to perform a wide series of customisations which can exploit the features of the Temperature control unit to the full and satisfy user requirements.

There are two programming levels:

- **level 1** (user), gives access to all the menus apart from the **Maintenance menu**, where there are functions which are reserved to the installer or an expert user.
Access to the user level can be protected by the **User code** (default disabled).
- **level 2** (installer), gives access to all the menus.
Access to the installer level requires the **Maintenance code** (default 12345).



When the access codes are modified, they should be given in the boxes below.

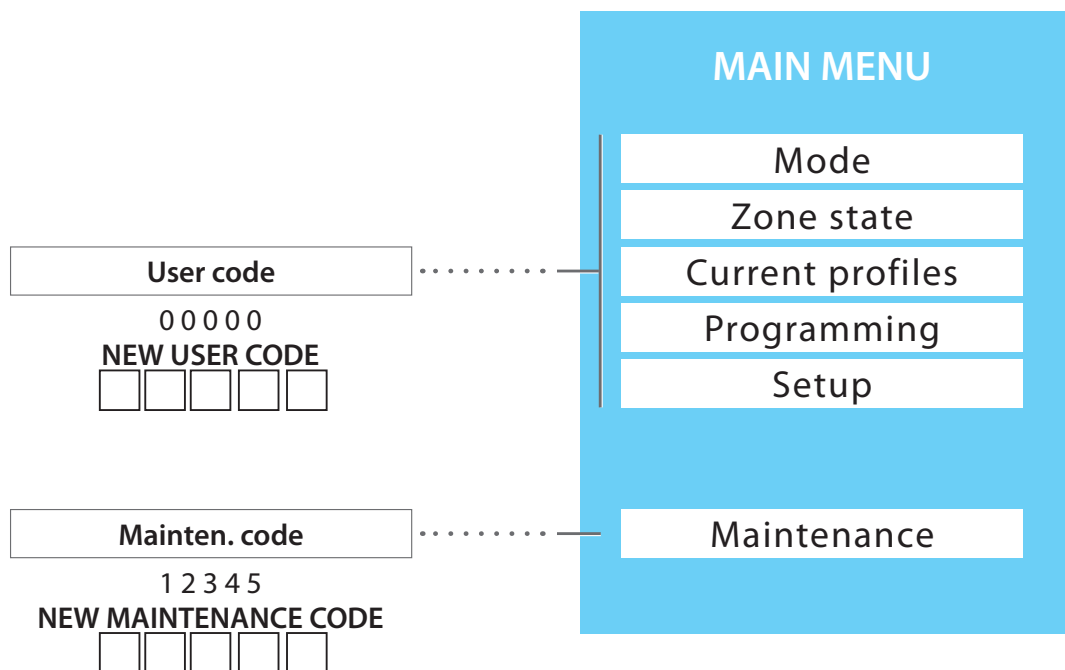

To quit the Main Menu wait for 2 minutes without pressing any key or press the ↩ key.

6 - Main menu

Main Menu tree

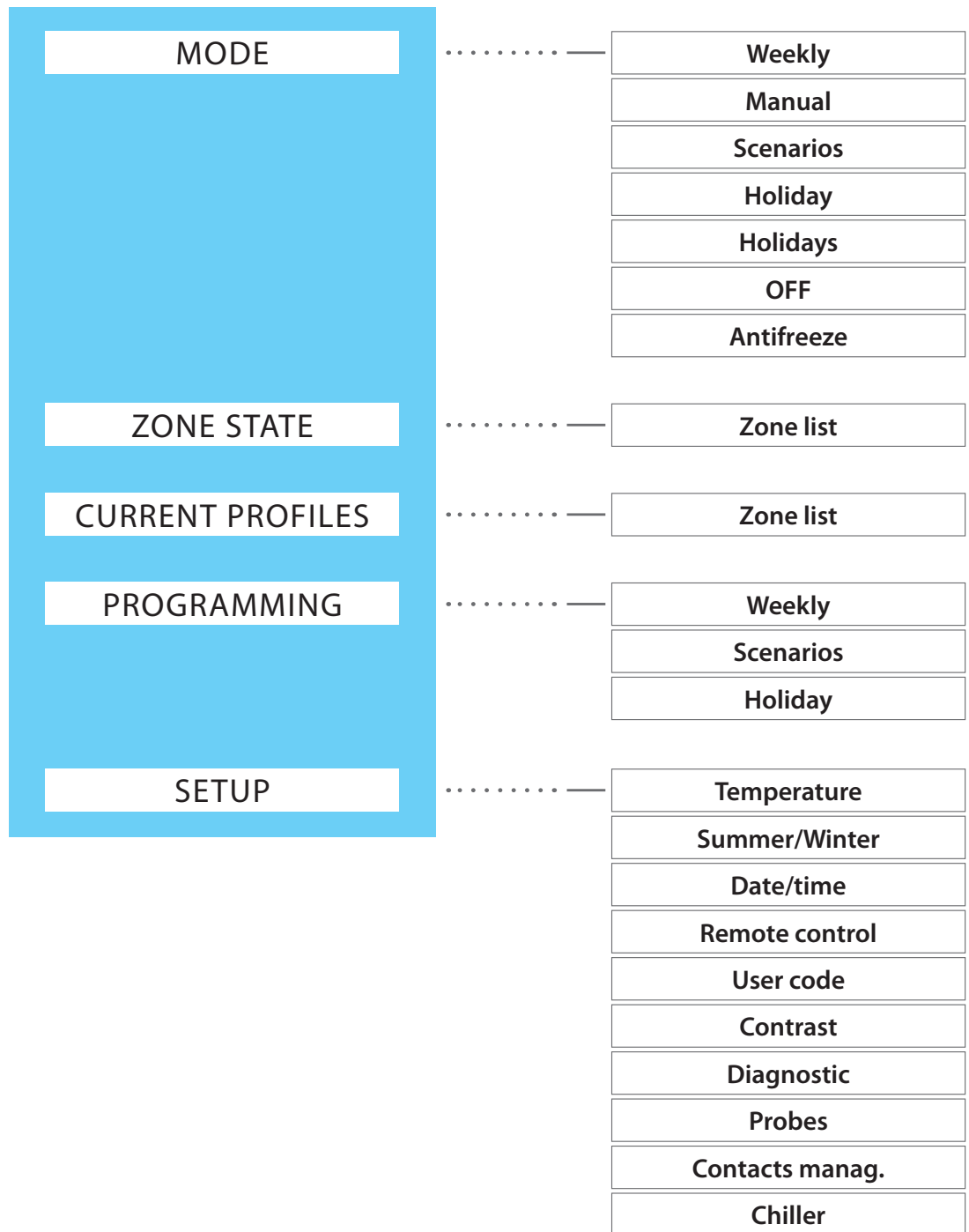

To quit the Main Menu wait for 2 minutes without pressing any key or press the  key.

6 - Main menu

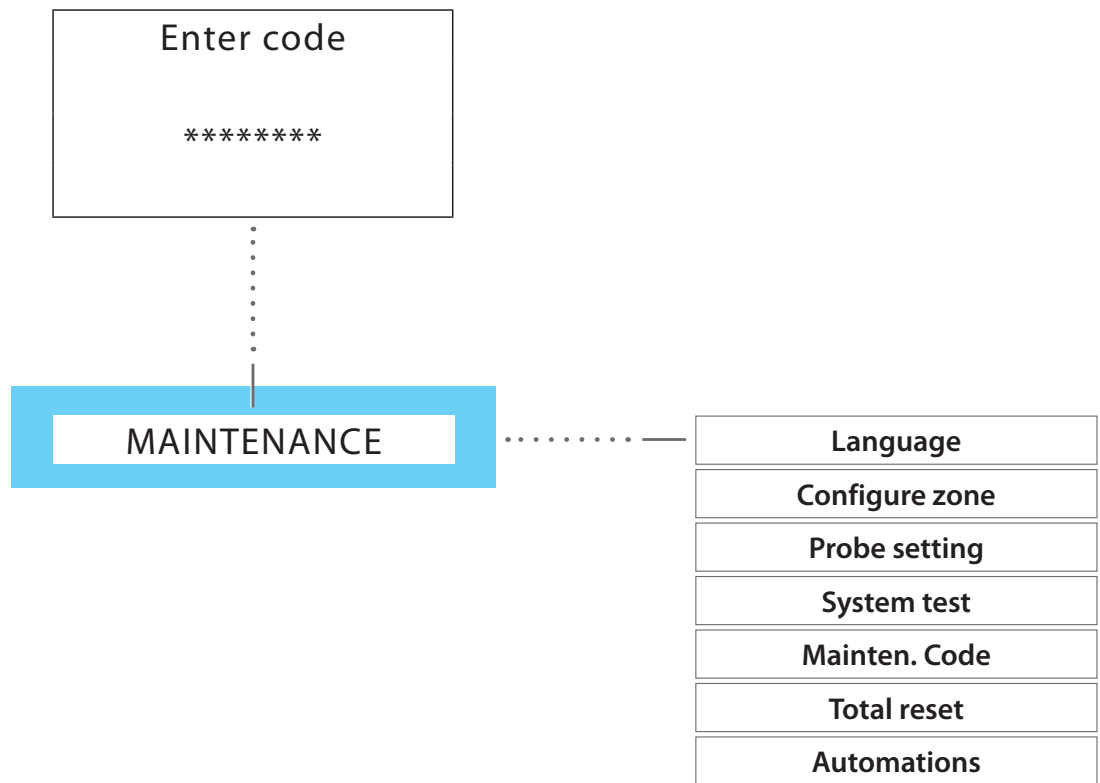

To quit the Main Menu wait for 2 minutes without pressing any key or press the ↵ key.

6 - Main menu



6.1 - Mode

This mode can select the mode of operation in every zone of the system; the active modes are identified by the highlighted identification code.

Active zones —

01:	Weekly
02:	Manual
03:	Scenarios
04:	Holiday

To access the **Mode menu**:

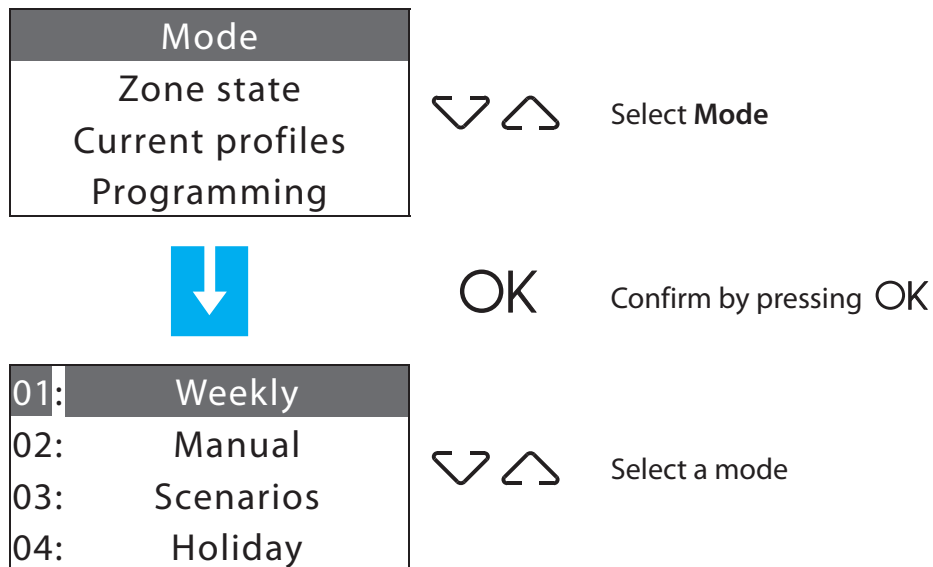

Modes of operation:

- 1 Weekly** - 3 Winter programs, 3 Summer programs.
- 2 Manual** - fixed temperature on the whole system or the individual zone.
- 3 Scenarios** - 16 Winter scenarios and 16 Summer scenarios.
- 4 Holiday** - "Holiday" program for each zone.
- 5 Holidays** - system in antifreeze or heat protection until the date and time set.
- 6 OFF** - one or more zones in OFF.
- 7 Antifreeze** - one or more zones in Antifreeze or Heat protection.

6 - Main menu



6.1.1 - Weekly

Can set a weekly program selected from those programmed.

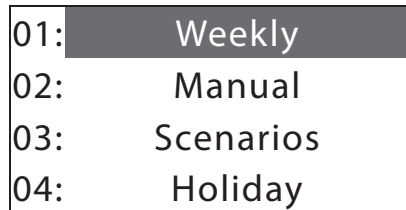

Select **Weekly**



OK

Press OK to confirm

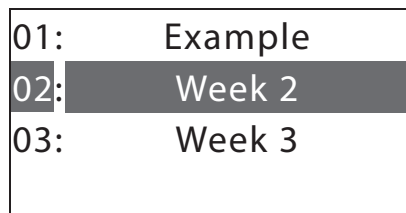

Select the weekly program (e.g.: Week 2)



OK

Press OK to confirm

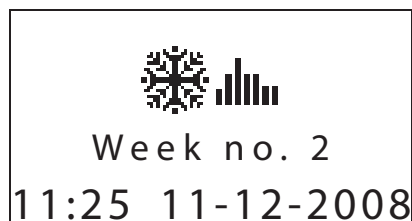

The initial page is displayed indicating the program set

6 - Main menu



6.1.2 - Manual

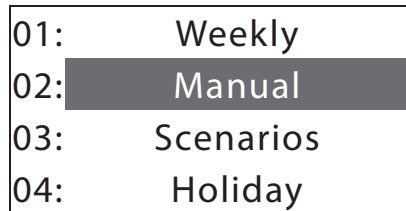

Can set a fixed temperature on the whole system or on the individual zone.



Select **Manual**



OK

Press **OK** to confirm

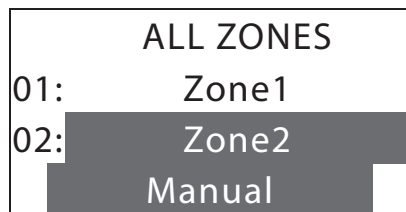

Select **ALL ZONES** or the zone required (e.g.: Zone 2)



OK

Press **OK** to confirm

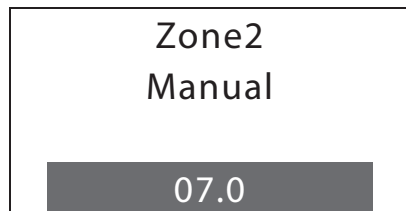

Type the temperature required using the number keys or using the keys to increase the temperature displayed by $\pm 0.5^{\circ}\text{C}$



OK

Press **OK** to confirm

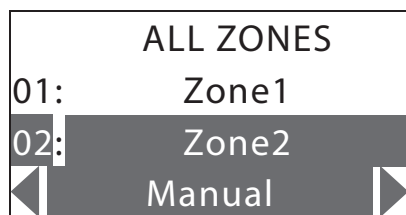

To place a zone set in Manual mode (number highlighted), in the normal mode of operation (general system mode) select it using the keys:



OK

Press **OK** to confirm



To return to the previous page, keep pressed to return to the first page

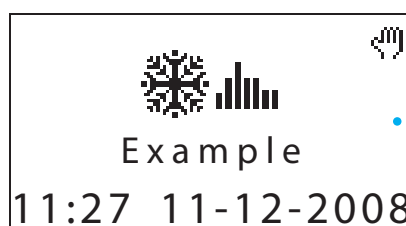

SOME ZONES

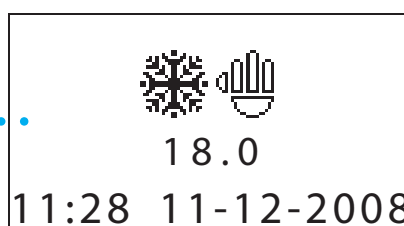

ALL THE ZONES

Depending on the selection made the first page is displayed

6 - Main menu



6.1.3 - Scenarios

Can activate a previously programmed scenario.

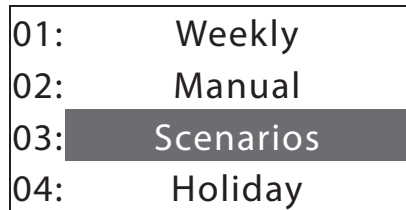

Select **Scenarios**



OK

Press **OK** to confirm

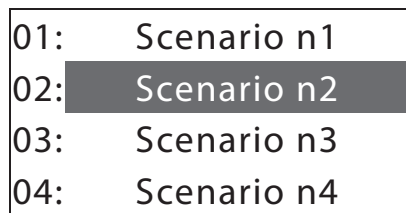

Select the weekly program (e.g.: Scenario n2)



OK

Press **OK** to confirm



Displays the first page indicating the scenario set

6 - Main menu



6.1.4 - Holiday

The Holiday mode can select a particular daily profile for a set period. The program is run until the programmed date and time, after which the weekly program chosen will be reset.

01:	Weekly
02:	Manual
03:	Scenarios
04:	Holiday



Select **Holiday**



OK

Press **OK** to confirm

up to
00:00
of
24/12/2008

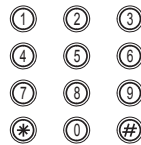

Type date and time using the number keys



OK

Press **OK** to confirm

01:	Example
02:	Week 2
03:	Week 3



Select the weekly program to be reset at the end of the Holiday (e.g.: Week 2)



OK

Press **OK** to confirm

12:30 24-12-08
11:31 11-12-2008

Displays the first page indicating the program set

6 - Main menu



6.1.5 - Holidays

This mode keeps the system in Antifreeze or Heat protection until the set date and time, after which the weekly program chosen will be reset.

- Antifreeze 7°C (for the heating function)
- Heat protection 35°C (for the air conditioning function).

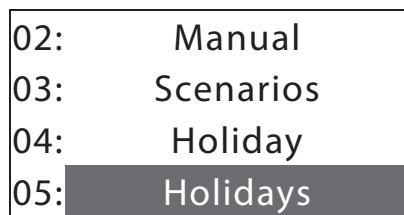

Select **Holidays**



OK

Press **OK** to confirm

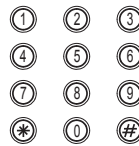
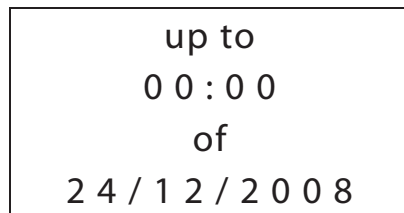

Type date and time using the number keys



OK

Press **OK** to confirm

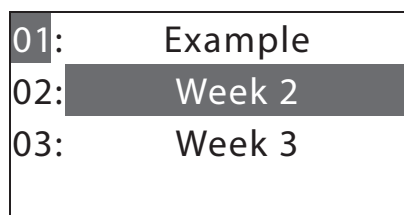

Select the weekly program to be reset at the end of the Holiday program (e.g.: Week 2)



OK

Press **OK** to confirm

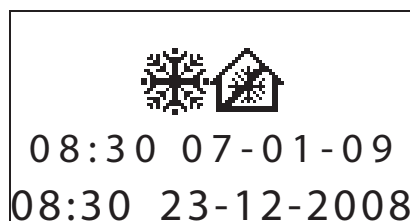

Displays the first page indicating the program set

6 - Main menu



6.1.6 - OFF

Can put all or some of the system zones in the OFF state, until one of the other modes is reset.

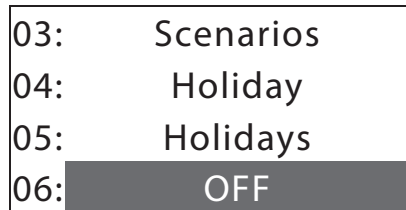

Select **OFF**



OK

Press **OK** to confirm

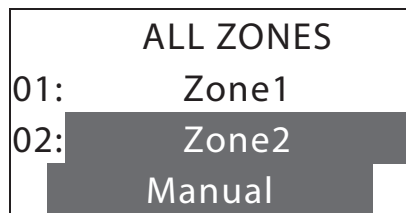

Select **ALL THE ZONES** or the Zone required (e.g.: Zone 2)



OK

Press **OK** to confirm

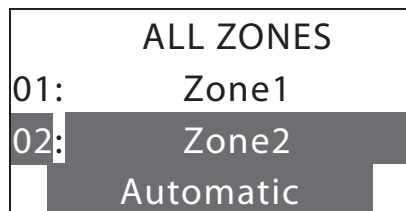

To put a zone set in OFF mode (number highlighted) in the normal mode of operation (general system mode), press **OK**



To return to the previous page, keep pressed to return to the first page



The initial page is displayed. The presence of the icon indicates that the mode is only active in some Zones

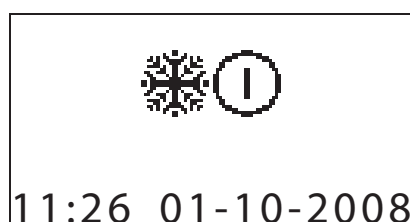

If the mode is active on ALL THE ZONES the first page displays "System off"

6 - Main menu



6.1.7 - Antifreeze / Heat protection

Can set the antifreeze or heat protection temperature in some or all of the system zones as a function of the type of operation active.



Select **Antifreeze/Heat protection**



OK

Press **OK** to confirm

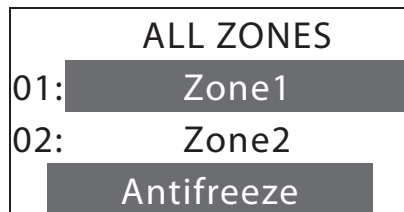

Select **ALL THE ZONES** or the Zone required (e.g.: Zone1)



OK

Press **OK** to confirm

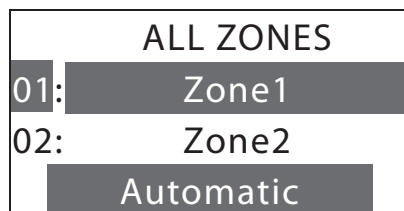

To put a zone set in Antifreeze mode (number highlighted) in the normal mode of operation (general system mode), press **OK**



To return to the previous page, keep pressed to return to the first page

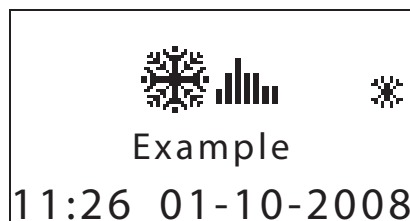

The initial page is displayed. The presence of the icon indicates that the mode is only active in some Zones

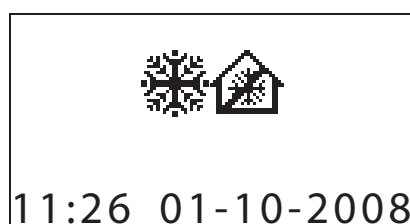

If the mode is active on ALL THE ZONES the first page displays "Antifreeze system"

6 - Main menu



6.2 - Zone state

Gives the temperature measured, the temperature set and the system state for each zone.

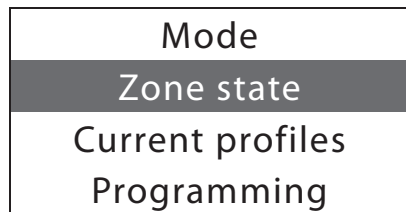

Select **Zone state**



Press **OK** to confirm

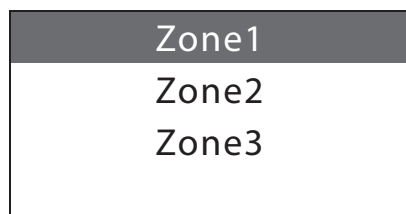

Select the Zone required (e.g.: Zone1)



Press **OK** to confirm

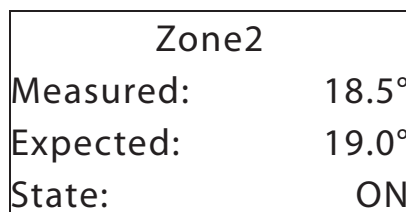
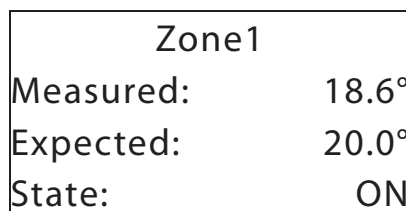
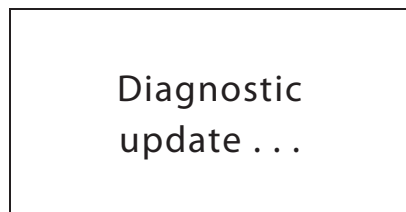

Use the keys to select the other zones (e.g.: Zone2)



Press  for 2 seconds to return to the first page

The display shows the following information:

- Temperature measured in the zone
- Temperature set in the zone
- System state in the zone:
 - ON = system ON
 - OFF = system OFF

If the system has a FAN-COIL the fan speed is given as well.

6 - Main menu



6.3 - Current profiles

Checks the mode of operation and the profile set for each zone.

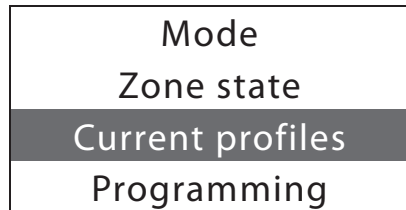

Select **Current profiles**



OK

Press OK to confirm

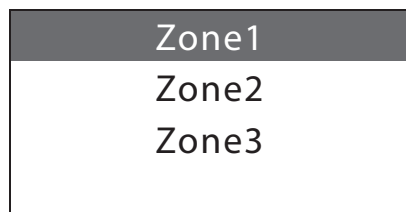

Select the Zone required (e.g.: Zone1)



OK

Press OK to confirm

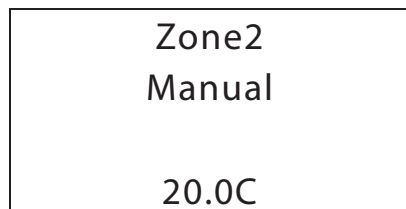
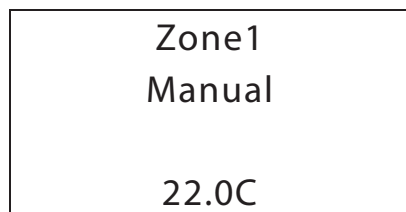

Use the keys to select the other zones (e.g.: Zone2)

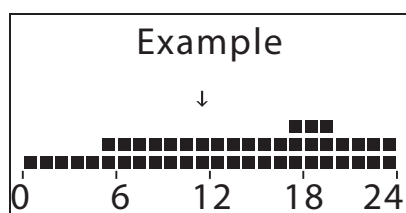

If the zone selected is in Weekly mode, the display of the heat profile set is displayed

Press  for 2 seconds to return to the first page

6 - Main menu



6.4 - Programming

This menu programs the profiles for the system modes of operation.

To access the **Programming** menu:

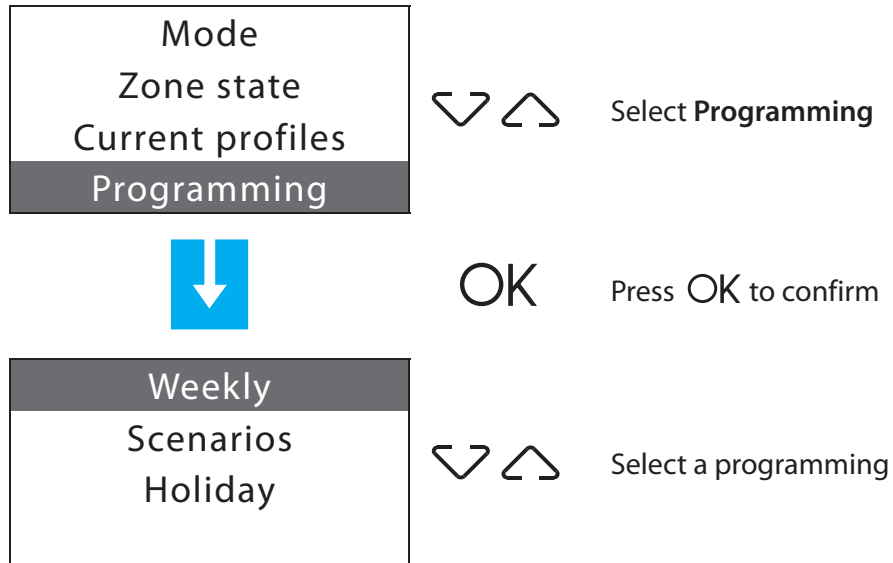

Programmings present:

- **Weekly** - 3 Winter programs, 2 Summer programs;
- **Scenarios** - 16 Winter scenarios and 16 Summer scenarios;
- **Holiday** - "Holiday" program for each zone.

6 - Main menu



6.4.1 - Weekly

Can create up to 3 weekly programs for each of the system modes of operation (heating and cooling). Different daily temperature profiles (0h – 24h) can be defined for each day and each zone.



Select **Weekly**



OK Press **OK** to confirm

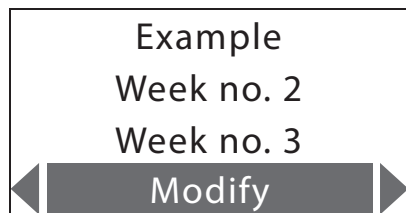

The following functions are available for the program selected.
Use the keys to select Line Test:

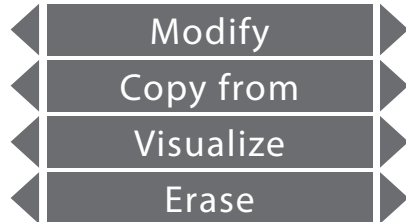

- Can modify the weekly program
- Can copy a weekly program
- Can visualize the daily profiles associated with each zone
- Can erase a weekly program

Note: the "Example" program is preset but can be modified

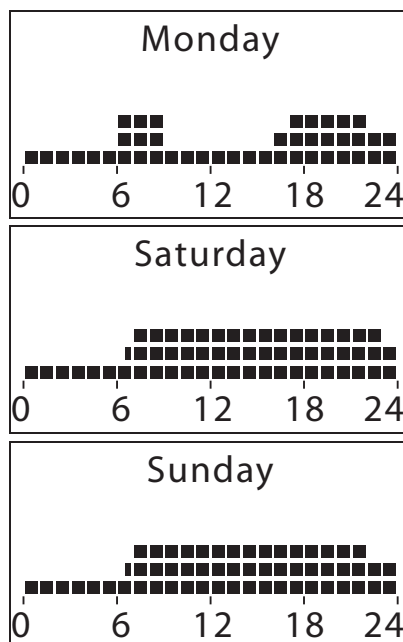

Monday – Friday

Saturday

Sunday

6 - Main menu



6.4.1.1 - Modify

This function can modify the weekly program selected, associating a daily profile to each zone.

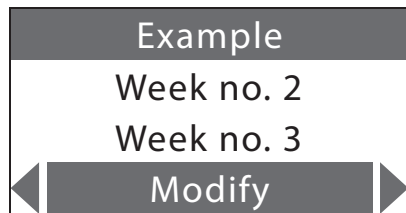

Select the program to be modified (e.g.: Example)



OK

Press OK to confirm



Select the day of the week (e.g.: Sunday)

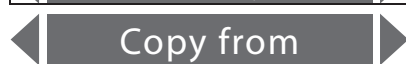

The "Copy from"(day) function is also available for the day selected



OK

Press OK to confirm

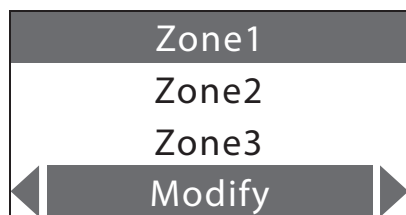

Select the zone (E.g.: Zone 1)

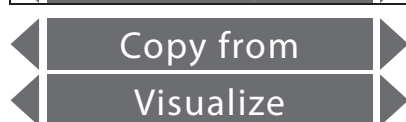

The "Copy from" (zone) and "Visualize" functions are also available for the zone selected



OK

Press OK to confirm

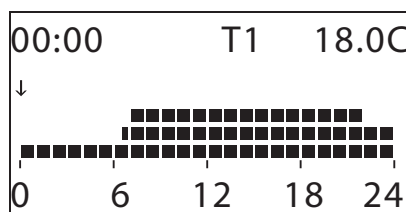

The profile displayed can be modified using the cursor keys and

For more information see the example on the next page.

6 - Main menu



Modifying a daily profile

The following information is shown on the display:

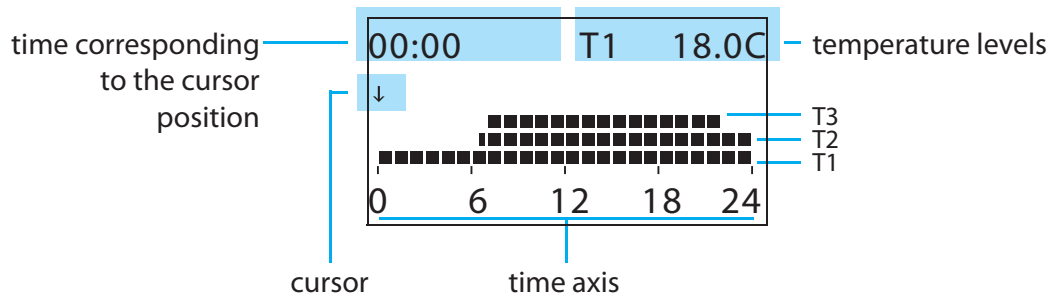

There are two modes of work:

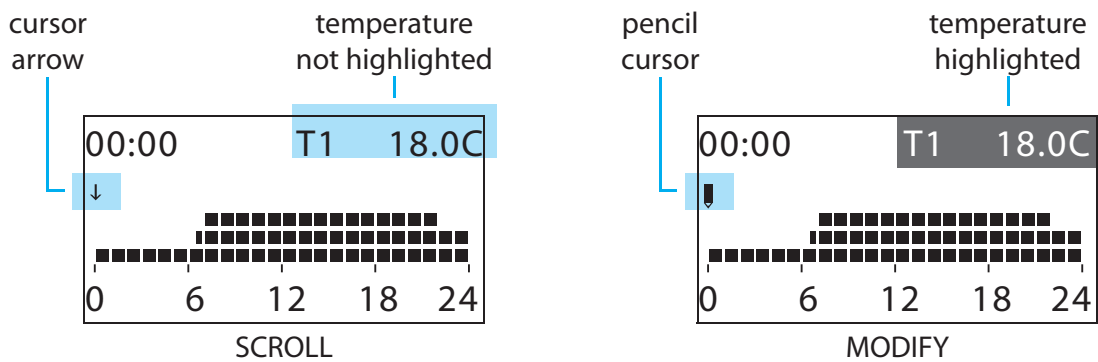

How to use the cursor keys:



OK

- Change from MODIFY mode to SCROLL.
- In SCROLL mode confirms quitting Modify



- Returns to the previous page without saving



- Change from SCROLL mode to MODIFY

- In the MODIFY mode scroll the three temperature levels



- Move the cursor along the time axis

6 - Main menu



Example:

writing the following daily temperature profile (Monday):

- from 00:00 06:00 - 18°C (T1)
- from 06:00 to 09:00 - 22°C (T3)
- from 09:00 to 16:30 - 20°C (T2)
- from 16:30 to 22:00 - 22°C (T3)
- from 22:00 to 24:00 - 20°C (T2)

TEMPERATURE LEVEL SET	
T1	18°C
T2	20°C
T3	22°C

Procedure:

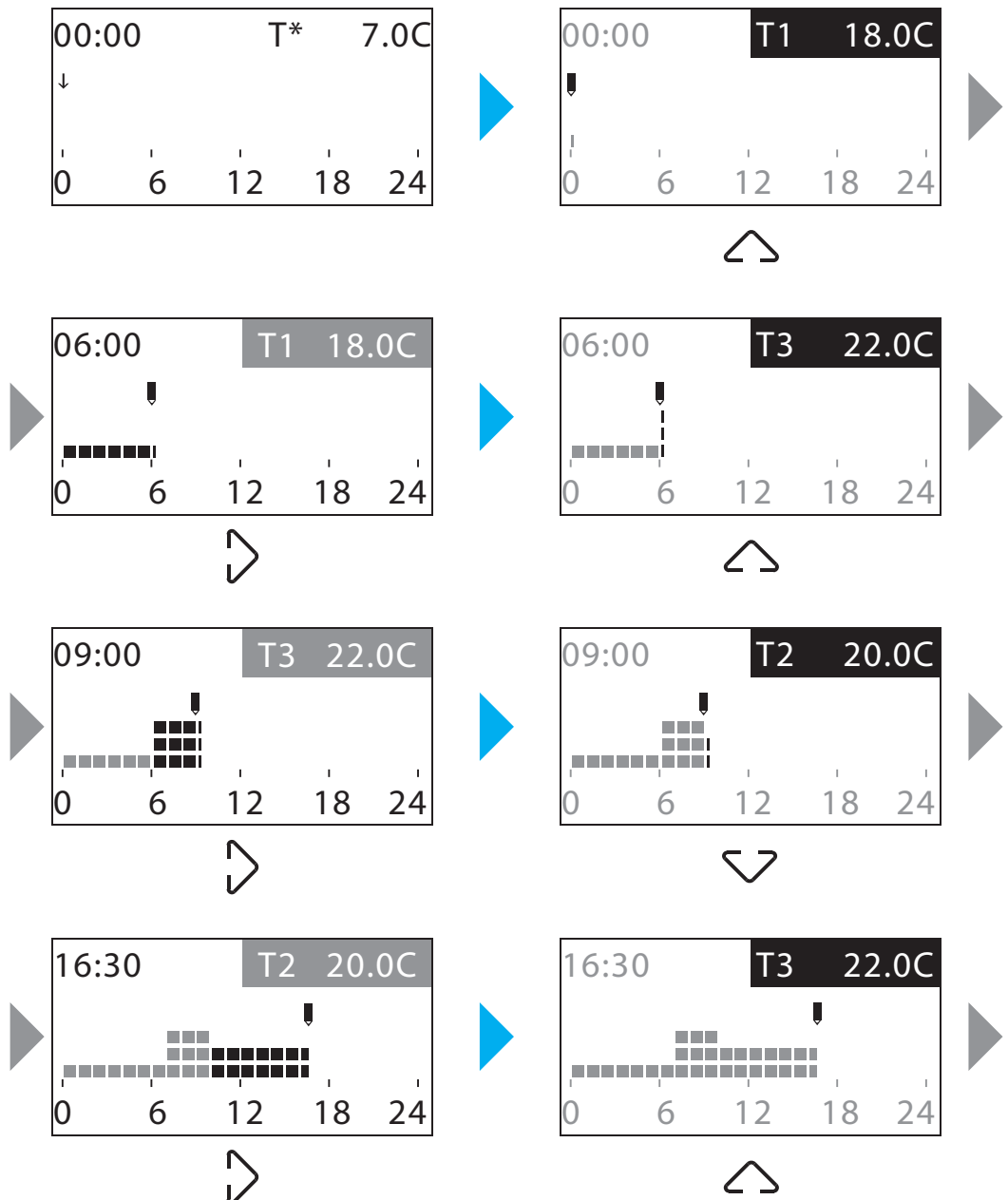

6 - Main menu

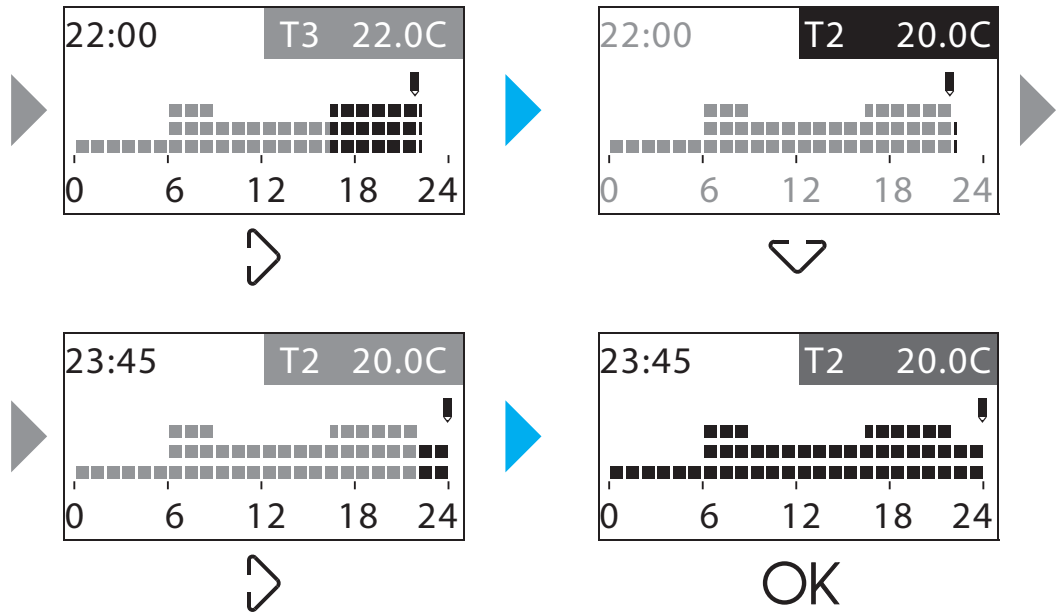

6 - Main menu



6.4.1.2 - Copy from (day)

Selecting the “Copy from” function a daily profile can be copied.

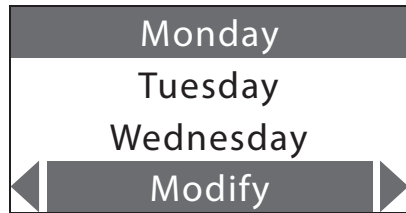

Select **Copy from**

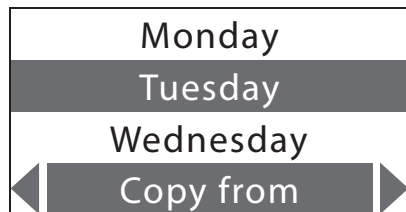

Select the day to be modified (e.g.: Tuesday)



OK

Press **OK** to confirm

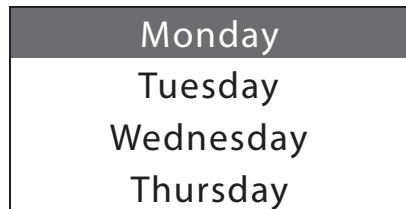

Select the day to copy (e.g.: Monday)



OK

Press **OK** to confirm

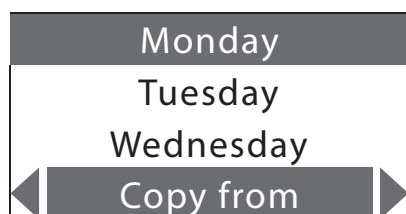
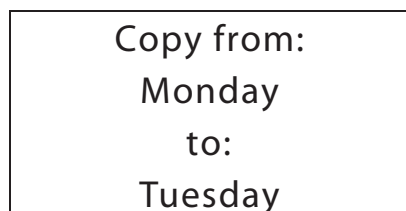

6 - Main menu



Copy from (zone)

Selecting the “Copy from” function the daily profile of a zone can be copied.

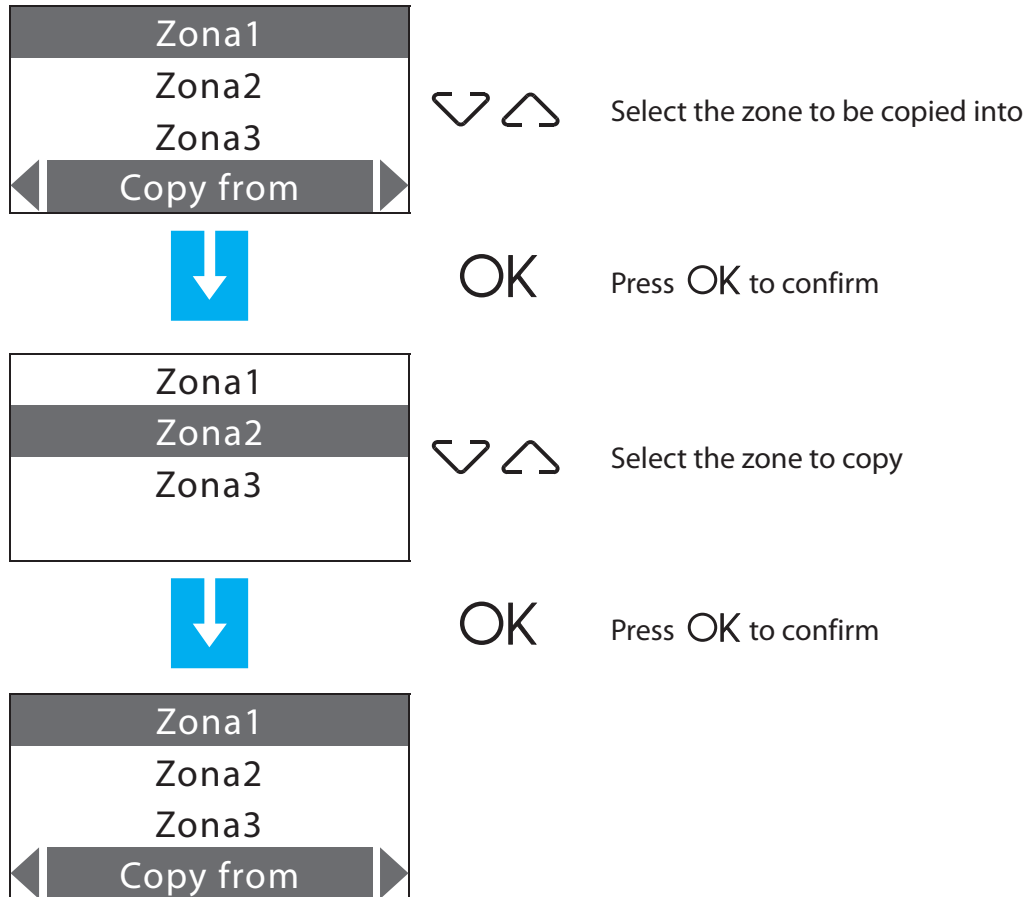

6 - Main menu



Copy from (weekly program)

This function can copy a weekly program.

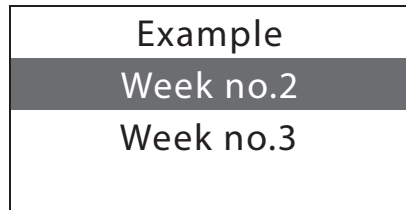

Select the zone to be copied into



OK

Press OK to confirm

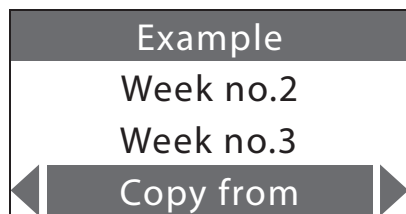



Select the day to copy

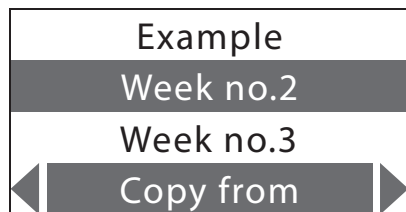
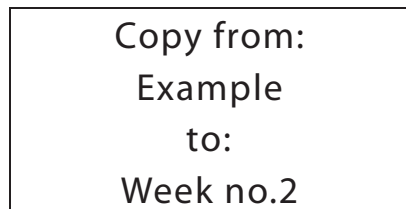

OK

Press OK to confirm



Press  for 2 seconds to return to the first page

6 - Main menu



6.4.1.3 - Visualize

This function can visualize the daily profiles associated with each zone.

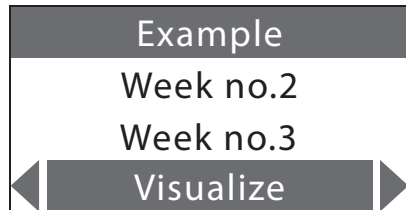

Select the weekly program (e.g.: Example)



OK

Press OK to confirm



Select the day of the week (e.g.: Sunday)



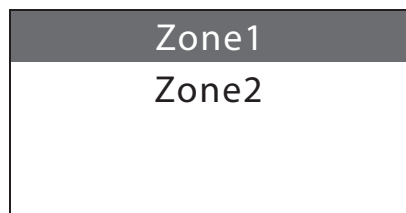

OK

Press OK to confirm

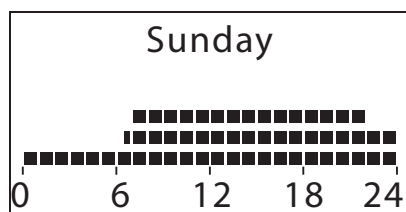

Select the zone (e.g.: Zone1)



Press  for 2 seconds to return to the first page

6 - Main menu



6.4.1.4 - Erase

This function can erase a weekly program resetting the default name, the profiles of all the zones and putting the program into antifreeze or heat protection.

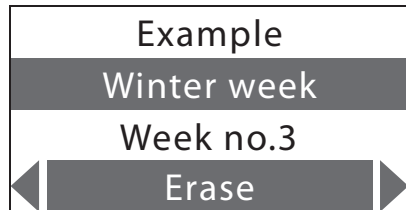

Select the program to be erased (e.g.: Winter week)



OK

Press OK to confirm





Select YES

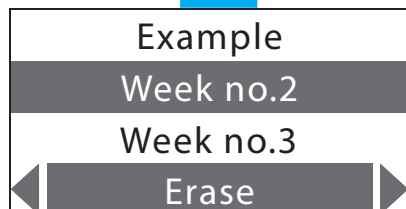
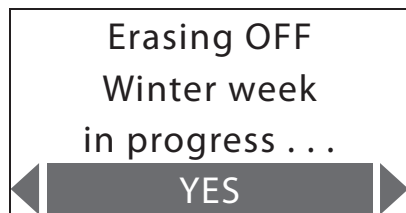

OK

Press OK to confirm



Press  to return to the previous page, keep pressed to return to the first page

6 - Main menu



6.4.2 - Scenarios

Can create 16 scenarios for the Winter working and 16 for the Summer working and for each of them set different temperatures in the various zones.

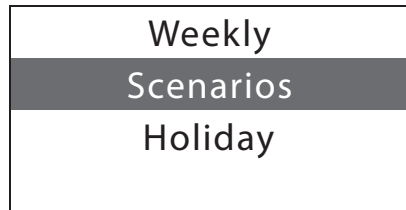

Select **Scenarios**



OK

Press OK to confirm

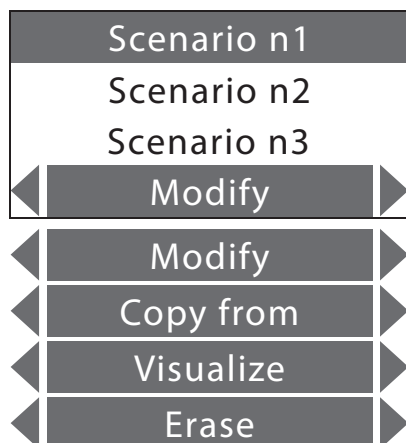

The following functions are available for the program selected:

- Modify: Can modify the scenarios
- Copy from: Can copy the scenarios
- Visualize: Can display the temperature levels set
- Erase: Can erase a scenario

Use the   keys to select the function required.

6 - Main menu



6.4.2.1 - Modify

This function can modify the selected scenario associating a temperature level to each zone.

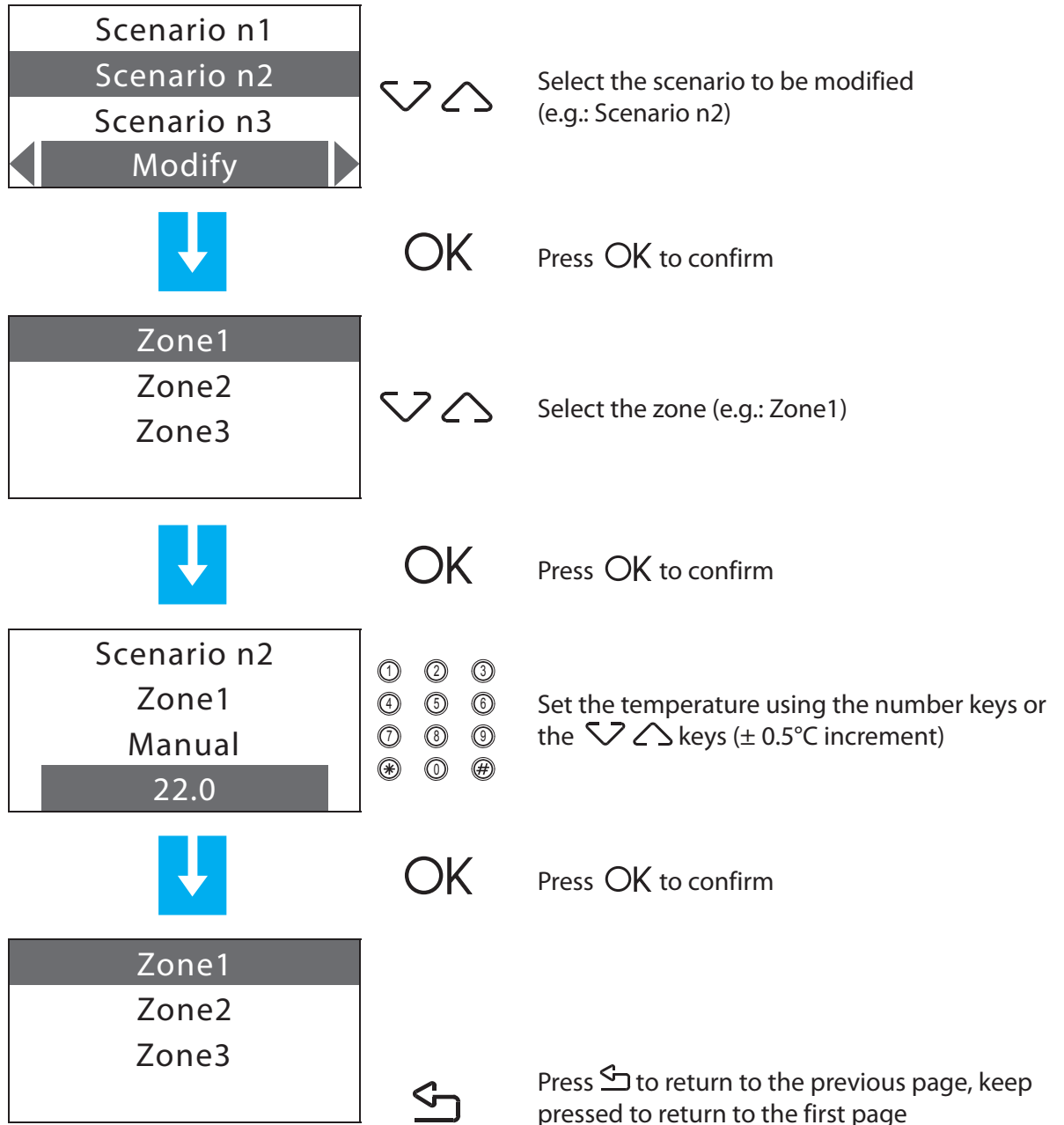

6 - Main menu



6.4.2.2 - Copy from

This function can copy a scenario (temperature level set for each zone).

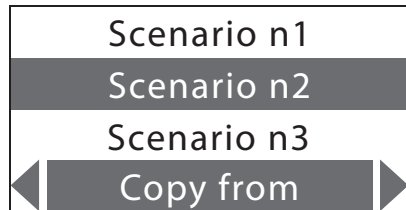

Select the scenario to be copied into
(e.g.: Scenario n2)



OK

Press OK to confirm

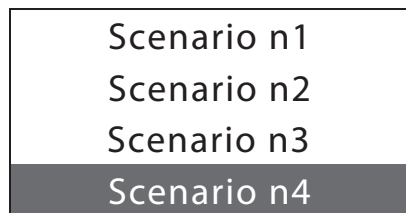



Select the scenario to copy
(e.g.: Scenario n4)

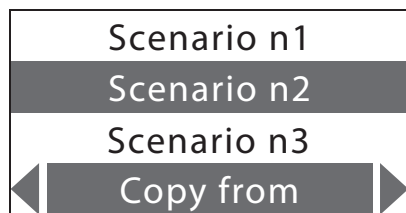

OK

Press OK to confirm



Press  to return to the previous page, keep pressed to return to the first page

6 - Main menu



6.4.2.3 - Visualize

This function can visualize the temperature level set for each zone.

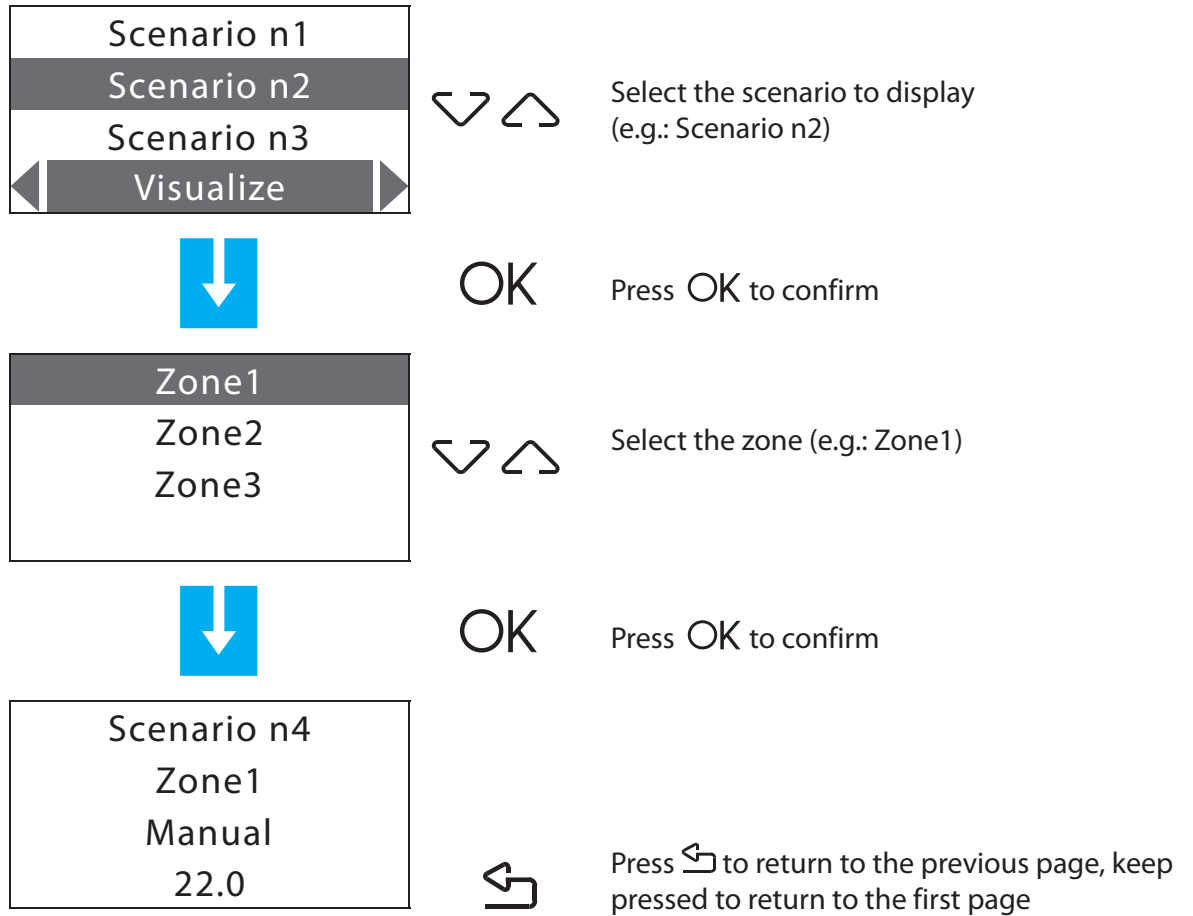

6 - Main menu



6.4.2.4 - Erase

This function can erase the selected scenario and reset the name and default temperatures (20°C for winter, 23°C for summer).

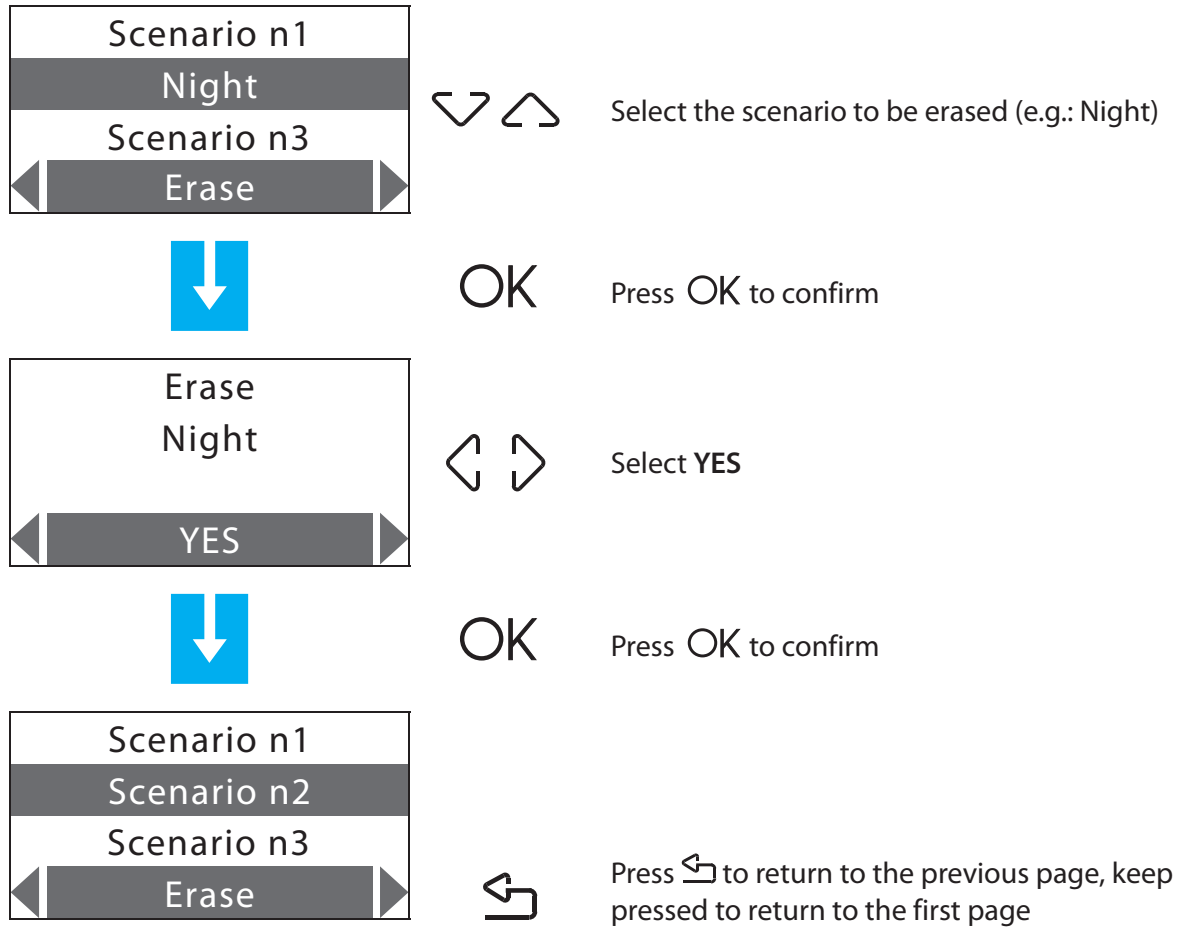

6 - Main menu



6.4.3 - Holiday

Can program a daily profile for each zone (as base the profile of the Sunday of the Example program is associated with each zone).



Select **Holiday**



OK

Press **OK** to confirm

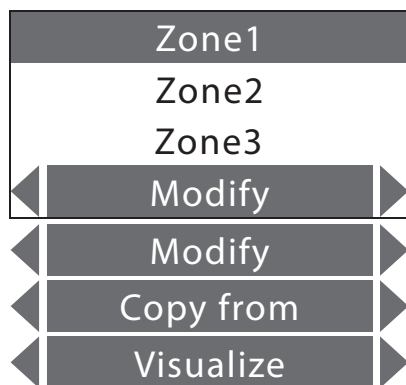

The following functions are available for the program selected:

Can modify the daily profile of the individual zones

Can copy the profile from another zone

Can visualize the daily profile associated with the zone

Use the   keys to select the function required.

6 - Main menu



6.4.3.1 - Modify

This function can modify the daily profile associated with a zone.

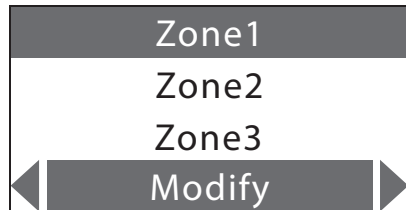

Select the zone to be modified (e.g.: Zone1)



OK

Press OK to confirm

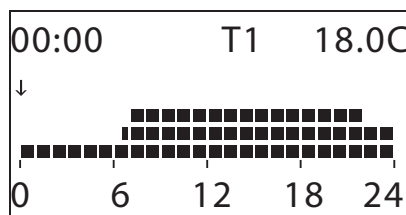

OK

Modify the daily profile

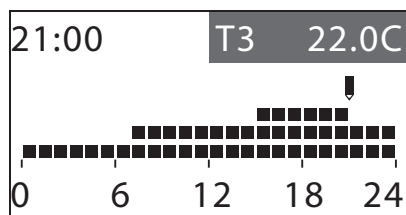

OK

Press OK to confirm

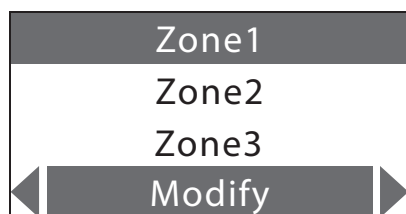

Press  to return to the previous page, keep pressed to return to the first page

6 - Main menu



6.4.3.2 - Copy from

Can copy the daily profile from an already programmed zone.

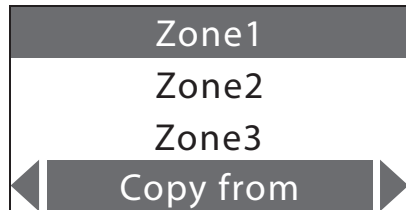

Select the zone to be copied into (e.g.: Zone1)



OK

Press OK to confirm

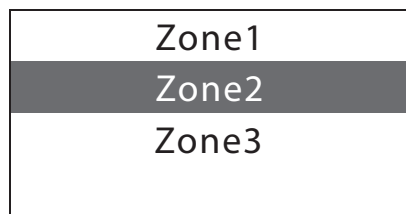



Select the zone to copy (e.g.: Zone2)

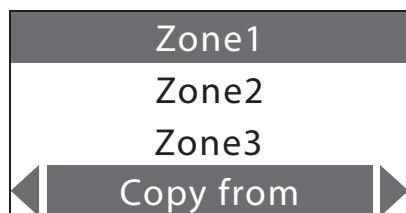

OK

Press OK to confirm



Press  to return to the previous page, keep pressed to return to the first page

6 - Main menu



6.4.3.3 - Visualize

This function can visualize the daily profile associated with each zone.

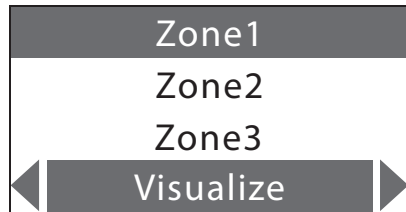



Select the zone to display into (e.g.: Zone1)

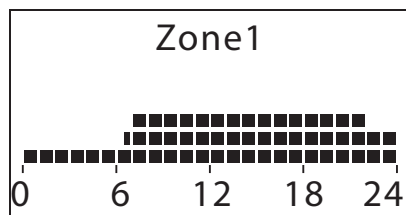

OK

Press OK to confirm



Press  to return to the previous page, keep pressed to return to the first page

6 - Main menu



6.5 - Setup

This menu can modify the available settings.

To access the **Setup** menu:

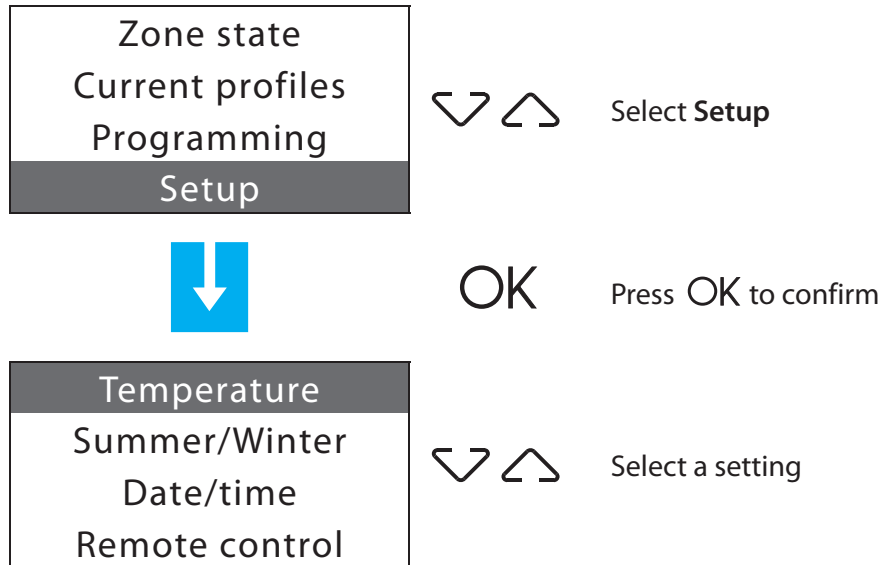

Settings present:

- **Temperatures** - temperature levels T1, T2, T3 and Antifreeze/Heat protection;
- **Summer / Winter** - system mode of operation;
- **Date / Time** - current date and time;
- **Remote control** - enable/disable remote control;
- **User code** - enable/disable and modify;
- **Contrast** - modify display contrast;
- **Diagnostics** - questioning and state of the system devices;
- **Probes** - query of the temperature probes and threshold adjustment;
- **Contacts management** - enables/disables the auxiliary contacts
- **Chiller** - query and status of the Climaveneta Chillers situated in the system.

6 - Main menu



6.5.1 - Temperatures

Can set the temperature levels T1, T2, T3 and Antifreeze/Heat protection (as base the same for all the zones) for each zone.

Temperature	
Summer/Winter	
Date/time	
Remote control	



Select Temperature



OK

Press OK to confirm

ALL ZONES	
Zone1	
Zone2	
Zone3	



Select ALL THE ZONES or the Zone required (e.g.: Zone 1)



OK

Press OK to confirm

T*	07.0C
T1	18.0C
T2	20.0C
T3	22.0C



Select the temperature level to modify (e.g.: T1)



OK

Press OK to confirm

T*	07.0C
T1	18.0C
T2	20.0C
T3	22.0C



Type the temperature required using the number keys or using the keys to alter the temperature displayed by $\pm 0.5^{\circ}\text{C}$

Press OK to confirm or to return to the previous page, keep pressed to return to the first page



The temperature values can be set from 3 to 40°C. To guarantee correct working of the system the control unit automatically makes sure that T3 is higher than T2 and T2 higher than T1.

6 - Main menu



6.5.2 - Summer/Winter

Sets the mode of operation of the Cooling or Heating system.

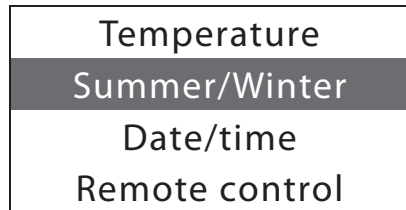

Select **Summer/Winter**



OK

Press **OK** to confirm



The display indicates the current state: Winter



OK

Press **OK** to confirm



*A **BEEP** signals that the modification has been made the display indicates the new setting: **Summer***



After the switching the system is set on Antifreeze/Heat Protection mode.

Before performing the switching, perform all the operations necessary for correct working on the hydraulic system.

6 - Main menu



6.5.3 - Date/time

Sets the current date and time.

Setting the **Date/time** correctly is important in running the weekly programs set correctly.

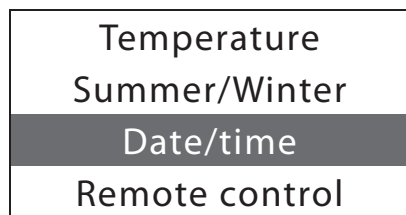

Select **Date/time**



OK

Confirm by pressing OK

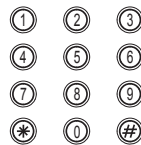
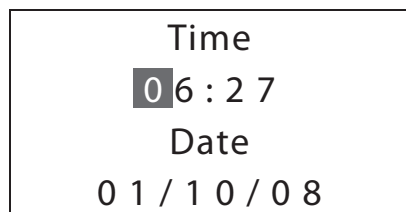

Type current Time and Date

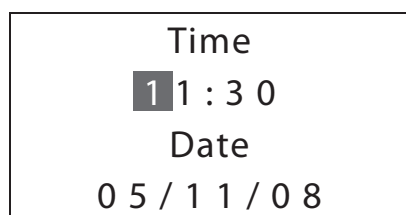

The keys move the selection by one digit



The keys change the Time/Date line and vice versa



OK

Confirm by pressing OK

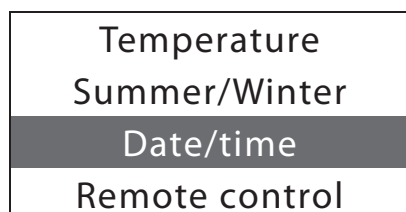

Press to return to the previous page, keep pressed to return to the first page

6 - Main menu



6.5.4 - Remote control

Can enable/disable the remote control for remote management (user) and remote after-sales service (installer) using portal. The remote management lets the user know and control the temperature of each zone remotely. The remote after-sales service lets the installer program the control unit and perform the system diagnostics remotely.

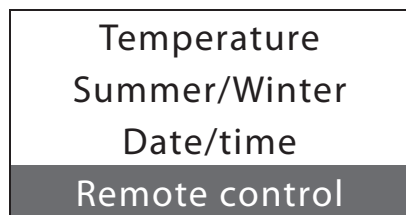

Select **Remote control**



OK

Confirm by pressing OK



*The display indicates the current state: **enabled***



OK

Confirm by pressing OK



*The display indicates the new setting: **disabled***



As factory setting the remote control is enabled.

To use the Colour Touch Screen (5739 60) enable the remote control. If the remote control is disabled the control unit does not manage the "Remote" contact and does not perform any command received from the bus.

6 - Main menu



6.5.5 - User code

Can enable/disable and customise the user code (as base 00000).



Select **User code**



OK

Confirm by pressing OK



The display indicates the current state: **disabled**



OK

Press OK to confirm and change the state

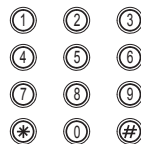
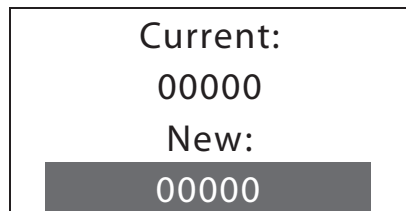

Type the **New** code (five digits) or confirm the **Current** code



OK

Press OK to save

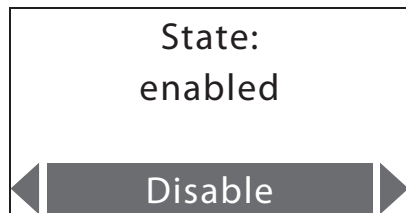

The display indicates the new setting: **disabled**

From now on you must type the user code set to access the Main menu



The following functions are available:

Can disable the User Code

Can modify the User Code

Use the keys to select the function required



If a new user code is set, make a note of it in the space on page 40 of the User Manual.

6 - Main menu



6.5.6 - Contrast

Sets the level of contrast of the graphic display.

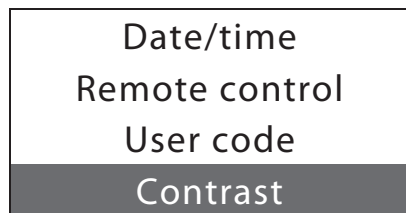

Select **Contrast**



OK

Confirm by pressing OK

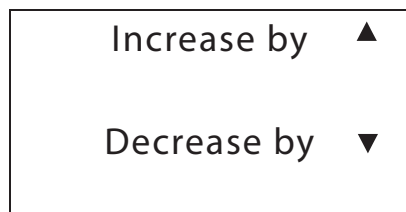



Set the contrast level required

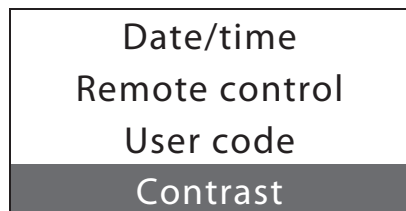

OK

Press OK to confirm



Press  to return to the previous page, keep pressed to return to the first page

6 - Main menu



6.5.7 - Diagnostic

If there is a fault in one or more of the system zones it can check the devices installed in the individual zones.

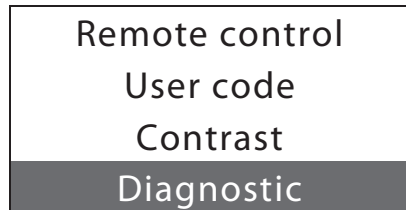

Select **Diagnostic**



OK

Press **OK** to confirm

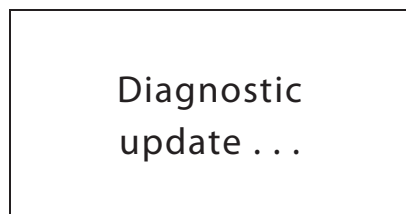

The control unit automatically updates the system diagnostic state

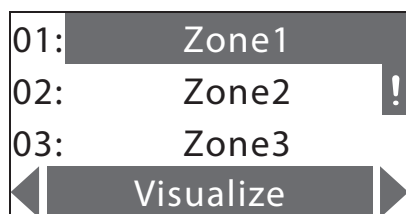

Select the **zone**

The following functions are available for the zone selected:

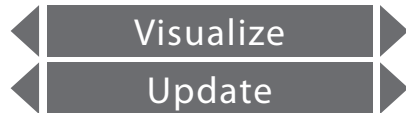

Can visualize the state of the zone selected

Can question the probe of the zone selected

Use the keys to select the function required.

If Climaveneta Chillers are detected during the diagnostic phase, "CHILLER DIAGN." will appear, thus making it possible to verify their status.



The "!" symbol identifies the zone where there are running problems.

6 - Main menu



6.5.7.1 - Visualize

Visualizes the diagnostic information of the zone required in detail.

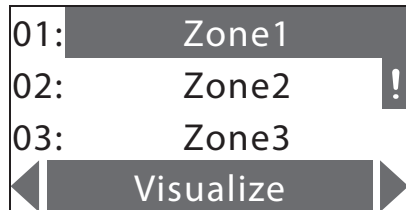

Select the zone (e.g.: Zone1)



OK

Press OK to confirm

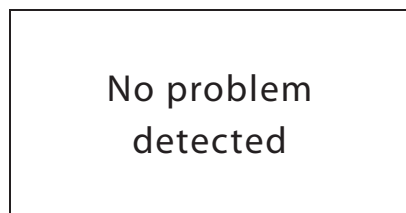

The display indicates the zone state



Press  to return to the previous page

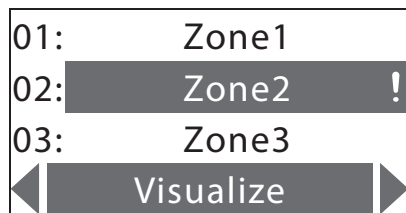

Select the zone (e.g.: Zone2)



OK

Press OK to confirm

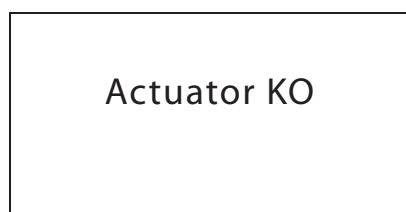

The display indicates the zone state



Press  to return to the previous page, keep pressed to return to the first page



To deal with any faults, consult the "Troubleshooting" section in this manual.

6 - Main menu



6.5.7.2 - Update

Can question the probe to update the state of the zone selected.

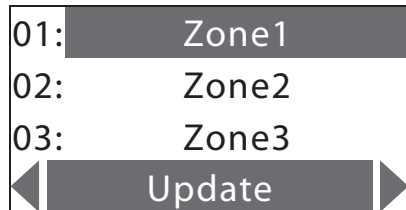



Select the zone (e.g.: Zone1)

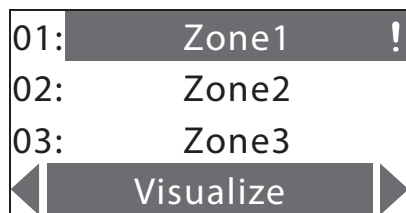
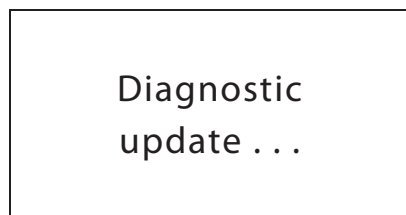

OK

Press OK to confirm



Press  to return to the previous page, keep pressed to return to the first page

6 - Main menu



6.6 - Probes

Displays the list of the probes configured through the ThermoConfig software and changes its set threshold value.

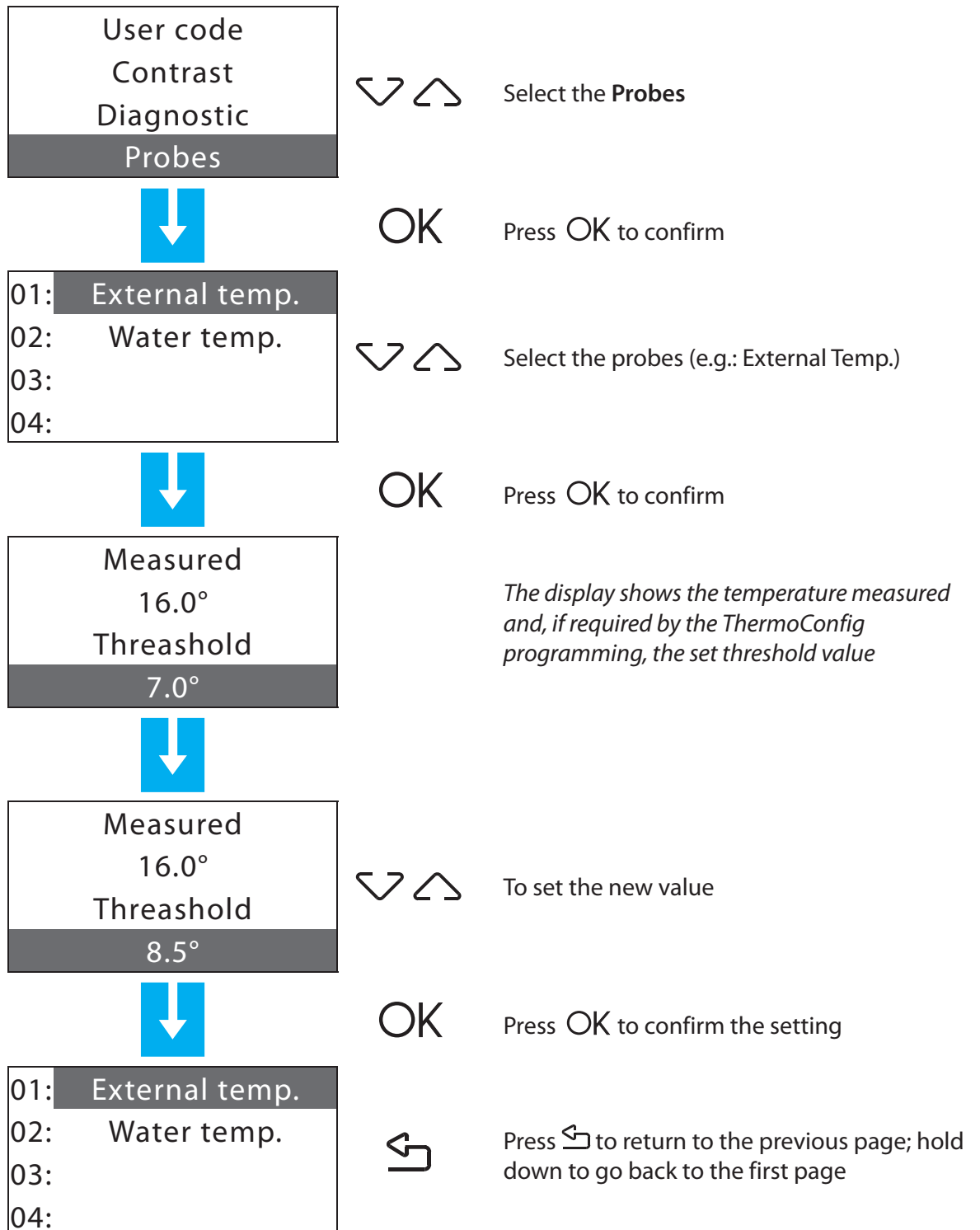

6 - Main menu



6.7 - Contacts management

Enables/disables the management of the auxiliary contacts (e.g. window contacts).



Select the **Contacts manag.**



OK

Press OK to confirm



OK

Press OK to change the current setup

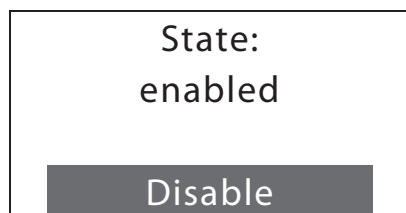

Press  to return to the previous page; hold down to go back to the first page



6 - Main menu



6.8 - Chiller

This menu appears entirely if one or more Climaveneta Chillers have been detected in the system. Allows you to change the settings of the Chillers in the system.

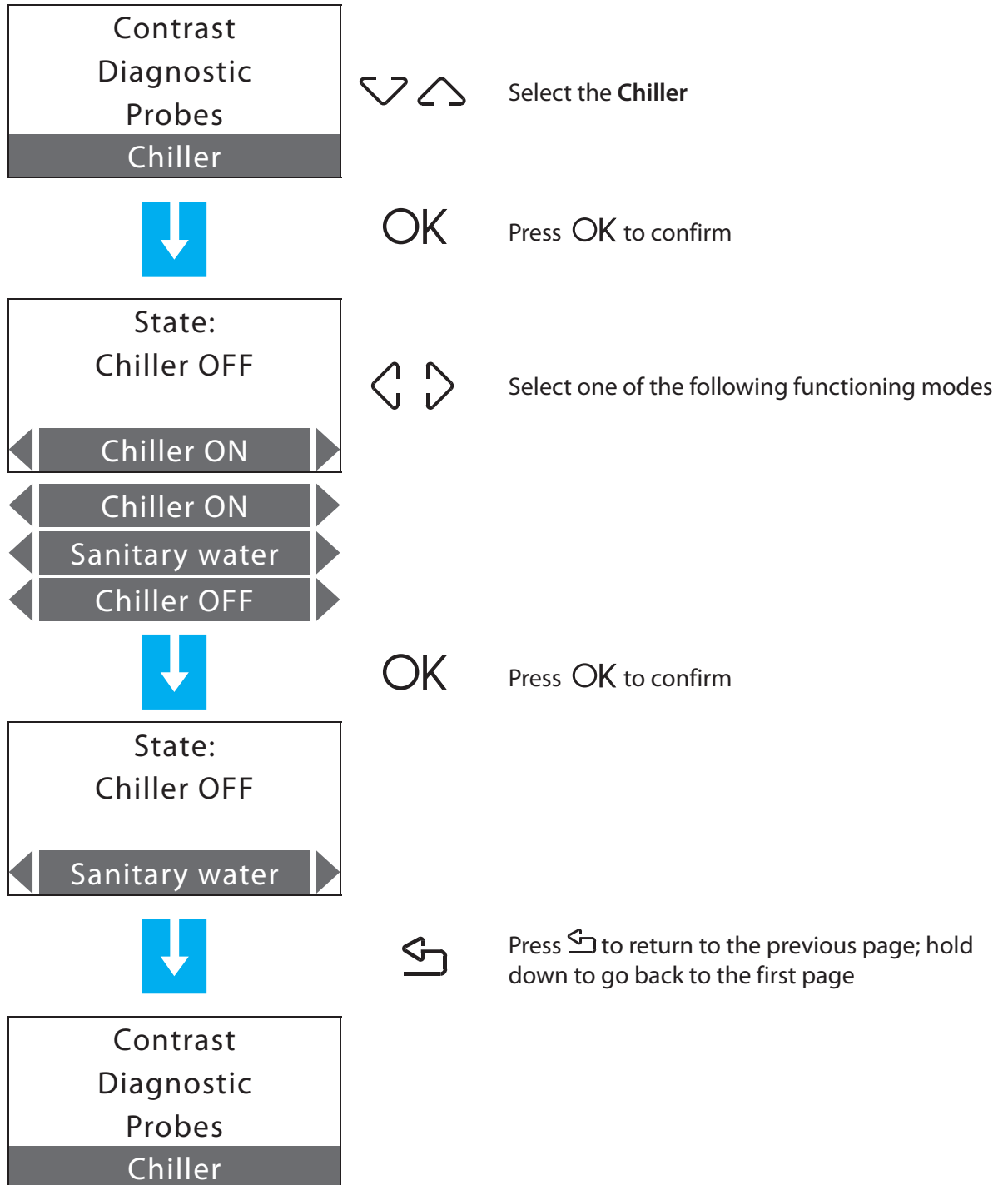

6 - Main menu



6.9 - Maintenance

To prevent inexperienced users from modifying the settings and affecting the operation of the Temperature control unit, access to this menu is protected by the **Maintenance Code** (base 12345).

To access the MAINTENANCE menu:

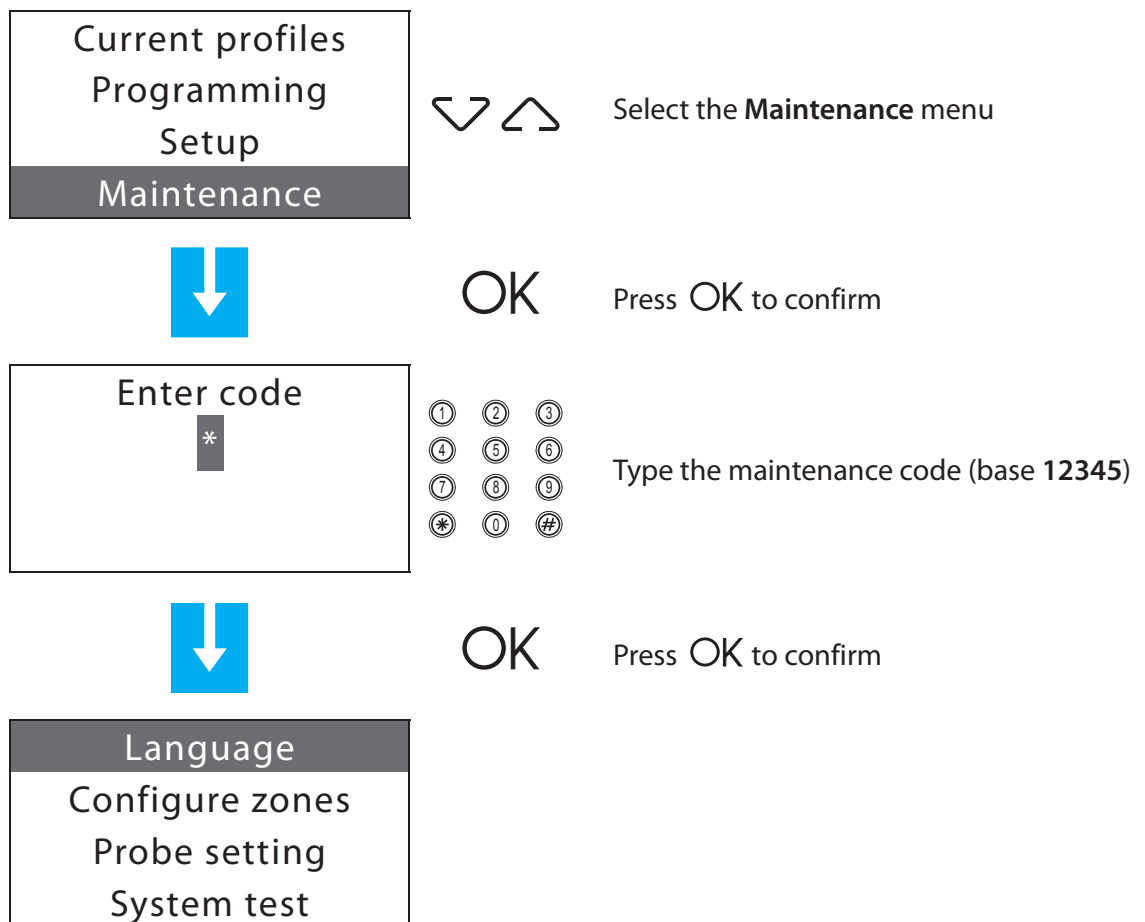

Items present:

- **Language** - Can select the language (base Italian);
- **Configure zones** - Can configure the system zones;
- **Probe setting** - Can vary the temperature measured;
- **System test** - Can perform maintenance or checks on the system;
- **Maintenance code** - Can customise the maintenance code;
- **Total reset** - Resets the control unit totally.

6 - Main menu



6.9.1 - Language

Can select the language in which the messages are shown on the display.

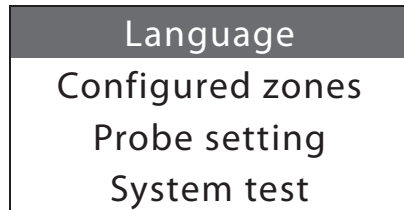

Select Language



OK

Confirm by pressing OK



Select the language required
Enter by pressing OK

6 - Main menu



6.9.2 - Configure zone

Can perform the system learning and manage the zone configuration.

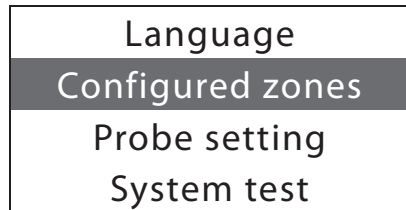

  Select **Configure zones**



OK Confirm by pressing OK

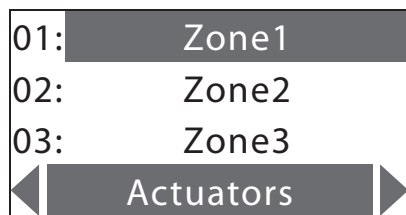

  Select the zone

The following functions are available for the zone selected:

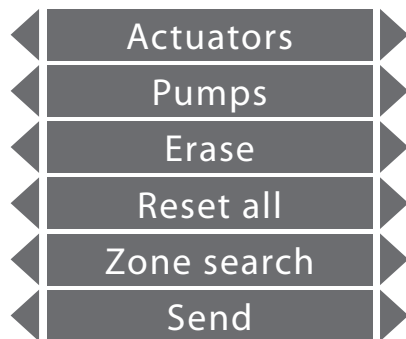

Can configure the actuators for the zone selected

Can configure the pumps for the zone selected

Can erase the zone selected

Can zero the configuration of all the zones

Searches all the zones in the system

Configures the zones on the basis of the settings received from the PC via the ThermoConfig software

Use the   keys to select the function required.

6 - Main menu



6.9.2.1 - Actuators

This function completes the zone configuration, indicating:

- which actuators are installed for Heating;
- which actuators are installed for Cooling;
- which type of load the zone manages.



Only perform with Standard configuration (see Technical Guide)

01:	Living room
02:	Zone2
03:	Zone3
Actuators	



Select the **zone** (e.g. Living room)



OK

Confirm by pressing OK

01:	Heating
02:	Heating
03:	Cooling
Not connected	



One of the following options can be selected for each actuator in the list:

Not connected	
Heating	
Cooling	
Heat. & cool.	

Not present on the system

Is used to manage the Heating system

Is used to manage the Cooling system

Is used to manage both the Heating system and the Cooling system (e.g.: 2-pipe fan coil)



OK

Confirm by pressing OK

09:	Not connected
H:	ON/OFF
C:	OPEN/CLOSE
FAN-COIL 3V	



The last two items of the menu can select the type of load managed



NEXT

6 - Main menu



09: Not connected
 H: ON/OFF
 C: OPEN/CLOSE
 FAN-COIL 3V



One of the following options can be selected for each actuator in the list:

FAN-COIL 3V
 GATEWAY
 ON/OFF
 OPEN/CLOSE

Fan-coil with control of one valve and selector switch up to 3 speeds

Interface for Climaveneta Fan-coil

Load managed by just one contact (e.g.: thermostatic valve)

Load managed by two interlocked relays (e.g. motor-driven valve with opening contact and closing contact)



Press the  key to send the configuration set to the zone

Zone test ...

The control unit tests the configuration. When this is finished there may be two error messages:



01: Living room
 02: Zone2
 03: Zone3
 Pumps

Configuration
invalid

Trying to set a configuration of actuators which is not allowed (example: actuators of different type for the same function) in a probe

ERROR
Verify the
probe
configuration

Check that the probe is in standard configuration (MOD=CEN) and try again; if it is not this type of configuration, the control unit cannot configure the probe.

6 - Main menu



6.9.2.2 - Pumps

Can complete the zone configuration, indicating which pumps must control the zone and with how much delay.



This function can only be used if the probe is configured with the CEN configurator in socket P.

01:	Living room
02:	Zone2
03:	Zone3
Pumps	



Select the **Zone** (e.g.: Living room)



OK

Confirm by pressing OK

01:	Heating
02:	Heating
03:	Cooling
Not connected	



One of the following options can be selected for each actuator in the list:

Not connected	
Heating	
Cooling	
Heat. & cool.	

Not present on the system or not managed by the zone selected

Is used to manage the Heating system

Is used to manage the Cooling system

Is used to manage both the Heating system and the Cooling system



OK

Confirm by pressing OK

09:	Not connected
H:	1
C:	0
0	



The last two items of the menu can select the delay in activating the pump



Selects the minutes of delay



OK

Press OK to confirm

NEXT

6 - Main menu



Zone test . . .



01:	Living room
02:	Zone2
03:	Zone3
◀ Pumps ▶	



Press the  key to send the configuration set to the zone.

The control unit tests the configuration:

The following error message may be given

ERROR
Verify the
probe
configuration

Check that the probe is in configuration (P=CEN) and try again; if it is not this type of configuration, the control unit cannot configure the probe.

6 - Main menu

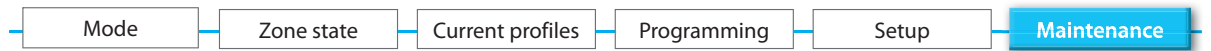

6.9.2.3 - Erase

Can erase the zone selected from the configuration.

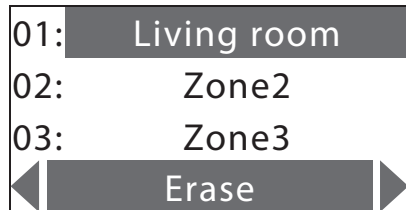

Select the **zone**



OK

Press **OK** to confirm

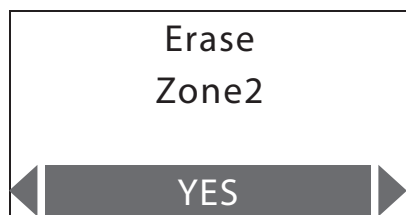



Select **YES**

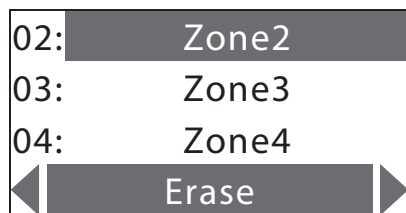

OK

Press **OK** to confirm



Press  to return to the previous page; hold down to go back to the first page



The Control Unit no longer manages the erased zones.

6 - Main menu



6.9.2.4 - Reset all

Can erase the saved configuration of all the zones.

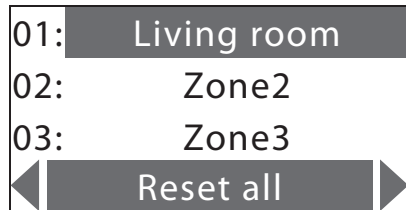

OK Press OK to confirm

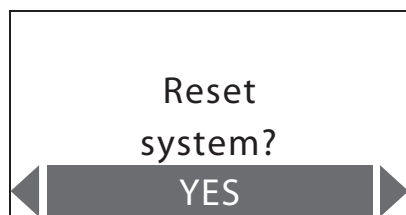

◀ ▶ Select YES



OK Press OK to confirm

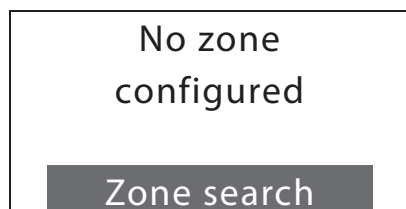
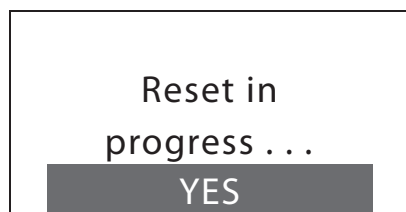

*From this moment on the Control Unit no longer manages any zones.
To reset the system operation, perform the zone LEARNING*

6 - Main menu



6.9.2.5 - Zone search

Searches all the zones in the system.



OK

Press OK to confirm

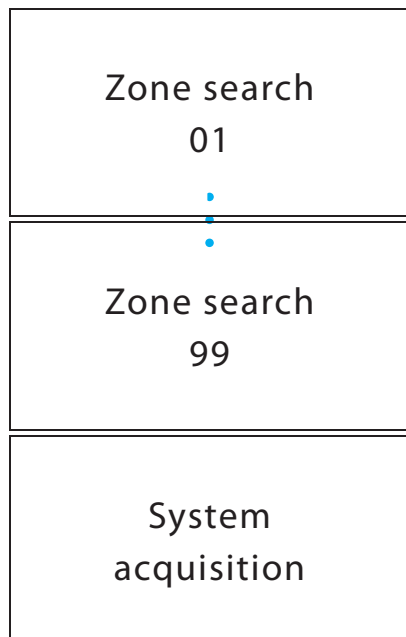

The system searches the zones from 1 to 99. Depending on the system size, this operation may take a few minutes



When the search has finished it returns to the Configure zones menu

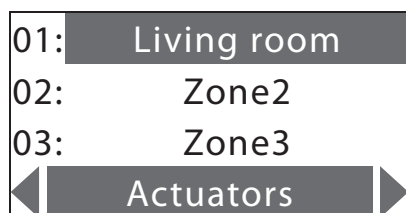

Press  to return to the previous page; keep pressed to return to the first page

6 - Main menu



6.9.2.6 - Send

Sends the actuator and pump settings to all the configured zones.

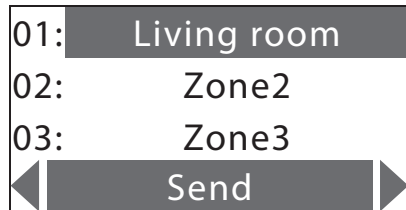

OK

Press OK to confirm

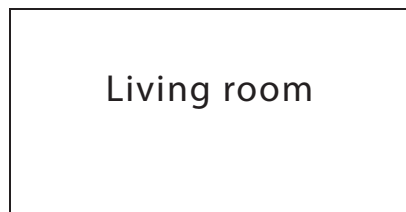

The control unit sends the configuration set to the zones in the system.



This message may be displayed during the send phase:

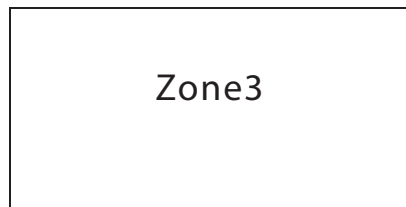
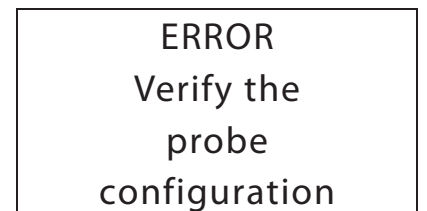

Pressing  cancels sending the configuration
Press OK to go to the next zone

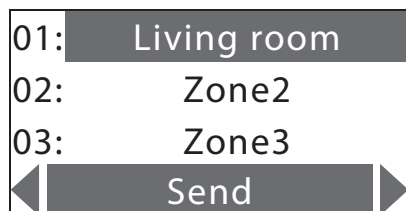

When the send is completed, it returns to the Configure zones menu

6 - Main menu



6.9.3 - Probe setting

Can align the temperature measured by the probes to a value measured with other devices (thermometer,...) to guarantee better precision in system operation.

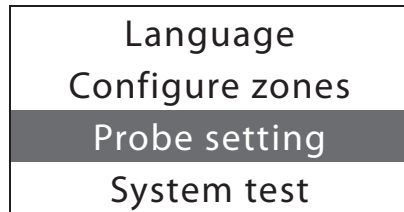

Select **Probe setting**



OK

Confirm by pressing OK

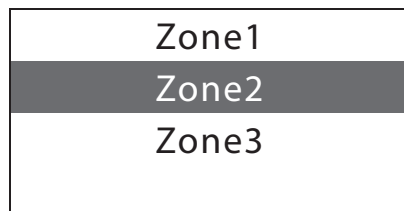

Select the zone (e.g.: Zone2)



OK

Press OK to confirm

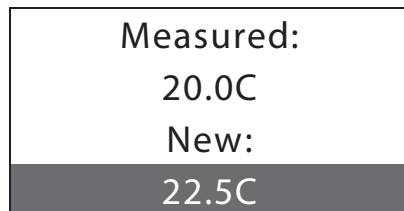



Set the effective temperature measured in the room ($\pm 0.1^{\circ}\text{C}$ increment)

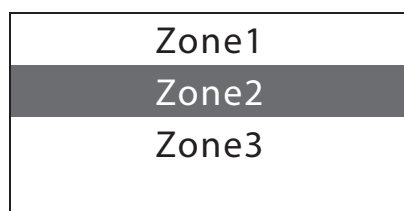
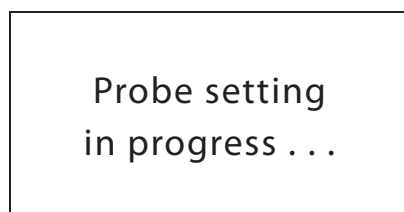

OK

Press OK to confirm



Press  to return to the previous page; keep pressed to return to the first page

6 - Main menu



6.9.4 - System test

Can put the **System in test** (the whole system OFF) to check the system. It automatically disables all the commands (including the remote commands).

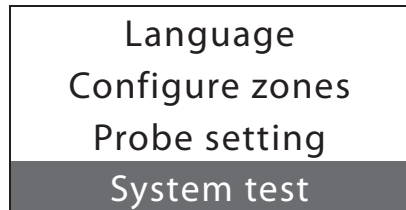

Select **System test**



OK

Confirm by pressing OK

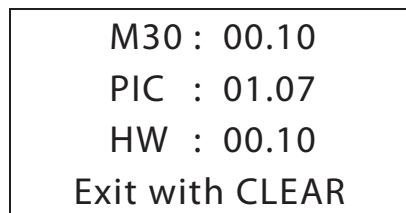

The display indicates the Control Unit software and hardware versions:

M30 – firmware version

PIC – firmware version SCS interface

HW – hardware version



Press  to return to the previous page

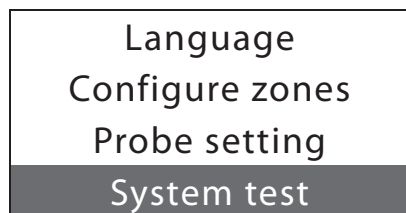

6 - Main menu



6.9.5 - Maintenance code

Can set a new Maintenance code.

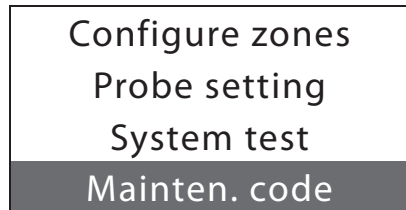

Select the Maintenance Code



OK

Press OK to confirm

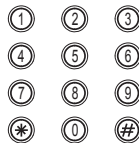

Type the new maintenance code (e.g.: 55555)



OK

Press OK to confirm

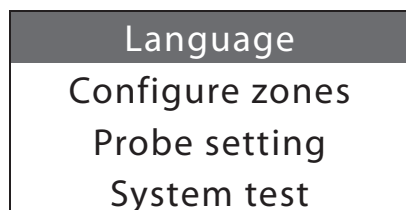

From now on you must type the new code set to access the Maintenance menu



If a new MAINTENANCE CODE is set, make a note of it in the space on page 22 of this manual.

6 - Main menu



6.9.6 - Total reset

Can perform a Control Unit total reset. All the settings will be lost and the factory settings will be reset (see page 10 of the manual).

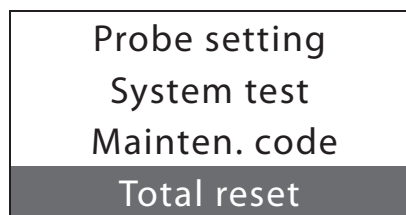

  Select **Total reset**



OK Press OK to confirm

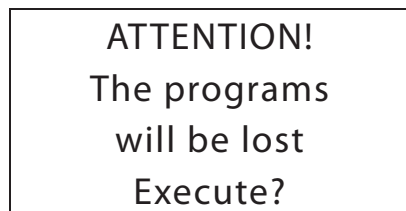

OK Press OK to confirm



The Reset operation takes about 30 seconds.

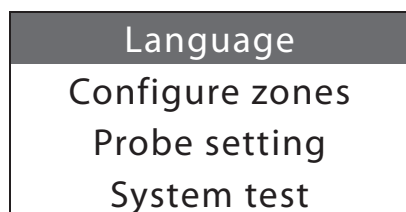

Press  to return to the previous page, keep pressed to return to the first page



With this operation the system configuration and all the programs run will be lost!

6 - Main menu



6.9.7 - Automations

By using the ThermoConfig software, it is possible to programme automations that will start operating when specific temperature conditions, detected by the gateway or probes in the system, occur. In this menu it is possible to enable or to disable the programmed automations.

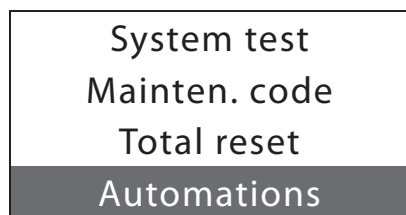

 Select **Automations**



OK Press OK to confirm

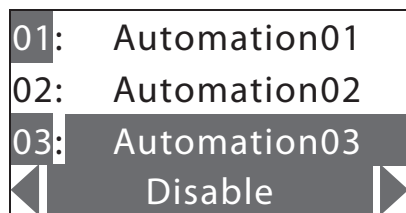



 Select the automation (the active automations are identified by the highlighted number)

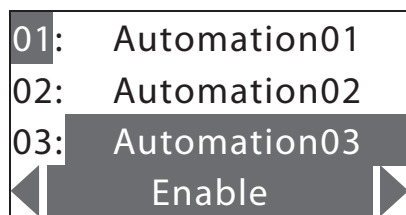

OK Press OK to to disable the Automation



 Press  to return to the previous page, keep pressed to return to the first page

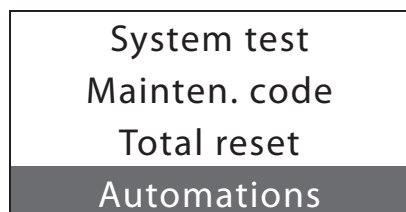

Appendix

Technical data

Power supply	from SCS bus: 18 – 28 V
Absorption	Stand-by: 55 – 90 mA Max
Operating temperature	5 – 40 °C
Telephone line	DTMF/PULSES
Dimension	L= 125 mm; H= 128 mm; P= 31 mm
Degree of protection	IP 30

Standard references

The Item in this manual is provided with the CE Conformity Declaration according to the requirements shown below:

Legrand declares that the product, Item:

5739 18/19

is in compliance with the essential requirements of the 2006/5/CE directive, as it complies with the following standards:

EN60950 EN50090-2-2

CE mark year, according to the specified directive: 2008

More information concerning reference standards can be found at:

www.legrandelectric.com

Troubleshooting

PROBLEM	SOLUTION
Battery flat signal	Check that the battery is correctly connected. If the problem continues, replace the battery.
A zone does not adjust correctly	Check whether any problems have been signalled (Settings>Diagnostic>Update).
A zone signals "Error on probe"	The probe does not respond; check whether it is correctly connected (green LED shining steadily or flashing slowly) and configured (correct zone number and mode).
A zone signals "Actuator KO"	An actuator does not respond: <ul style="list-style-type: none">- check whether the actuators are correctly connected and configured (test the actuators with the local key);- with standard configuration, check that the configuration has been performed correctly in the control unit (Maintenance>Configure zone>Configure).
A zone signals "Slave probe KO"	A slave probe does not respond: <ul style="list-style-type: none">- check whether it is correctly connected (green LED shining steadily or flashing slowly) and configured (correct zone number, SLA mode);- check the correct configuration of the slaves to be managed on the Master probe.
A zone signals "T out of limits"	The temperature measured by the probe is too low or too high: <ul style="list-style-type: none">- check that the probe is installed correctly (e.g. not too close to heat sources);- set the probe (Maintenance>Probe setting) measuring the room temperature with a thermometer;- if the problem continues, replace the probe.
A zone signals "R/W EEPROM KO"	If there is an internal problem on the probe, replace the probe.
A zone signals "Pump KO"	The actuator configured to control the circulation pump (Zone=00) does not respond: <ul style="list-style-type: none">- check that the actuator is correctly connected and configured (test the actuator with the local key);- check the correct configuration of the pump management on the probe.

Note



A series of horizontal dotted lines providing a template for writing notes.

Legrand reserves at any time the right to modify the contents of this booklet and to communicate, in any form and modality, the changes brought to the same.



**World Headquarters and
International Department**

87045 LIMOGES CEDEX FRANCE

☎: 33 5 55 06 87 87

Fax : 33 5 55 06 74 55

www.legrandelectric.com