

# Arteor™ RJ 45 socket outlet category 5e

Cat. Nos: 5723 03/04/15 - 5728 03/04/15  
5734 29/30/75 - 5736 29/30/75

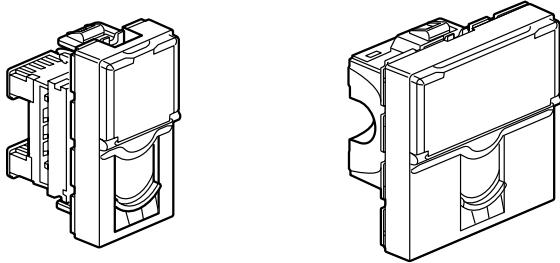

## CONTENTS

Page

1. Use.....	1
2. Range.....	1
3. Presentation.....	1
4. Preparation.....	1
5. Technical characteristics.....	1
6. Installation instructions.....	2
7. Dimensions.....	2
8. Standard RJ 45 connection.....	2
9. Performance.....	2-6
10. Standards and approvals.....	6

### 1. USE

Category 5e RJ 45 socket outlet.  
For high data rate transmissions (Gigabit Ethernet).

### 2. RANGE

	Description	Finishes		Module	Weight (g)
		White	Magnesium		
	RJ 45 cat. 5e UTP socket outlet	5723 03	5728 03	1	15
	RJ 45 cat. 5e UTP socket outlet	5734 29	5736 29	1	15
	RJ 45 cat 5e FTP socket outlet	5723 04	5728 04	1	15
	RJ 45 cat 5e FTP socket outlet	5734 30	5736 30	1	15
	RJ 45 cat. 5e UTP socket outlet	5723 15	5728 15	2	26
	RJ 45 cat. 5e UTP socket outlet	5734 75	5736 75	2	26

### 3. PRESENTATION

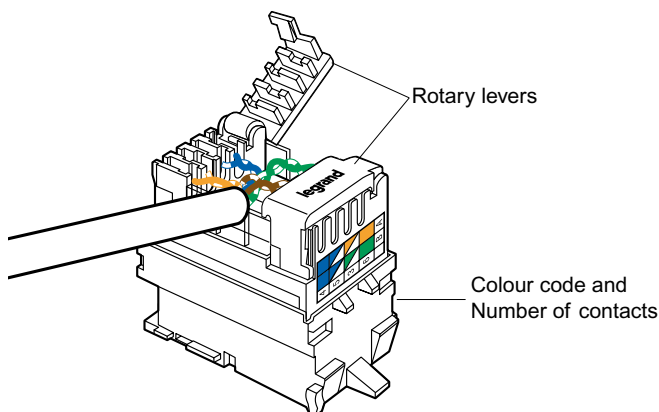

### 4. PREPARATION

The mechanisms can be flush-mounted or surface-mounted.

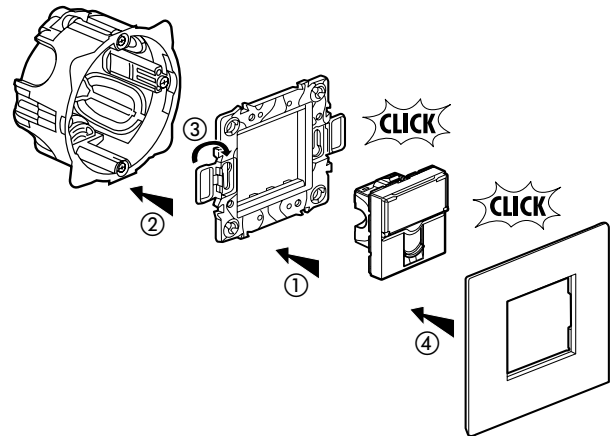

### 5. TECHNICAL CHARACTERISTICS

#### 5.1 Material characteristics

Contacts: gold /nickel plated, gold-plate thickness > 1.27 µm  
Metal parts: Bronze (CuSn5)  
Module insulator: ABS - Polycarbonate  
Cover plate: Polycarbonate

#### 5.2 Electrical characteristics

Breakdown voltage ≥ 1000 V.  
Contact resistance ≤ 20 mΩ.  
Insulation resistance ≤ 500 MΩ at 100 V DC.

#### 5.3 Mechanical characteristics

Max. number of connections and disconnections: 5 including 2 without refreshing the wire  
Endurance: 2500 operations (plugging in/unplugging)  
Impact tests: IK02

#### 5.4 Climatic characteristics

Operating temperatures : - 40° C to + 70° C  
Damp heat cycle 6 days.  
Resistance to gases (H<sub>2</sub>S and SO<sub>2</sub>).

# Arteor™ RJ 45 socket outlet category 5e

Cat. Nos: 5723 03/04/15 - 5728 03/04/15  
5734 29/30/75 - 5736 29/30/75

## 6. INSTALLATION INSTRUCTIONS

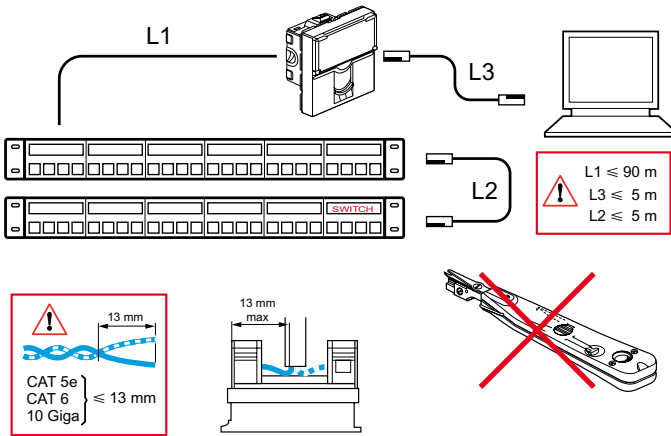

## 7. DIMENSIONS

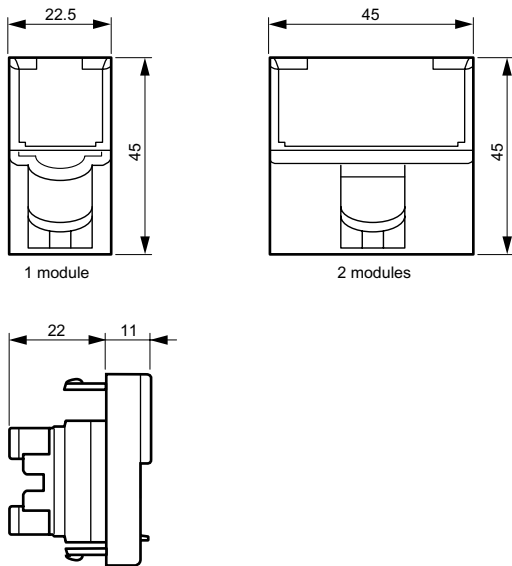

## 8. STANDARD RJ 45 CONNECTION

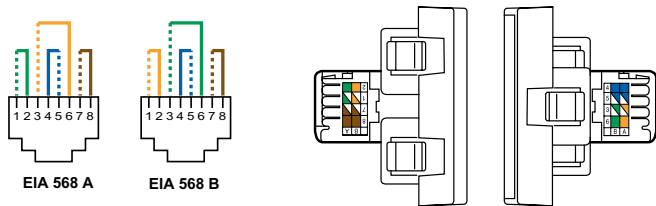

## 9. PERFORMANCE

### 9.1 Component performance (RJ 45 connectors)

#### Return loss

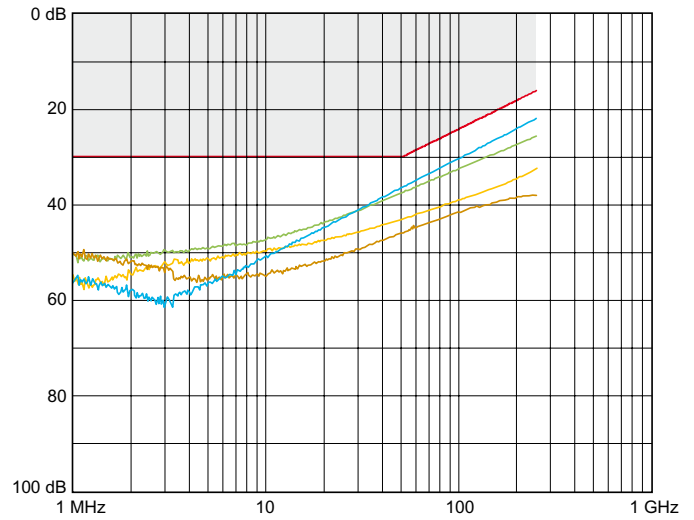

#### Attenuation

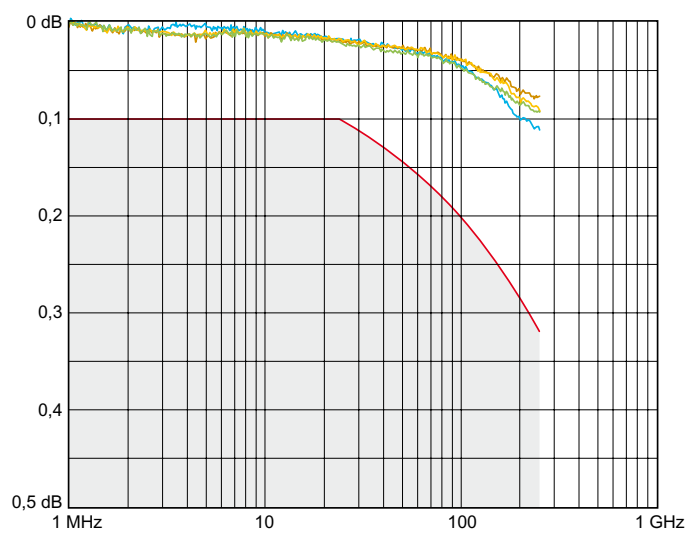

#### NEXT (Near end Crosstalk Attenuation)

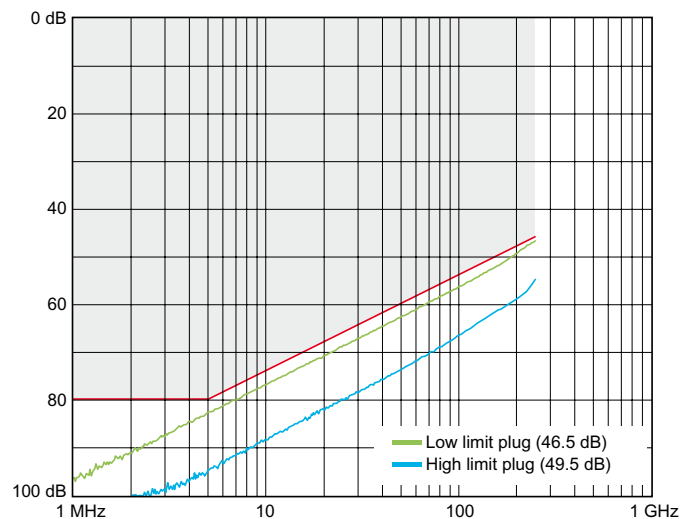

**9. PERFORMANCE (cont'd)**

**9.1 Component performance (RJ 45 connectors) (cont'd)**  
 FEXT (Far end Crosstalk Attenuation)

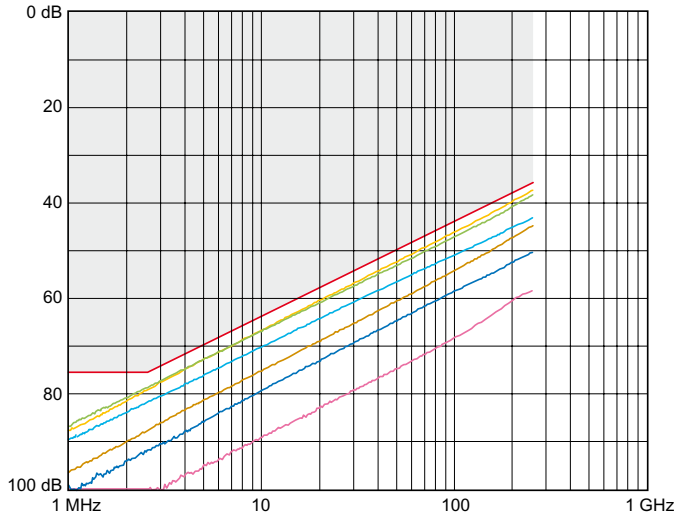

TCL (Transversal Conversion Loss)

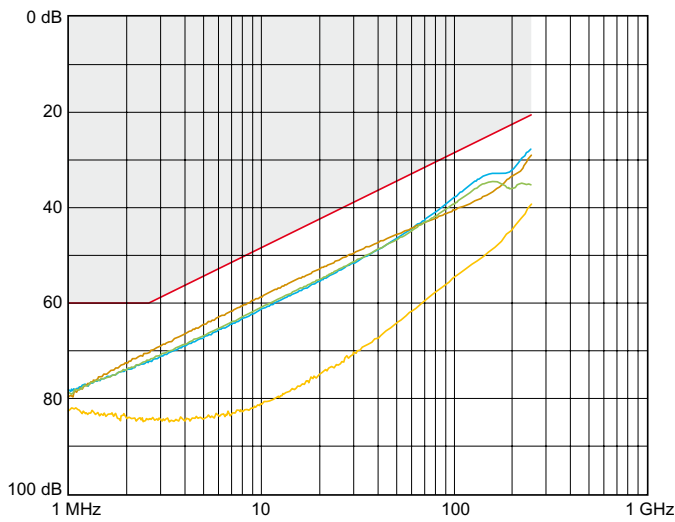

**9.2 Permanent link performance**

Return loss

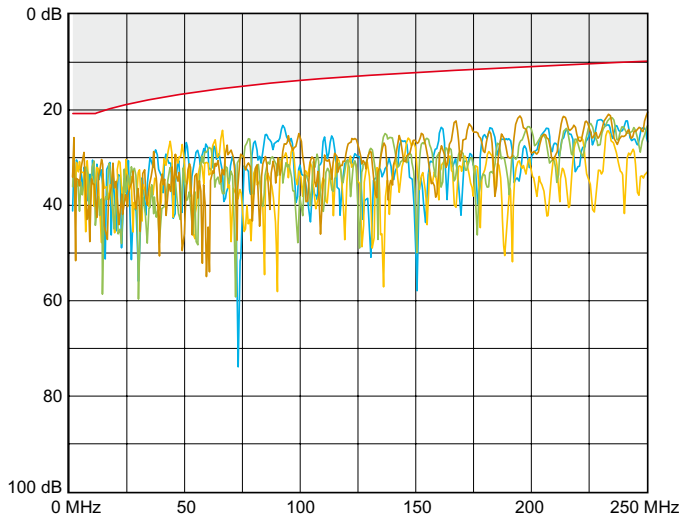

**9. PERFORMANCE (cont'd)**

**9.2 Permanent link performance (cont'd)**  
 NEXT (Near end Crosstalk Attenuation)

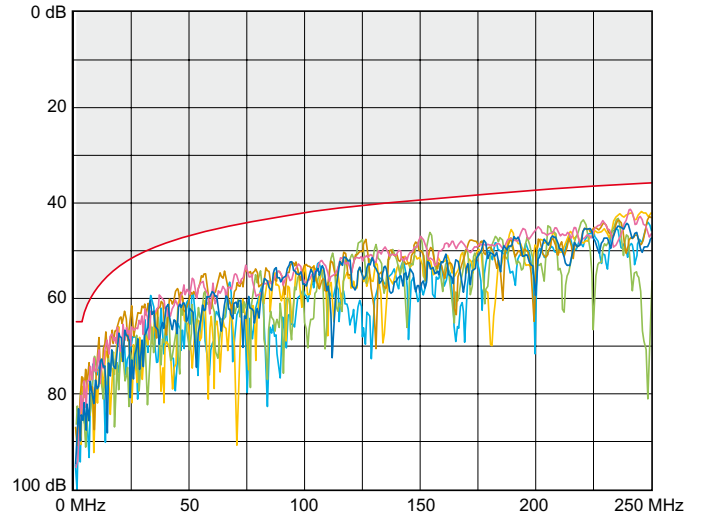

PS NEXT (Power sum NEXT)

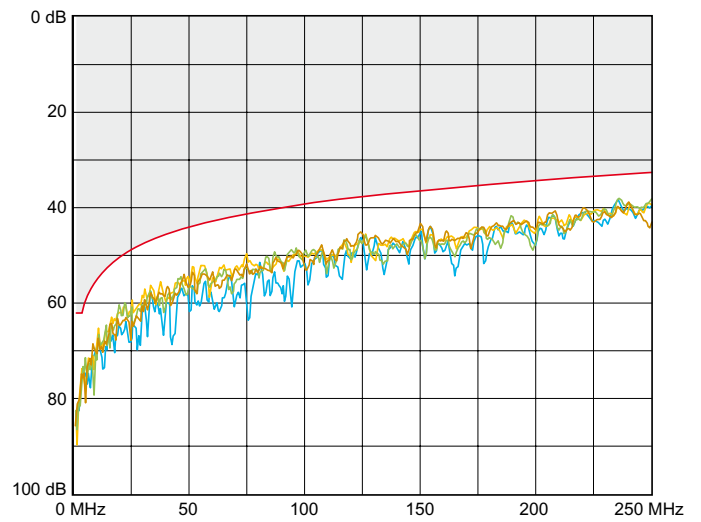

ACR (Attenuation to Crosstalk Ratio)

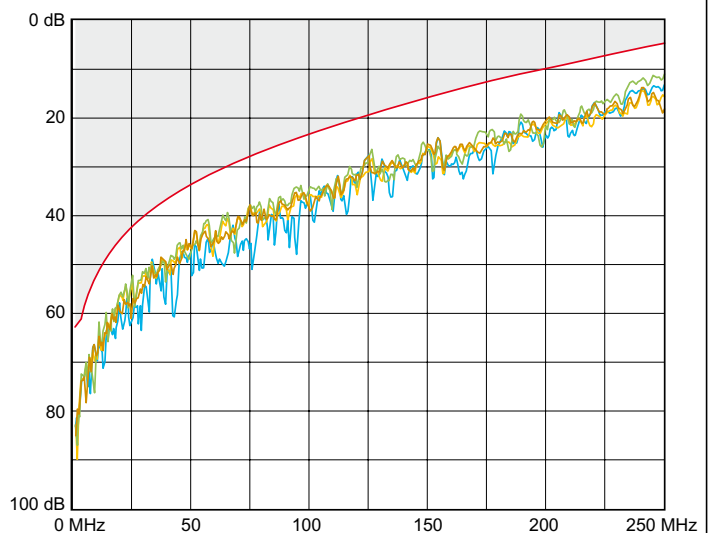

**9. PERFORMANCE (cont'd)**

**9.2 Permanent link performance (cont'd)**  
 PS ACR (Power Sum ACR)

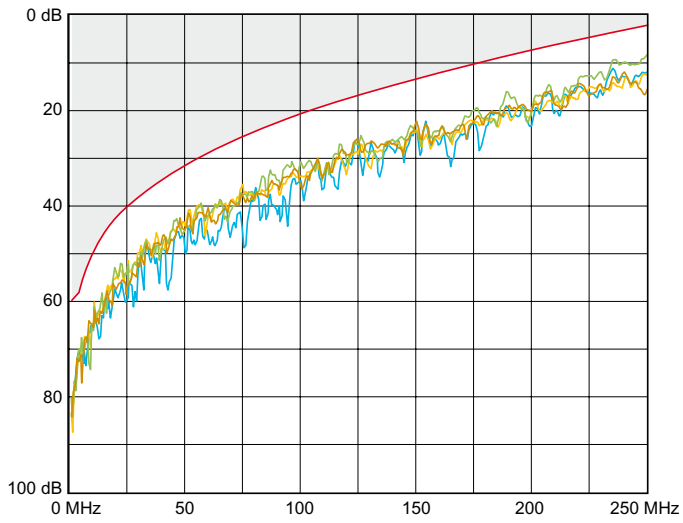

**ELFEXT (Equal Level FEXT)**

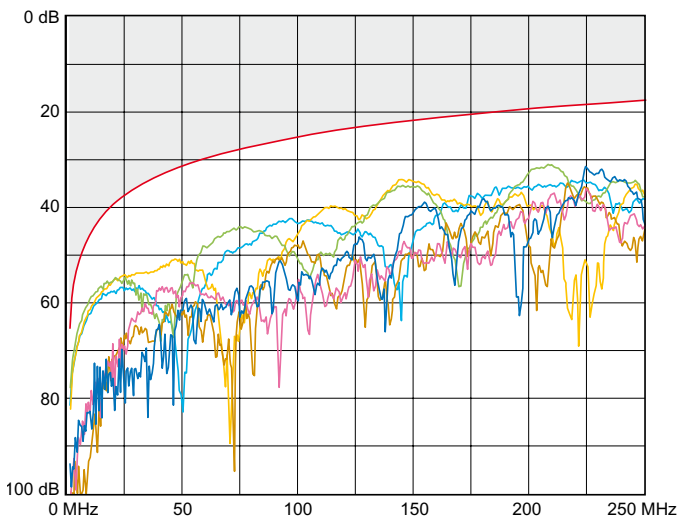

**PS ELFEXT (Power Sum ELFEXT)**

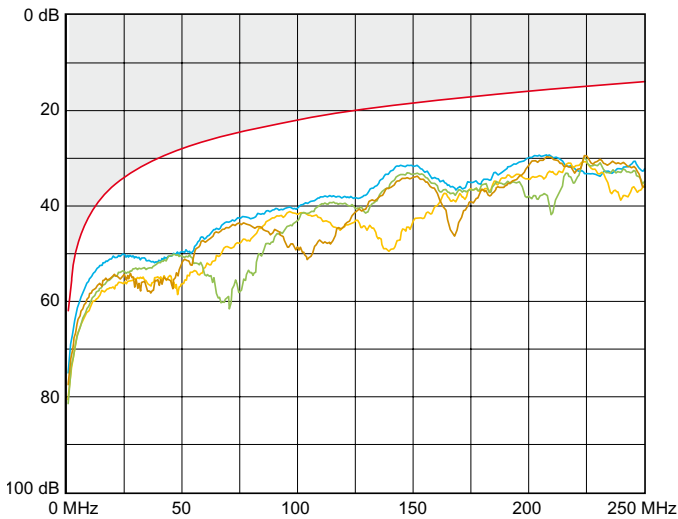

**9. PERFORMANCE (cont'd)**

**9.2 Permanent link performance (cont'd)**  
 Propagation delay

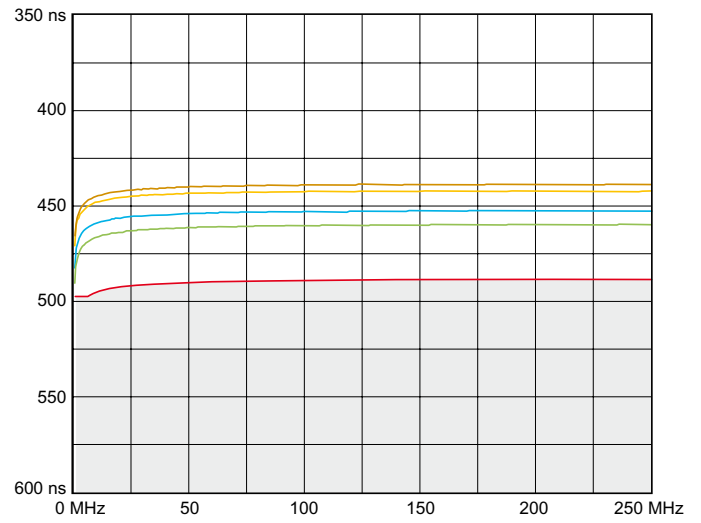

**Delay skew**

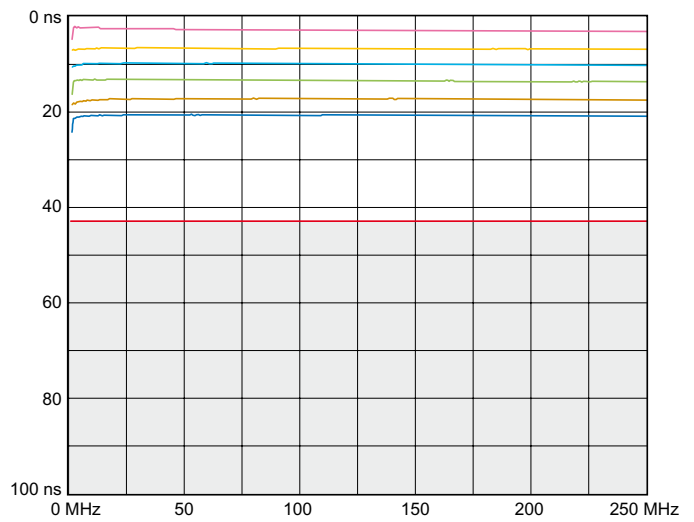

**LCL (Longitudinal Conversion Loss)**

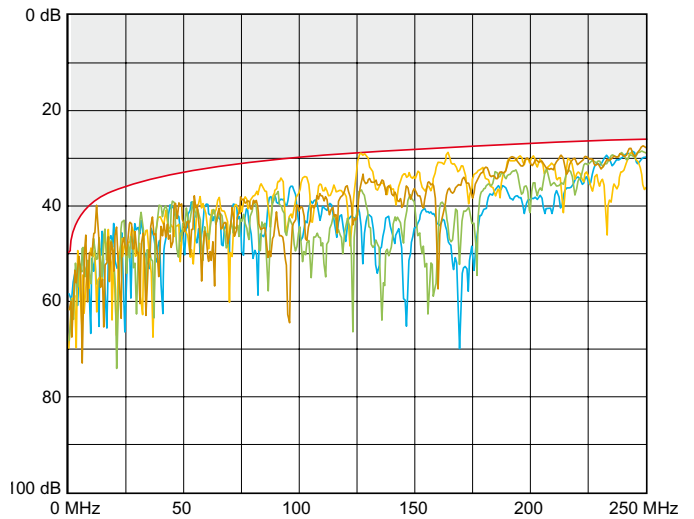

**9. PERFORMANCE (cont'd)**

**9.3 Channel performance**  
 Return loss

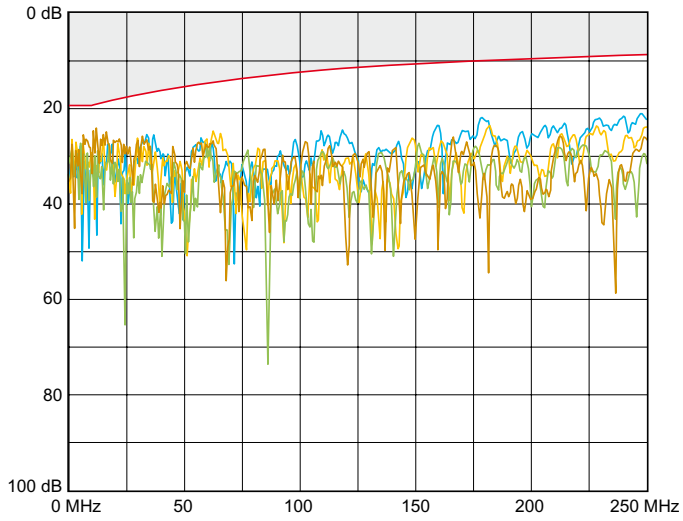

**NEXT (Near end Crosstalk Attenuation)**

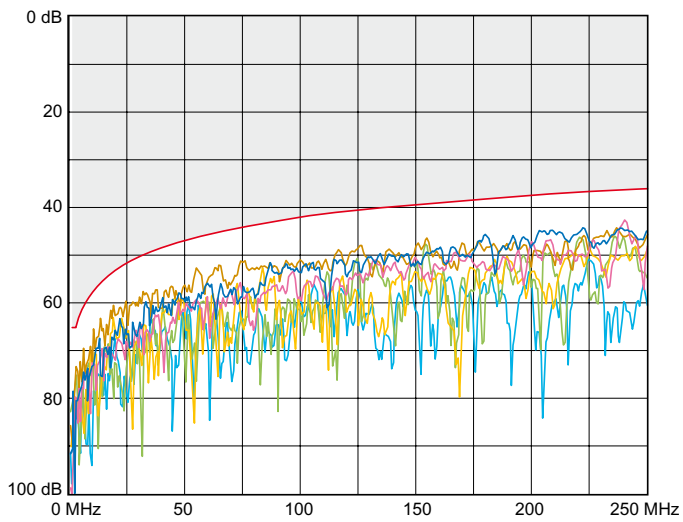

**ACR (Attenuation to Crosstalk Ratio)**

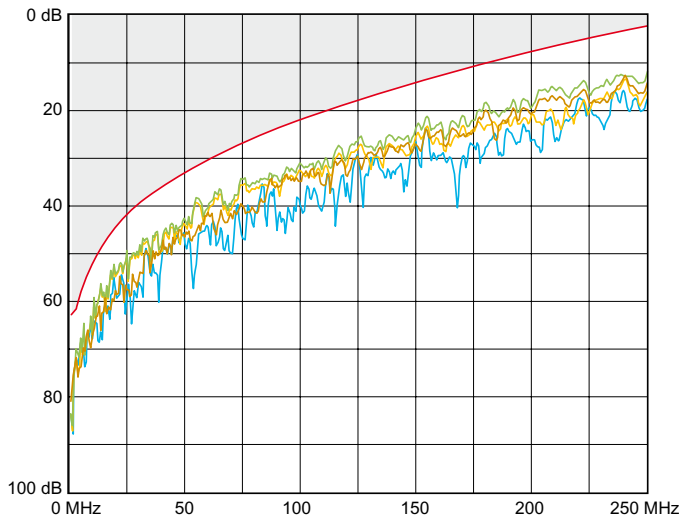

**9. PERFORMANCE (cont'd)**

**9.3 Channel performance (cont'd)**  
 PS ACR (Power sum ACR)

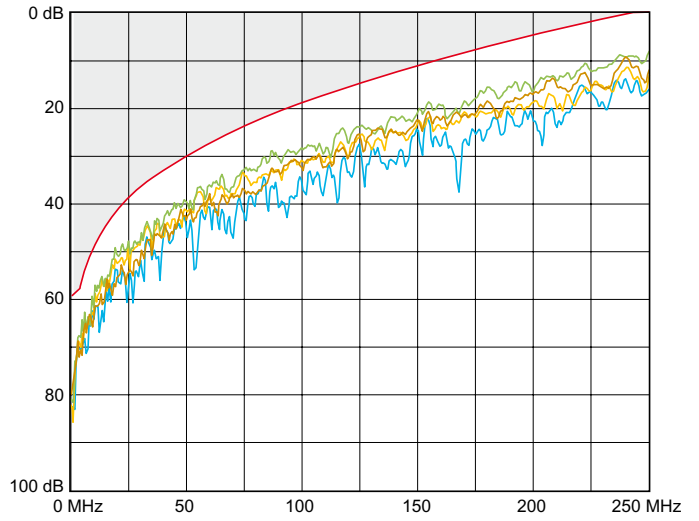

**ELFEXT (Equal Level FEXT)**

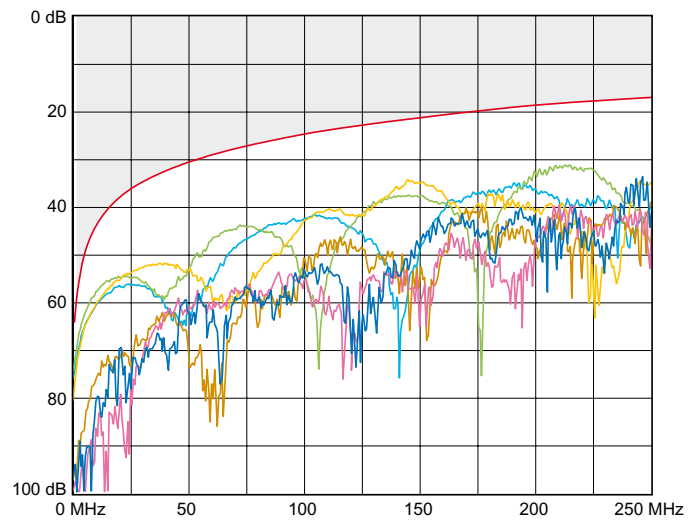

**PS ELFEXT (Power sum ELFEXT)**

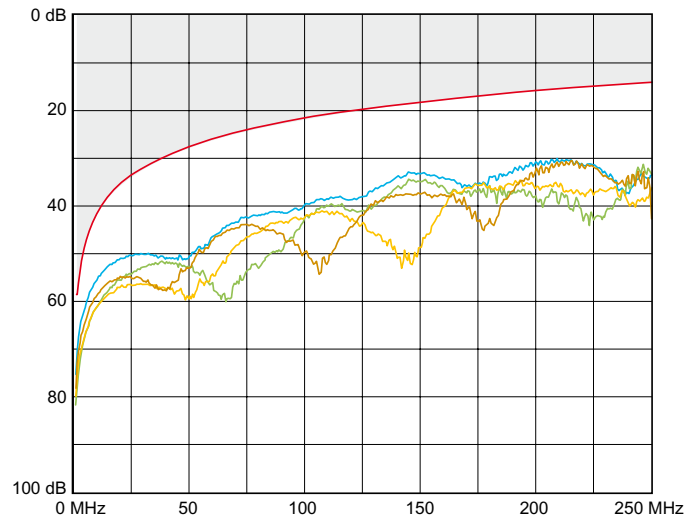

**9. PERFORMANCE (cont'd)**

**9.3 Channel performance (cont'd)**

Propagation delay

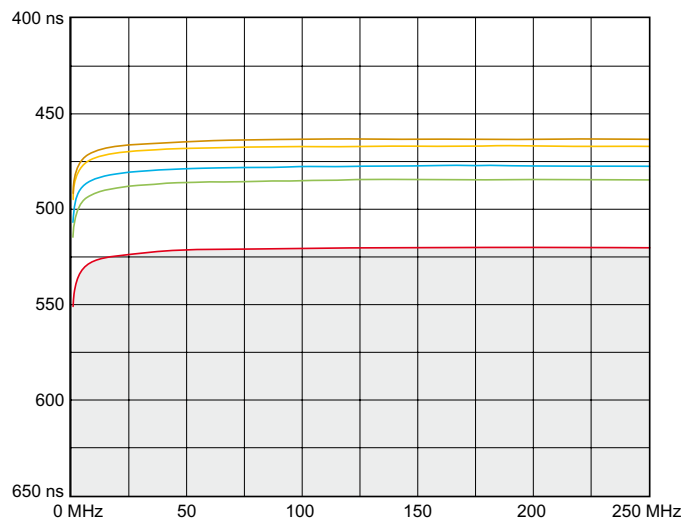

Delay skew

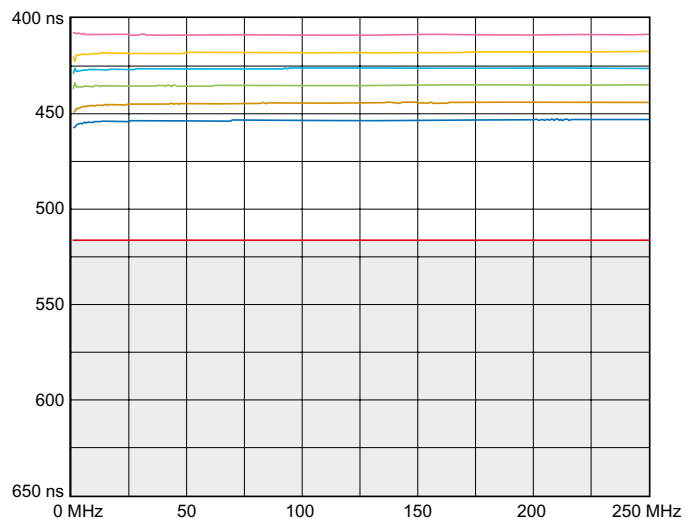

LCL (Longitudinal Conversion Loss)

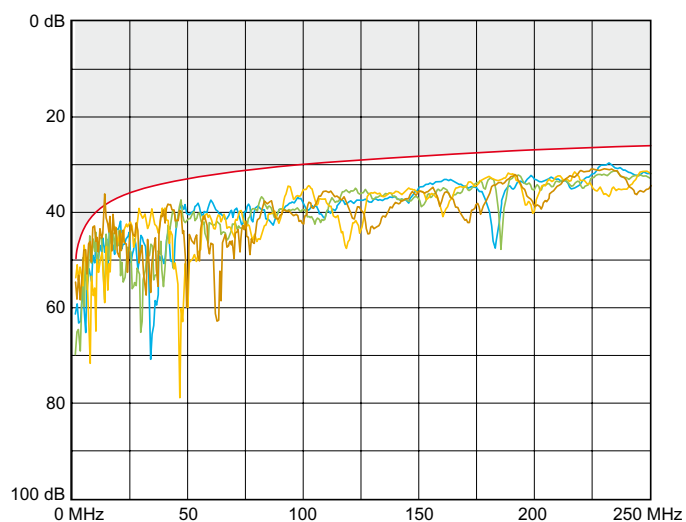

**10. STANDARDS AND APPROVALS**

Conform with the following standards  
 ISO 11 801 Second Edition  
 EN 50 173 Second Edition  
 EIA / TIA - 568 - B.2  
 NFC 20 730  
 Standard 8877 - 603.7  
 Approval No. 3P : 102 180