

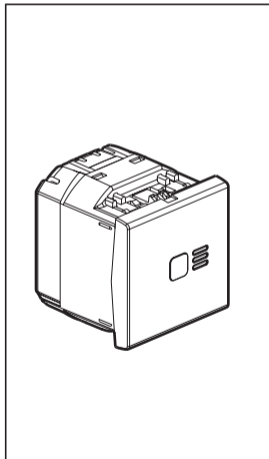

2500 W PLC/IR switch
7358 11 - 7359 11



Characteristics

	①	②	③	④	⑤
				 Ø 26 Ø 38	
110 V	1250 W	1250 W	1250 VA	8 x 36 W	250 W
230 V	2500 W	2500 W	2500 VA	8 x 36 VA	500 W

① Incandescent lamp

② Halogen lamp

③ ELV halogen lamp with ferromagnetic or electronic transformer (*)



④ Fluorescent tube (*)

⑤ Fluocompact lamp with built-in or separate transformer (*)

(*) with filter

Note : can be relayed using a contactor for higher powers

Characteristics *(continued)*

Voltage	100 - 240 VA
Frequency	50 - 60 Hz
	2 x 1.5 mm ²
Standards	EN 50065 IEC 60669-2-1
	- 5° C to + 45° C

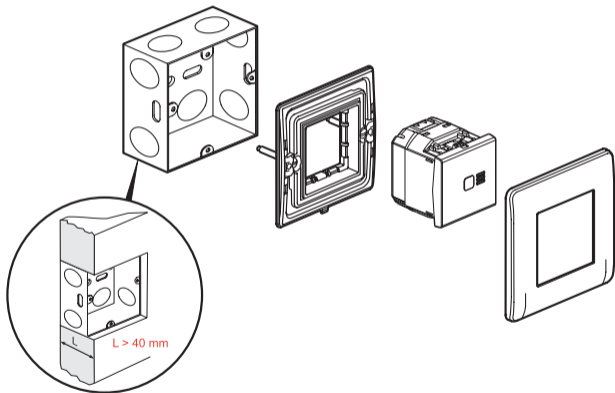

Wiring

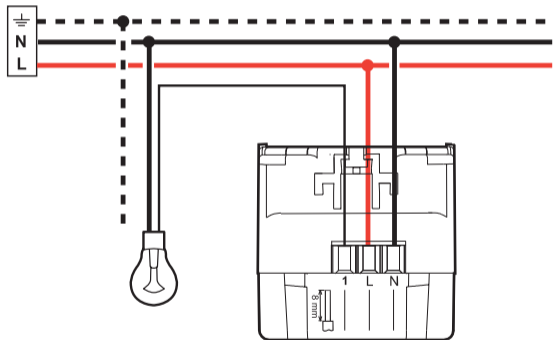

Safety instructions :

This product should be installed preferably by a qualified electrician. Incorrect installation and use can entail risk of electric shock or fire.

Before carrying out the installation, read the instructions and take account of the product's specific mounting location.

Do not open up the device. All Legrand products must be exclusively opened and repaired by personnel trained and approved by LEGRAND. Any unauthorised opening or repair completely cancels all liabilities and the rights to replacement and guarantees.

Only use genuine accessories.

Description

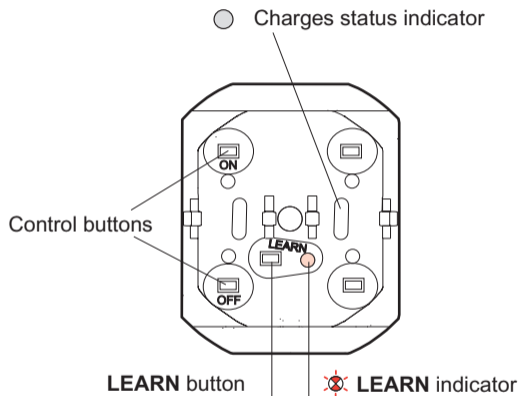

Factory setting

When first powered up, the ON or OFF buttons are pressed to control all the lighting points of the «In One by Legrand» installation. This option is provided so that the correct operation and connection of all the lighting fittings can be checked.

Pressing LEARN⁽¹⁾ twice cancels this general control function.

⁽¹⁾ Programming or learning button.

Operation

Example : creating a scenario.

Control switching (L1) using the ON button on a lighting scenario switch.

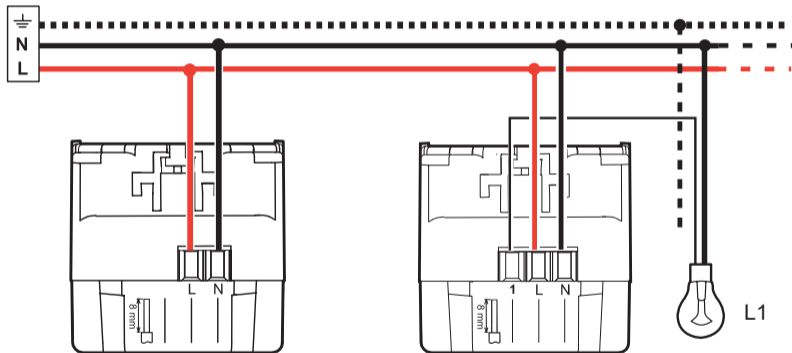

Transmitter

Lighting scenario switch

Cat. Nos. : 7358 18 - 7359 18

Receiver

2500 W switch

Cat. Nos. : 7358 11 - 7359 11

Key



The indicator light switches off



The indicator light flashes slowly













The indicator light flashes quickly









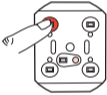

The indicator light flashes

Operation *(continued)*

Transmitter	LEARN Indicator	Receiver(s)	LEARN Indicator	L1
1 Open the scenario 				
2 				
		3 		

Operation *(continued)*

Transmitter	LEARN Indicator	Receiver(s)	LEARN Indicator	L1
		<p data-bbox="774 484 819 529">4</p> 		
<p data-bbox="94 612 1155 640">To add several products to the scenario, repeat operations 3 and 4 for each receiver.</p>				
<p data-bbox="119 733 393 767">5 Save the scenario</p> 				

The learning step is completed : L1 switch-on and switch-off can now be triggered independently from either the lighting scenario switch or the 2500 W switch.

Operation *(continued)*

Example : changing scenario 1 of a scenario switch

Delete the switch-on command on the 2500-W switch in a scenario.

Control switching-off the 2500-W switch.

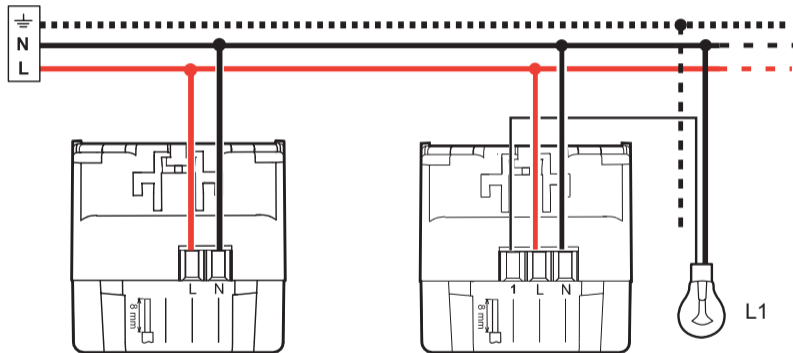

Transmitter

Scenario switch











Cat. Nos. : 7758 19 - 7359 19

Receiver

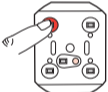









2500 W switch

Cat. No. : 7358 11 - 7359 11

Operation *(continued)*

Transmitter	LEARN Indicator	Receiver(s)	LEARN Indicator	L1
1 Open the scenario 				
2 		All the scenario products blink		
		3  Option of deleting the product from the scenario by jumping to operation 6 .		

Operation *(continued)*

Transmitter	LEARN Indicator	Receiver(s)	LEARN Indicator	L1
		<p>4 Add the products to be included into the scenario</p> 		
		<p>5</p> 		
<p>6 Save the scenario</p> 				

The scenario has been modified : from now on, the scenario will switch off L1.

Operation *(continued)*

labelling a control button from all scenarios (on the Receiver)



labelling a receiver from all scenarios (on the Receiver)

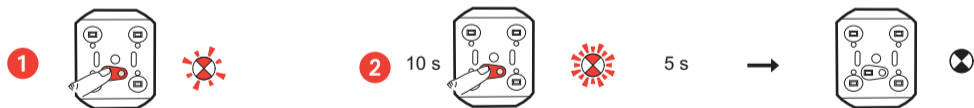

Product returns
to factory settings.

Operation *(continued)*

Problem	Cause	Solution
The learn indicator light comes on for 5 seconds.	Learning is impossible.	Install compatible products.
The learn indicator light comes on for 10 seconds.	The number of saved transmitters is more than 32.	Delete the unused scenarios.
During learning the learn indicator light stops blinking.	The learning mode shuts down after 10 minutes.	Restart the learning.
The programmed function button does not work.	After pressing the learn button, the learning of the function button is done in the minute that follows.	Restart the learning.
On saving the scenario, the learn indicator lights of some receivers do not go off.	Incorrect communication between the products.	Check the cabling (connection). Look for a possible interference device*. Insulate with a filter.

*Example of interference device : electronic transformer, switch mode power supply,...