

Arteor™ 6 A push-buttons

Cat. No(s): 572 000/001/030/031 - 572 500/501/530/531
573 000/001/002/050/051 - 573 100/101/102/150/151

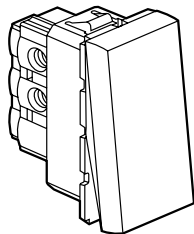

572 000/500

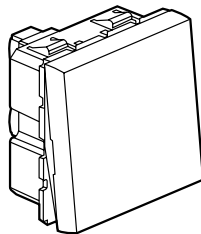

572 030/031/530/531

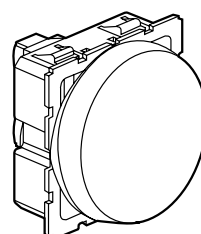









573 050/51/150/151

1. USE

General lighting control mechanisms.

2. RANGE

	Designation	Finishes.		No. of modules	Connection method	Weight (g)	Characteristics
		White	Magnesium				
	One-way push-button (square)	572 000	572 500	1	with screws	21	6 A - 250 VAC
	Two-way push-button (square)	572 001	5725 01	1	with screws	23,8	6 A - 250 VAC
	One-way push-button (square)	5720 30	572 530	2	with screws	29,2	6 A - 250 VAC
	Two-way push-button (square)	572 031	572 531	2	with screws	31,9	6 A - 250 VAC
	One-way push-button (round left)	573 000	573 100	1	with screws	20,3	6 A - 250 VAC
	One-way push-button (middle)	573 001	573 101	1	with screws	20,9	6 A - 250 VAC
	One-way push-button (round right)	573 002	573 102	1	with screws	20,3	6 A - 250 VAC
	One-way push-button (round)	573 050	573 150	2	with screws	27,8	6 A - 250 VAC
	Two-way push-button (round)	573 051	573 151	2	with screws	30,5	6 A - 250 VAC

Arteor™

6 A push-buttons

Cat. No(s): 572 000/001/030/031 - 572 500/501/530/531
573 000/001/002/050/051 - 573 100/101/102/150/151

3. PREPARATION

The mechanisms can be flush-mounted or surface-mounted.

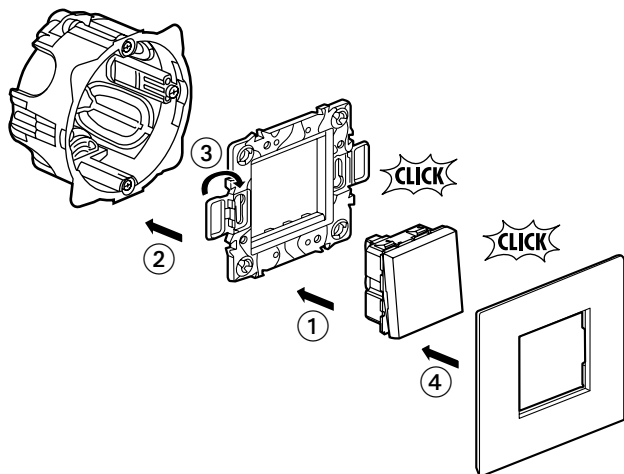

4. OVERALL DIMENSIONS

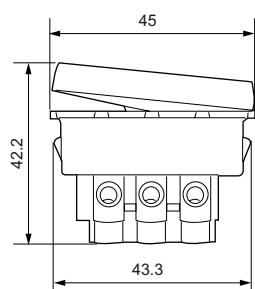
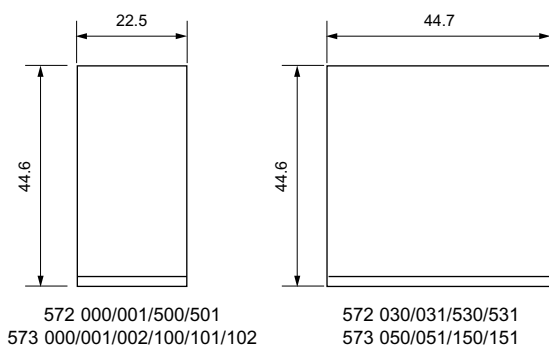

5. CONNECTION

Terminals: with screws
Capacity: 2 x 2.5 mm² or 1 x 4 mm²
Stripping: 10 mm
Screwdriver: 4 mm flat-blade up to 5.5 mm

6. OPERATION

Push button mechanism.

7. TECHNICAL CHARACTERISTICS

7.1 Mechanical characteristics

Impact tests: IK 04
Protection by solid bodies/liquids: IP 40 (mounted)
IP 20 (alone)

7.2 Material characteristics

Rocker: Polycarbonate
Base: Polycarbonate
Basket: Polypropylene

7.3 Electrical characteristics

Voltage: 250 VAC
Current: 6 A
Self-extinguishing: 650° C / 30 s

7.4 Climatic characteristics

Storage temperatures: - 10° C to + 70° C
Operating temperatures: - 5° C to + 50° C

8. CLEANING

Surface cleaning with a cloth.
Do not use: acetone, tar remover, trichloroethylene.

Resistance to the following cleaning agents: Hexane (EN 60669-1), Methylated spirits, Soapy water, Diluted ammonia, Diluted pure bleach 10%, Glass cleaning substance, Pre-impregnated wipes.

Caution: A preliminary test should be carried out if other specific cleaning products are to be used.

9. CONFORMITY - APPROVALS

Approvals in process:

	IECEE	SABS	PAI	PSB	SONCAP	KEN
572 000 572 500	x	x	x	x		
572 001 572 501	x	x	x	x	x	x
572 030 572 530	x	x	x	x	x	x
572 031 572 531	x	x		x		
573 000 573 100	x	x	x	x		
573 001 573 101	x	x	x	x		
573 002 573 102	x	x	x	x		
573 050 573 150	x	x	x	x		
573 051 573 151	x	x		x		