

Datasheet



E3 LED Edgelight



CAT. NO. 659056LI, 659057LI, 659058LI, 659059LI, 659060LI, 659061LI, 659062LI, 659063LI, 659064LI, 659074LI, 659075LI, 659076LI, 659077LI, 659078LI, 659079LI, 659080LI, 659081LI, 659082LI



659057LI

Operating Mode	Maintained
Nominal Input Voltage	230 - 240 V a.c. 50 Hz
Battery	Li-ion 6.4 V 0.57 Ah
Power Consumption	3 W
Inrush Current	5 A peak
Light Source Life (LSL)	50,000 hrs
Operating Temperature	10° C to 40° C
Body Construction	Stainless steel wall plate and Steel for Surface Mounting Block
Diffuser Construction	Acrylic
IP Rating	IP20
Compliance	AS/NZS 2293, AS/NZS 60598, AS CISPR 15
Product Marking	  R-NZ



E3 LED Edgelight

CAT. NO. 659056LI, 659057LI, 659058LI, 659059LI, 659060LI, 659061LI, 659062LI, 659063LI, 659064LI, 659074LI, 659075LI, 659076LI, 659077LI, 659078LI, 659079LI, 659080LI, 659081LI, 659082LI



FEATURES

- Embedded Bluetooth for smart device connectivity.
- Low power Wide Area Network type of communications utilising the LoRa platform.
- LoRa communication to maximise reliability, coverage and infiltration.
- Internally illuminated sign with no classification.
- SPU or Axiom wireless computer-monitored.
- Recessed or Surface Mounted.
- Modern and sleek design.
- iSmart™ temperature sensing technology for the Li-ion battery.
- Electronics designed to lengthen the life of the battery, minimising maintenance costs.
- Environment friendly battery.
- 5 Year Warranty.
- Designed and Manufactured in Australia.

DIMENSIONS

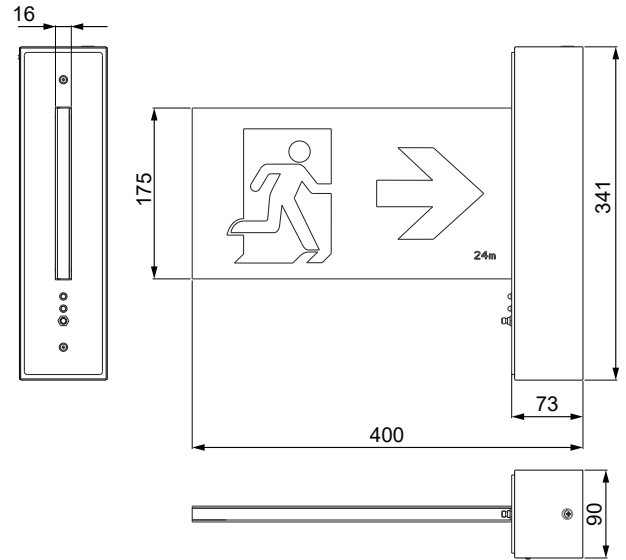

Surface Mount

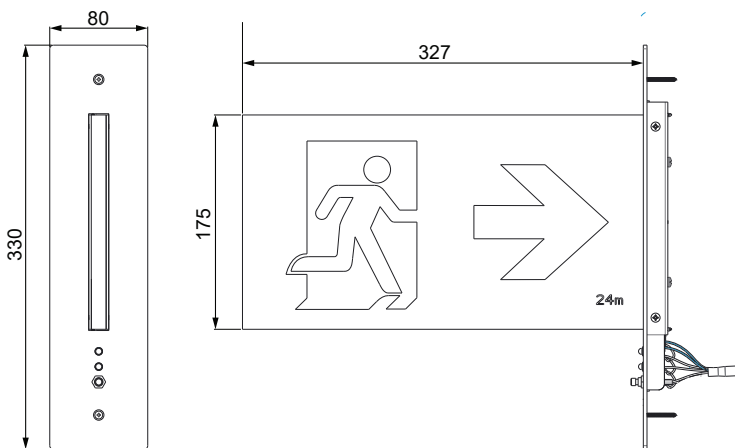

Recessed

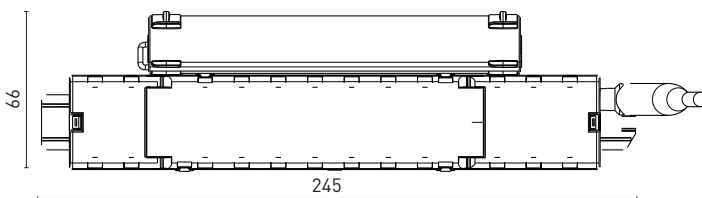

Galaxy Power pack

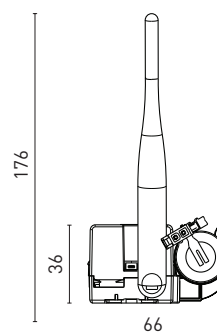









NOTE: All dimensions are in mm.

E3 LED Edgelight

CAT. NO. 659056LI, 659057LI, 659058LI, 659059LI, 659060LI, 659061LI, 659062LI, 659063LI, 659064LI, 659074LI, 659075LI, 659076LI, 659077LI, 659078LI, 659079LI, 659080LI, 659081LI, 659082LI



RECESSED	SURFACE MOUNT		
Cat.No		Description	
659056LI	659074LI	E3 LED – wall to left – Single Sided – RMS	
659057LI	659075LI	E3 LED – wall to left – Single Sided – RML	
659058LI	659076LI	E3 LED – wall to left – Single Sided – RMR	
659062LI	659080LI	E3 LED – wall to right – Single Sided– RMS	
659063LI	659081LI	E3 LED – wall to right – Single Sided – RML	
659064LI	659082LI	E3 LED – wall to right – Single Sided– RMR	
659059LI	659077LI	E3 LED – wall to left – Double Sided – RMS	
659060LI	659078LI	E3 LED – wall to left – Double Sided – RMLR	
659061LI	659079LI	E3 LED – wall to left – Double Sided – RMLR	

RMS = Running Man Straight, RML = Running Man Left, RMR = Running Man Right, RMLR= Running Man Left/Right

Legrand Australia
1300 369 777
www.legrand.com.au
ABN 31 000 102 661

Legrand New Zealand
0800 476 009
www.legrand.co.nz

Refer to your group buying office, Legrand Sales Representative or Legrand Sales Office for pricing.

Please note: specifications are subject to change without prior notice.

